

# Motor Development Kit (MDK) 4 kW Board with Intelligent Power Module SPM31 650 V



ON Semiconductor®

[www.onsemi.com](http://www.onsemi.com)

## SECO-MDK-4KW-65SPM31-GEVB

### EVAL BOARD USER'S MANUAL

#### Description

The SECO-MDK-4KW-65SPM31-GEVB is a development board for three-phase motor drives, part of the Motor Development Kit (MDK). The board features the *NFAM5065LAB* Intelligent Power Module in a DIP39 package and is rated for 400 Vdc input, delivering continuous power in excess of 1 kW, with the capability of delivering up to 4 kW power for a short period. The board is fully compatible with the *Universal Controller Board (UCB)*, based on the Xilinx Zynq-7000 SoC, which embeds FPGA logic and two Arm® Cortex®-A9 processors. As such, the system is fit for high-end control strategies and enables operation of a variety of motor technologies (AC induction motor, PMSM, BLDC, etc.).

#### Features

- 4 kW Motor Control Solution Supplied with up to 410 Vdc
- Compatible with the Universal Controller Board (UCB) FPGA-controller Based on Xilinx Zynq-7000 SoC
- Out of the Box Use Cases for FOC and V/F Control with Graphical User Interface (GUI)
- Highly Integrated Power Module *NFAM5065LAB* 650 V/50 A High Voltage 3-phase Inverter in a DIP39 Package
- DC/DC Converter Producing Auxiliary Power Supply 15 Vdc – Non-isolated Buck Converter using *NCP1063*, DC/DC Converter Producing Auxiliary Power Supply 5 Vdc – Non-isolated Buck Converter using *FAN8303*, and LDO Producing Auxiliary Power Supply 3.3 Vdc – using *NCP718*
- Three-phase Current Measurement using 3 x *NCS20166* Operational Amplifiers
- Three-phase Inverter Voltage and DC-Link Voltage Measurement – using Resistive Voltage Divider Circuit
- 512 kB EEPROM I<sup>2</sup>C – using *CAT24C512*
- Encoder Interface Compatible with either 3-HALL Sensors 1 Channel Quadrature Encoder
- Temperature Sensing via Build in Thermistor
- Over Current Protection using *NCS2250* Comparator

#### Applications

- White Goods
- Industrial Fans
- Industrial Automation
- Industrial Motor Control

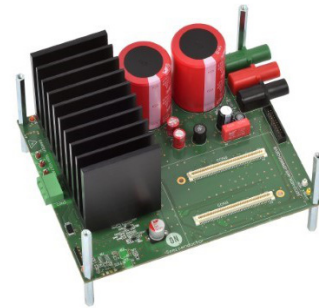

Figure 1. SECO-MDK-4KW-65SPM31-GEVB

#### Collateral

- [SECO-MDK-4KW-65SPM31-GEVB](#)
- [Universal Control Board \(UCB\)](#) [1]
- [NFAM5065LAB \(IPM\)](#) [2]
- [NCP1063 \(15 V non-isolated buck\)](#) [3]
- [FAN8303 \(5 V non-isolated buck\)](#) [4]
- [NCP718 \(3.3 V LDO\)](#) [5]
- [NCS20166](#) [6]  
(Op-Amp for Current Measurement)
- [NCS2250](#) [7]  
(Comparator for Over-current Protection)
- [CAT24C512 \(EEPROM\)](#) [8]

# SECO-MDK-4KW-65SPM31-GEVB

## Scope and Purpose

This user guide provides practical guidelines for using and implementing a three-phase industrial motor driver with the Intelligent Power Module (IPM). The design was tested as described in this document but not qualified regarding safety requirements or manufacturing and operation over the entire operating temperature range or lifetime. The development board has been layout in a spacious manner so that it facilitates measurements and probing for the evaluation of the system and its components. The hardware is intended for functional testing under laboratory conditions and by trained specialists only.

**Hardware Revision** – this user manual is compatible with version 1.0 *SECO-MDK-4KW-65SPM31-GEVB*.

**Attention:** The *SECO-MDK-4KW-65SPM31-GEVB* is exposed to high voltage. Only trained personnel should manipulate and operate on the system. Ensure that all boards are properly connected before powering, and that power is

off before disconnecting any boards. *It is mandatory to read the Safety Precautions section before manipulating the board.* Failure to comply with the described safety precautions may result in personal injury or death, or equipment damage.

## Prerequisites

All downloadable files are available on the board website.

- Hardware
  - ◆ SECO-MDK-4KW-65SPM31-GEVB
  - ◆ DC power supply (includes earth connection)
  - ◆ Universal Control Board (UCB)
  - ◆ USB isolator (5 kV optical isolation, also see [Test Procedure](#))
- Software
  - ◆ Downloadable GUI
  - ◆ Downloadable UCB motor control firmware as boot image

## DESIGN OVERVIEW

This report aims to provide the user manual for the development board SECO-MDK-4KW-65SPM31-GEVB. This development board (from here on *MDK\_SPM31*) is a DC supplied three-phase motor drive inverter intended for industrial motion applications < 4 kW range. In this field, a trade-off between switching frequency and power management is the key to fulfil the requirements while providing a simple and robust solution. The system is compatible with three phase motors (BLDC, Induction, PMSM, Switched Reluctance etc.). The *MDK\_SPM31* power board is illustrated in Figures 2 and 3 (top and bottom

view, respectively). The block diagram of the whole system is depicted in Figure 4.

The foremost advantages that this development board brings are:

- System solution for industrial motor control applications
- Low component count with integrated IGBT power module
- Design fit for different motor technologies
- Friendly user experience with Graphical User Interface and selectable open loop/FOC closed loop control
- Rapid evaluation close to application condition

# SECO-MDK-4KW-65SPM31-GEVB

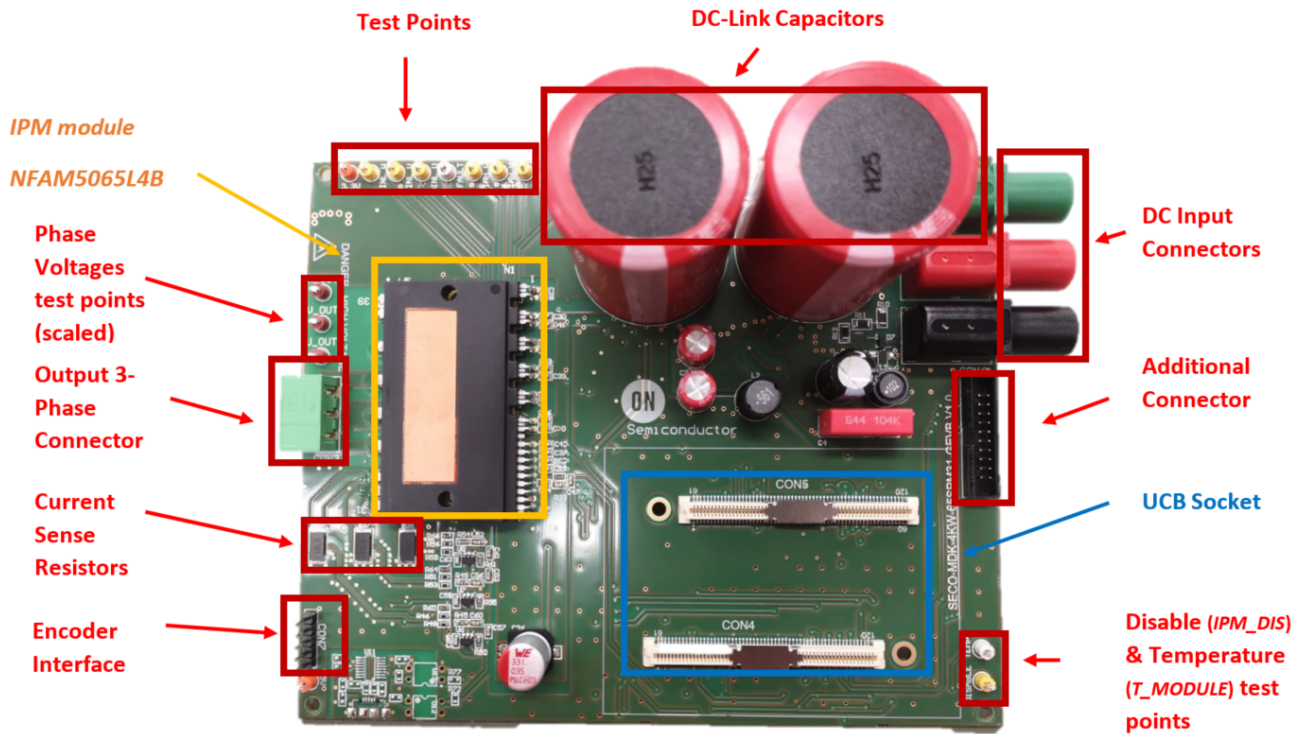

Figure 2. Picture of SECO-MDK-4KW-65SPM31-GEVB Board – Top Side

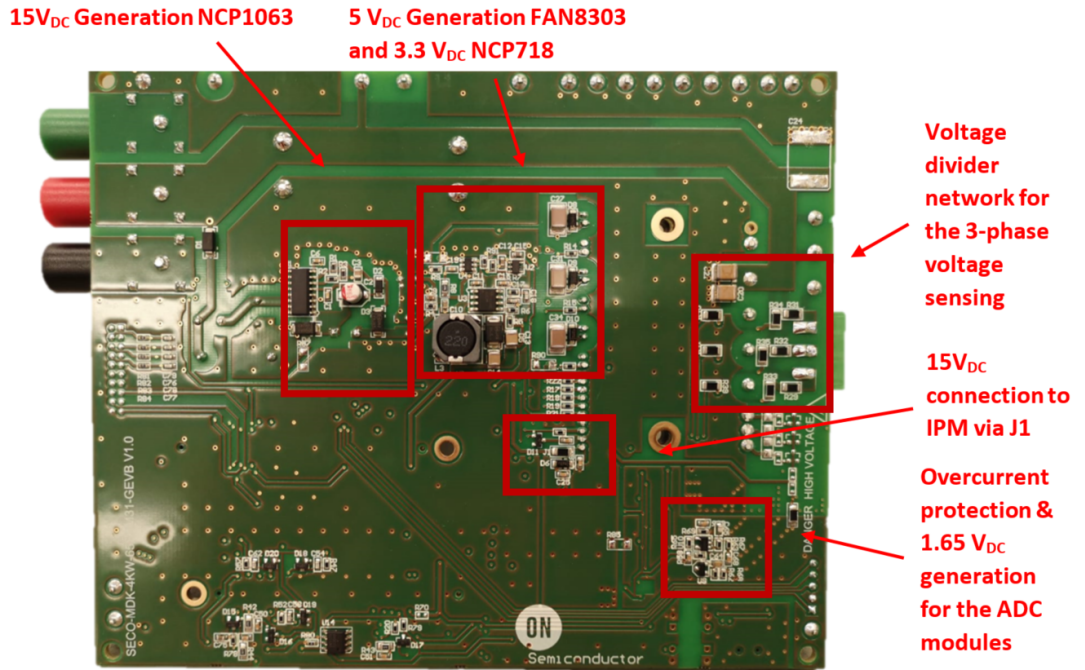

Figure 3. Picture of SECO-MDK-4KW-65SPM31-GEVB – Bottom Side

# SECO-MDK-4KW-65SPM31-GEVB

## SPECIFICATION

The specification and main features are elaborated in Table 1.

**Table 1. MDK\_SPM31 SPECIFICATIONS**

Parameters	Values	Conditions/Comments
<b>INPUT</b>		
Voltage DC	200–400 Vdc	Absolute maximum input voltage 410 V
<b>OUTPUT</b>		
Power	1 kW (continues)	Input 200–400 Vdc
	4 kW (short period)	Maximum operation period 15 min @ Ta = 25°C
Current per IPM Leg	±2.5 Arms / 1 kW (140 Vrms Phase voltage and PF 0.98)	Lower output phase voltage will result in higher phase currents for same power
Module Temperature at 25°C Ambient	T <sub>C</sub> = 65°C after 25 min @ 400 Vdc / 1 kW	Measured @ F <sub>PWM</sub> = 16 kHz; lower frequency will result to higher ripple currents which might increase temperature
	T <sub>C</sub> = 83°C after 8 min @ 400 Vdc / 4 kW	
<b>CURRENT FEEDBACK</b>		
Current Sensing Resistors	10 mΩ	Three 10 mΩ, one for each phase
Op–Amp Power Supply	3.3 V	Generated by the <i>NCP718 LDO</i>
Op–Amp Gain	10	Via resistors
Op–Amp Output Offset	1.65 V	Because of negative current measurement requirement
Current Measurement Resolution	0.016 A / bit	Based on <i>UCB</i> integrated 11 bits ADC <i>NCD98011</i> [9]
Current Measurement Sampling Frequency	Up to 2 Msamples/sec	Configurable via the <i>UCB</i>
Measured Current Range	±16.5 A <sub>peak</sub>	Configured by the shunt resistors and <i>NCS20166</i> output offset and gain
Overcurrent Protection	+21.5 A <sub>peak</sub> (rise time delay 500 ns)	Configured by the shunt resistors and the – <i>NCS2250SN2T3G</i> – comparator threshold
<b>DC-LINK VOLTAGE MEASURING</b>		
DC-Link Voltage Range	0 V – 483.7 V	
DC-Link Voltage Divider Gain	0.0068218	Configured by the voltage divider
DC-Link Voltage Resolution	0.236 V / bit	Based on MDK integrated 11 bits ADC
<b>INVERTER PHASE VOLTAGES MEASURING</b>		
Phase Voltages Range	0 V – 241.7 V	
Phase Voltages Divider Gain	0.0136495	Configured by the voltage divider
Phase Voltages Resolution	0.472 V / bit	Configured by <i>MDK_SPM31</i> integrated 11 bits ADC
<b>AUXILIARY POWER SUPPLIES MAXIMUM DEMAND</b>		
15 V	4.4 W	Generated by the <i>NCP1063</i>
5 V	2.9 W	Generated by the <i>FAN8303</i>
3.3 V	0.05 W	Generated by the <i>NCP718</i>
<b>CONTROL (Note 1)</b>		
UCB		Pluggable via two polarized Bergstak® 0.80 mm Pitch connectors
Type of Control (in Flash)		V/f / FOC
Supported Type of Motors		ACIM, PMSM, BLDC
<b>APPLICATION</b>		
White Goods (Washers), Industrial Fans, Industrial Automation		

1. It comes with a with a graphical user interface that is available through the link in [12]

BLOCK DIAGRAM

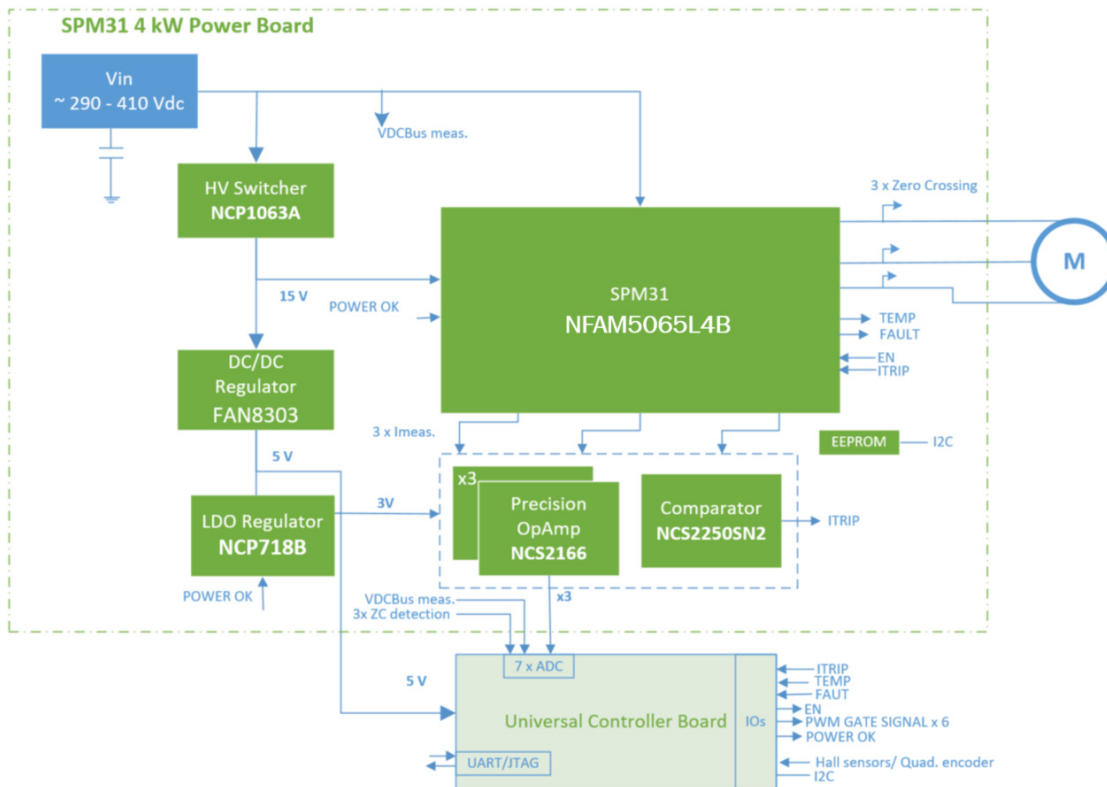

Figure 4. Block Diagram of the MDK\_SPM31 Board

Out of a variable Vdc input (200–400 Vdc), the board can deliver continuous power in excess of 1 kW or up to 4 kW for a short period to a three-phase motor. The foremost circuitries conforming the system are, the auxiliary power supplies, the current and voltage sensing, the overcurrent protection, and of course the three-phase inverter, build with the *NFAM5065L4B* IPM. Figure 4 illustrates the overall view of the above circuitries.

**Inverter Stage with Intelligent Power Module (IPM) Technology**

The inverter power stage is the backbone of this development board and it performs the DC/AC conversion. It utilizes the *NFAM5065L4B* IPM module, a fully integrated power stage for three-phase motor drives consisting of six IGBTs with reverse diodes, an independent high side gate driver, LVIC, and a temperature sensor (VTS). The IGBT's are configured in a three-phase bridge with separate emitter connections for the lower legs to allow the designer flexibility in choosing the current feedback topology and resolution. This module leverages the Insulated Metal Substrate (IMS) technology from ON Semiconductor. Packaged in the DIP39 format, the *NFAM5065L4B* (from here on *IPM*) not only provides a highly integrated, compact and rugged solution, but also best-in-class thermal management capabilities. In short, the module enables lower component count designs for industrial motor drives and

simplifies the development, reducing the time-to-market of new solutions.

Protection function in the system include under-voltage lockout, and external hardware shutdown for over-current protection via a comparator-based trigger event, which is currently configured at +21 A via the current sense and voltage-divider selection. By changing the voltage divider resistors, the designer can change the over-current protection threshold. Finally, external shutdown via software is also possible (via *CIN* pin), allowing the user to define a multilayer current protection function.

In this development board the DC-Link, which is provided by an external power supply, serves as the power input to the inverter module. The module needs to be supplied as well with 15 Vdc, necessary for the IGBT gate drivers, 5 Vdc necessary for the *MDK\_SPM31*, as well as with 3.3 Vdc voltage necessary for the current measurement Op-Amps and over-current protection comparators. The auxiliary power supplies that have been referred earlier (*NCP1063*, *FAN8303*, and *NCP718*) in the document provide these voltage rails.

*IPM\_FAULT* and *T\_MODULE* (temperature) are the output signals from the IPM module, which are routed to the *UCB* controller and can be used by the end-user for control and protection purposes. All operational input and output signals and the corresponding voltage references are

described in more detail in the [UCB Controller](#) section and in [Low-power Connectors](#), [High-power Connectors](#), and in Appendix. The applied design has been influenced by the [AND9390/D](#) [10] and the [NFAM5065L4B](#) [2] data sheet.

### Current Measurement

The development system is round out by the *NCS2250* High Speed Comparator, the *NCS20166* precision low-offset Op-Amp, and the *NCD98011* *UCB* integrated ADC module. Currently, ADC resolution is 11-bit resulting in an overall resolution of 0.016 A/bit, while the range of phase-current measurement is set to  $\pm 16.5$  A. The *NCS20166* gain selection, the current sense resistor selection, and the *NCD98011* ADC module that is integrated in *UCB* define the overall current resolution. The overall resolution and maximum current range can be found in Table 1. More details around the SAR concept and *NCD98011* can be found in [9].

### DC-Link and Inverter Phase-voltages Measurement

The DC-Link and inverter phase-voltage are both sensed via resistive voltage divider circuits, where the scaled-down voltage signals are used as inputs for the integrated *UCB* ADC – *NCD98011* – modules. As mentioned above, overall resolution and maximum voltage range can be found in Table 1.

### Over-current Protection and Under Voltage Protection Fault

The hardware over-current protection leverages the disable-option on the *IPM*. This function exploits the disable pin (*CIN* pin) of *IPM*, via the ITRIP signal that is provided to the power module by the *NCS2250* comparator. The disable-pin (*CIN* pin) is also controlled by *UCB* controller, allowing the end-user to configure a multilayer overcurrent protection. Finally, the end-user may also leverage the output fault signal of *IPM* (*VFO*), using the *UCB* controller. Note that *VFO* output is routed to *UCB*. As such, when a fault arises the software can use *VFO* output accordingly to shut down system operation or take other actions. Note that the above protection mechanism is implemented in software level, and as such it might be subjected to delays or spurious tripping if not properly handled.

### UCB Controller

The *UCB* is a powerful universal motor controller that is based on SOC Zynq 7000 series [11]. It includes a dual 667 MHz CPU Cortex A9 core, with freely configurable

digital peripheral, bootloader capability via micro SD card, USB/UART/JTAG interface, 32 Mbyte Flash memory, 32-Bit-wide 256 MByte DDR3 SDRAM, on-board Ethernet phy, 10 ADC channel – using ON Semiconductor *NCD98011*), and 12 complementary PWM channels. The *UCB* is an industrial-grade System on Module (SoM) that can be used for advanced networked motor and motion control systems, capable of delivering advanced control strategies for different types of motors (AC induction motor, PMSM, BLDC).

The *UCB* controller interacts with the power board via specific pins, which are routed to two – 120 pins each – connectors. More details around the connectors can be found in [Board Connectors](#). Auxiliary 5 Vdc and 3.3 Vdc power supplies can be used for powering-up the *UCB* board. They are located at the main power board. Alternatively, the *UCB* can be powered-up from the 5 Vdc USB cable, which is connected to the controller. Then, the *UCB* generates all the voltage rails (3.3 Vdc included) that are required for its proper operation. In addition, it also delivers (independently of the main auxiliary supplies) the necessary 5 Vdc and 3.3 Vdc reference voltages for the Op-Amps and comparators on the power board. Therefore, functionality of the controller, as well as the functionality of the Op-Amps and comparators can be evaluated even when the main power board auxiliary supplies are off.

Finally, the *UCB* provides the control capabilities of the system, and supports the user interface communication. End user can develop its own applications to exploit the *UCB* features and capabilities. As mentioned earlier the *MDK\_SPM31* power board provides all the required feedback to the *UCB* for the generation of PWM driving signals to control the IGBT module gate drivers as well as to enable/disable the module in the event of faults arising. This allows end-user to develop many different control strategies from simple V/F and Field Oriented Control (FOC) up to predictive control algorithms. Moreover, the *UCB* enables bidirectional serial communication to transfer measurements data for visualization purposes. A Graphical User Interface is provided, along with an appropriate code in flash that can run a simple V/F control or an FOC and allow visualization of key electrical quantities. More details around the software can be found in [Software](#) section. The interface header pinout of *MDK\_SPM31* is described in detail in [Board Connectors](#). A detailed description of the *UCB* connector can be found in Appendix. Finally, the documentation around *UCB* can be found in [1].



# SECO-MDK-4KW-65SPM31-GEVB

## FAN8303 and NCP718 Auxiliary Power Supplies

The *FAN8303* is a non-isolated buck that is used as converter from 15 Vdc to 5 Vdc output. The maximum power demand is 2.9 W. Figure 6 depicts the schematic of the 5 Vdc auxiliary power supply. Similarly to the *NCP1063*, the design and sizing of the passive components has been inspired by the applications notes in [4]. The desired output voltage value can be set by tuning the values of the voltage divider (*R5* and *R6*) connected to the FB pin.

Additionally, the value of *C17* on the *COMP* pin is tuned empirically to reflect the desired voltage at the converter output. The controller operates at fixed 370 kHz with an efficiency up to 90%. This allows a design with only 22  $\mu$ H magnetizing inductance (see *L3*) and two 22  $\mu$ F capacitors (see *C13* and *C14*). Finally, Figure 6 depicts the *NCP718* LDO, which is responsible for the 3.3 Vdc rail generation.

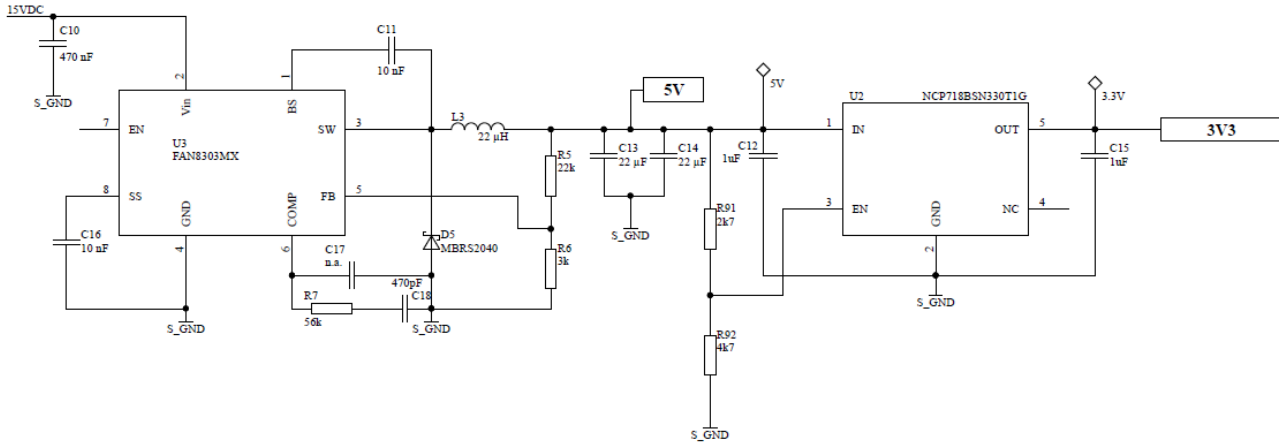

Figure 6. Schematic of Auxiliary 5 Vdc and 3.3 Vdc Power Supply

## Inverter Stage: Compact Intelligent Power Module (IPM) Technology

This subsection shows how the necessary circuitry for operation, measurement and protection is setup around the *NFAM5065LAB* IPM. In addition, it illustrates the necessary circuitry to provide and capture the signals around the module (i.e. the output signals: *T\_MODULE*, *IPM\_FAULT*; and the input signals: *ITRIP*, *IPM\_DIS*, and gate driver signals *INH\_U*, *INH\_V*, *INH\_W*, *INL\_U*, *INL\_V*, *INL\_W*). Finally, it illustrates the provision of the voltage rails for the IPM (15 Vdc rail reference), as well as the measurement of the DC-Link and inverter-phase voltages. Activation of IPM stage (connection to 15 Vdc power supply) is via J1 (soldered pads). Figure 7 shows the *J1* pads at the bottom side of the board; mind that pads should be soldered together to enable the 15 Vdc to the IPM. Following, Figure 8 shows

the schematic of the inverter stage and the necessary circuitry around it. Finally, Figure 8 depicts the DC-Link voltage (voltage divider containing *R46*, *R52*, *R53* and *R55*) and the inverter output phase-voltage measurement circuitry (voltage divider for phase-U containing *R31*, *R34*, *R40* and *R42*; voltage divider for phase-V containing *R32*, *R35*, *R41* and *R43*; and voltage divider for phase-W containing *R29*, *R33*, *R39* and *R44*). The inverter output voltage phases can be used by the software for zero crossing detection or other control purposes. The signals from the 10 m $\Omega$  shunt resistors are going to current measurement and over-current protection circuits. Details regarding the ADC resolution of the above sensed electrical quantities can be found in Table 1. Next paragraphs are dedicated to the elaboration of the above mentioned circuitries.

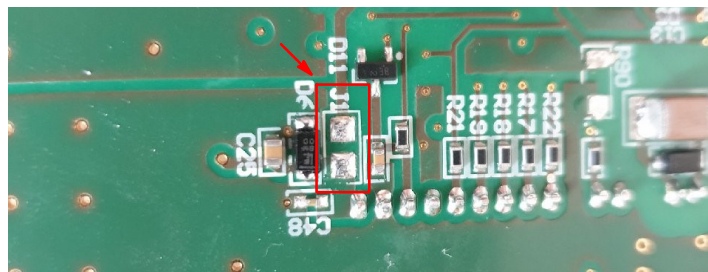

Figure 7. J1 Pads at the Bottom of the Board (the Pads should be Soldered to Enable the 15 Vdc in the IPM)



# SECO-MDK-4KW-65SPM31-GEVB

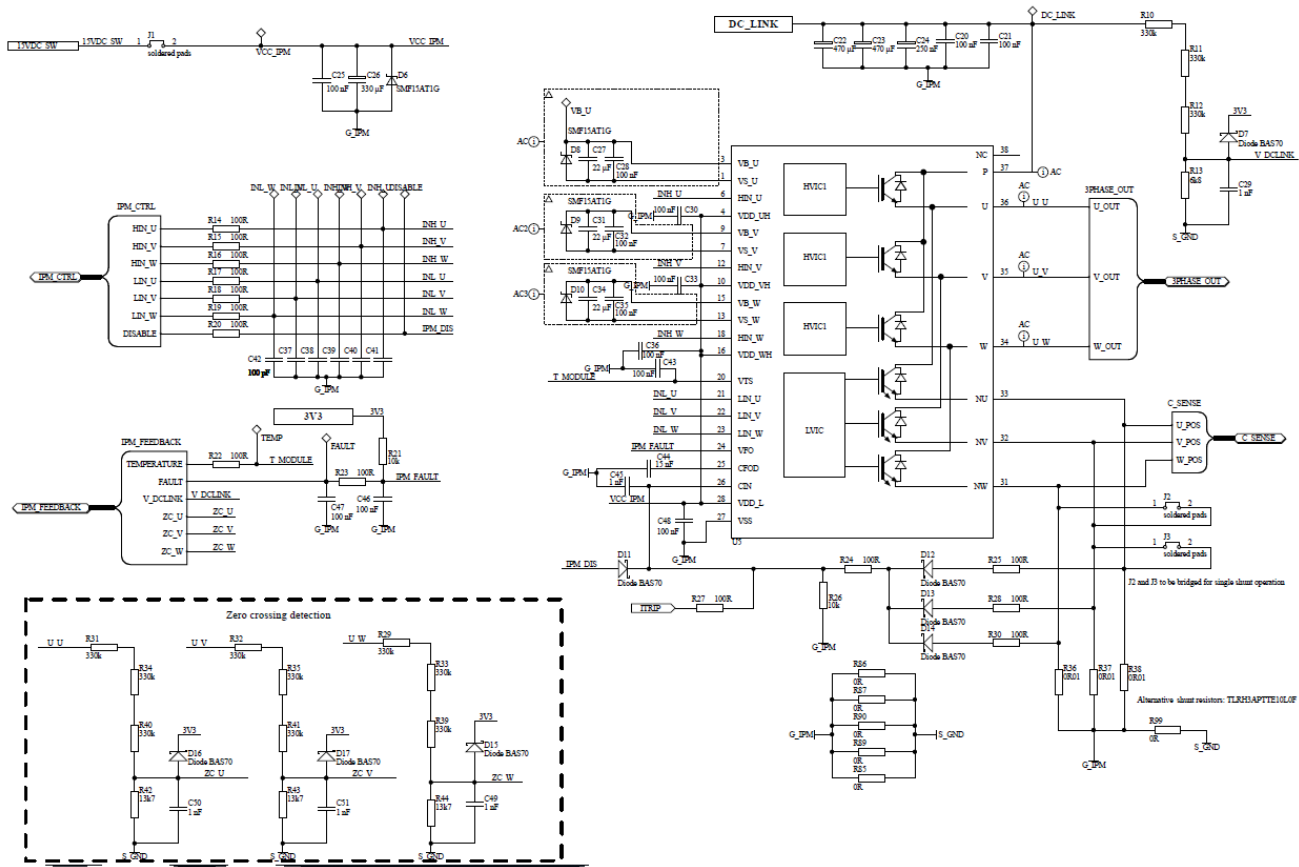

Figure 8. Schematic of – IPM – Inverter Stage

Considering that the reference voltage for the ADC *NCD98011* modules is 3.3 Vdc, the resistors of the DC-Link voltage measurement were designed according to the following voltage divider formula, where  $V_{ADC}$  is the voltage arriving at *NCD98011*:

$$V_{ADC} = V_{DC-Link} \cdot R_{13} \cdot (R_{10} + R_{11} + R_{12} + R_{13}) \leq 3.3 \text{ V}$$

To minimize the current flowing through the voltage divider and also power losses, the values of resistors should be chosen in hundreds kΩ. With the chosen values of resistors, the maximal possible measured  $V_{DC-Link}$  can be:

$$V_{DC-Link,max} = 3.3 \cdot \frac{(R_{10} + R_{11} + R_{12} + R_{13})}{R_{13}} = 483.7 \text{ V}$$

As the DC-Link maximum allowed value is 410 V, we have around 15% margin.

As discussed earlier, the effective resolution of the ADC *NCD98011* is 11-bit, which results in a total resolution of:

$$V_{DC-Link,res} = \frac{483.7}{2^{11}} = 0.236 \text{ V}$$

On the other hand, the maximum possible measured voltage for the inverter output phases can be:

$$V_{U,V,W,max} = 3.3 \cdot \frac{(R_{31,32,29} + R_{34,35,33} + R_{40,41,39} + R_{42,43,44})}{R_{42,43,44}}$$

$$= 241.7 \text{ V,}$$

which results to a resolution of:

$$V_{U,V,W-Link,res} = \frac{241.7}{2^{11}} = 0.472 \text{ V}$$

Please note that the inverter phase voltage measurement with the currently used resistors will be saturated for DC-Links higher than 241.7 V, as demonstrated in the figures below. However, this configuration allows detection of the zero crossing BEMF with increased accuracy, as you can compare the inverter output phase with the half of the DC-Link voltage. It should be noted that with the currently used resistor network, the inverter output phase-voltage could be used only to detect the BEMF zero crossing for trapezoidal-type controls with respect to the half of the DC-Link voltage. For different zero-crossing detection methods, such as the reconstruction of inverter neutral voltage in software, or for different control algorithms where the full range of inverter phase voltages is required, you should replace the three bottom 13.7 kΩ resistors *R42*, *R43*, *R44* with 6.8 kΩ ones. The main reason of using this limited voltage range for the inverter output phase is to increase the voltage resolution around the BEMF zero crossing, where only two out of three inverter phases are energized.

# SECO-MDK-4KW-65SPM31-GEVB

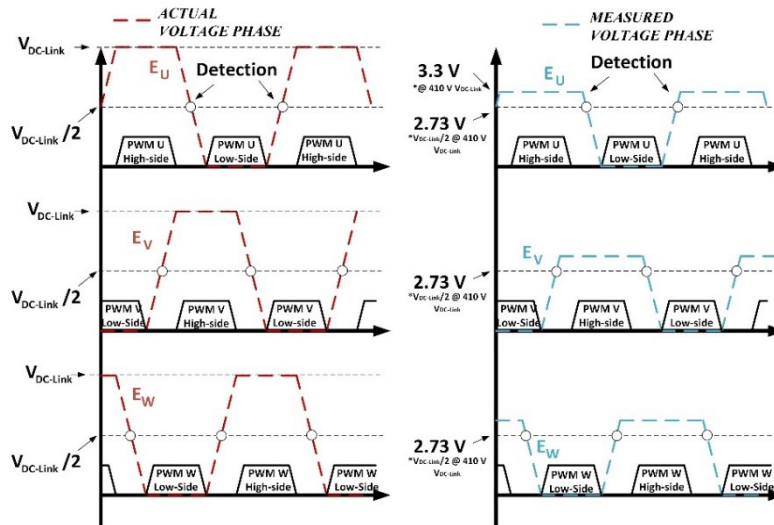

Figure 9. Actual and Measured Voltage Phase with Currently used Voltage Divider



Figure 10. UCB UART Disable via Soldering R70 at MDK Board

## On Board (UCB) UART

The UART module that is integrated at *UCB* can be disabled by soldering R70. To allow UART communication at *UCB* you should keep R70 empty, as in Figure 10.

## Current Measurement and Over-Current Protection

The maximum current that can be measured with the existing circuitry can be calculated as:

$$I_{\max+} = \frac{V_{ADC,\max} - V_{\text{offset}}}{G \cdot R_{\text{shunt}}} = 16.5 \text{ A}$$

$$I_{\max-} = \frac{-(V_{\text{offset}})}{G \cdot R_{\text{shunt}}} = -16.5 \text{ A},$$

where  $V_{ADC,\max}$  is the maximum voltage at *NCD98011* ADC modules (i.e. 3.3 V as mentioned earlier),  $V_{\text{offset}}$  is the external offset for the Op-Amps (i.e. 1.65 V),  $G$  is the Op-Amps gain (i.e. 10), and  $R_{\text{shunt}}$  is the value of the shunt resistors (i.e. 0.01  $\Omega$ ). The total resolution considering also the *NCD98011* ADC modules is:

$$I_{\text{res}} = \frac{16.5 \cdot 2}{2^{11}} = 0.016 \text{ A}$$

Considering the layout design, a good practice consists of using kelvin sensing and place the op amp as close as possible to the shunt resistors as illustrated in Figure 11.



## SECO-MDK-4KW-65SPM31-GEVB

IPM can be shut-down by setting the voltage level of the *CIN* pin to 0.5 V or higher. The NCS2250 comparator is responsible for asserting the *CIN* pin high, protecting the board against an overcurrent incident (the output of the overcurrent comparator drives *ITRIP* signal, which is routed to *CIN*, Figure 8). *CIN* pin is also controlled by the *UCB* controller, which allows the end-user to design multilayer protection. Comparator threshold is set by a voltage divider, which consists of the *R65* and *R69* resistors. That threshold is compared against the non-inverting pin voltage, which comes from the voltage across the shunt resistors *R60*, *R64* and *R66*. The comparator also incorporates a hysteresis loop by providing a feedback to the non-inverting pin via the *R63* resistor. Based on the above selected resistors the tripping threshold corresponds to +21 A. To prevent spurious operation of comparator, a low pass filter is implemented, formed by the capacitor *C68* along with resistors *R60*, *R64*, and *R65*. The cut-off frequency of the formed low-pass filter results in a delay of around 500 ns, which is sufficient for the fast reaction of the current protection.

On top of that, IPM asserts fault pin (*VFO*), which can be used by the *UCB* to shut down the inverter. The voltage level of that pin is low during normal state. After a fault occurrence at the driver, the output of fault pin is switched high. The output of fault pin is held on for a time determined by the *C44* capacitor (15 nF) that is connected to the *CFOD* pin (*IPM* pin 25), which can be used by the software for further actions. The equation that gives the on time of the pulse ( $ton_{fault}$ ) is:

$$ton_{fault} = 0.1 \cdot 10^6 \cdot C44 = 1500 \mu s$$

### Board Connectors

*MDK\_SPM31* comes with several connectors that allow the board to interact with external systems, such as encoders and different control platforms (i.e. *UCB*). *MDK\_SPM31* also carries the appropriate connectors to host the *UCB*

controller. The interconnections/routing of the signals that are associated with the connectors of the *MDK\_SPM31*, as well as the power-connectors of the board are described later in this subsection.

### Low-power Connectors

The *MDK\_SPM31* board has seven connectors in total. Five of those connectors (CON7, CON6, J4, and CON4 and CON5,) interfere with the various low-power signal and voltage rails, while the rest two connectors handle the high dc-input and the three-phase ac-output high power voltages.

Figures 13–15 depict the low power connectors schematics of the board along with their physical visualization.

CON7 (Figure 13) can be used as an interface between the encoder and the *UCB* controller, enabling sensed-FOC control algorithms.

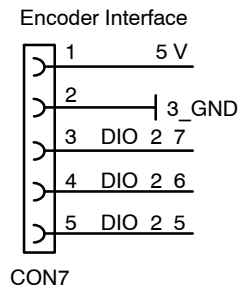

**Figure 13. Schematic and Physical Visualization of Encoder Interface**

The connector CON6 gives access to additional digital I/O, PWM, and ADC pins of the *UCB* controller. Low pass filters for current and/or voltage measurement signals are placed closed to the headers (see Figure 14).

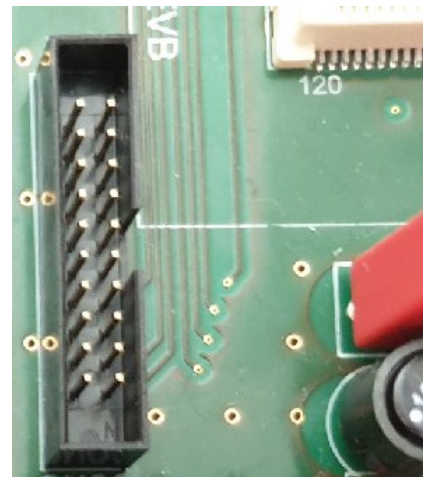
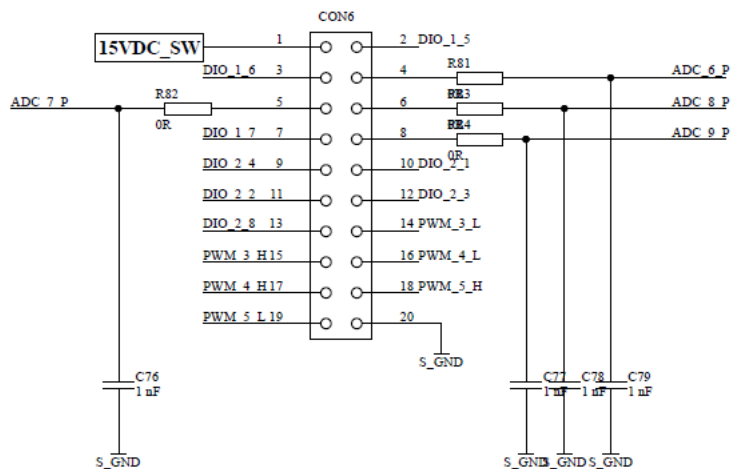

**Figure 14. Schematic and Physical Visualization of CON6**



# SECO-MDK-4KW-65SPM31-GEVB

## Additional Connections to the UCB Controller

Finally, Figure 18 depicts some additional connections from MDK\_SPM31 to the UCB controller.

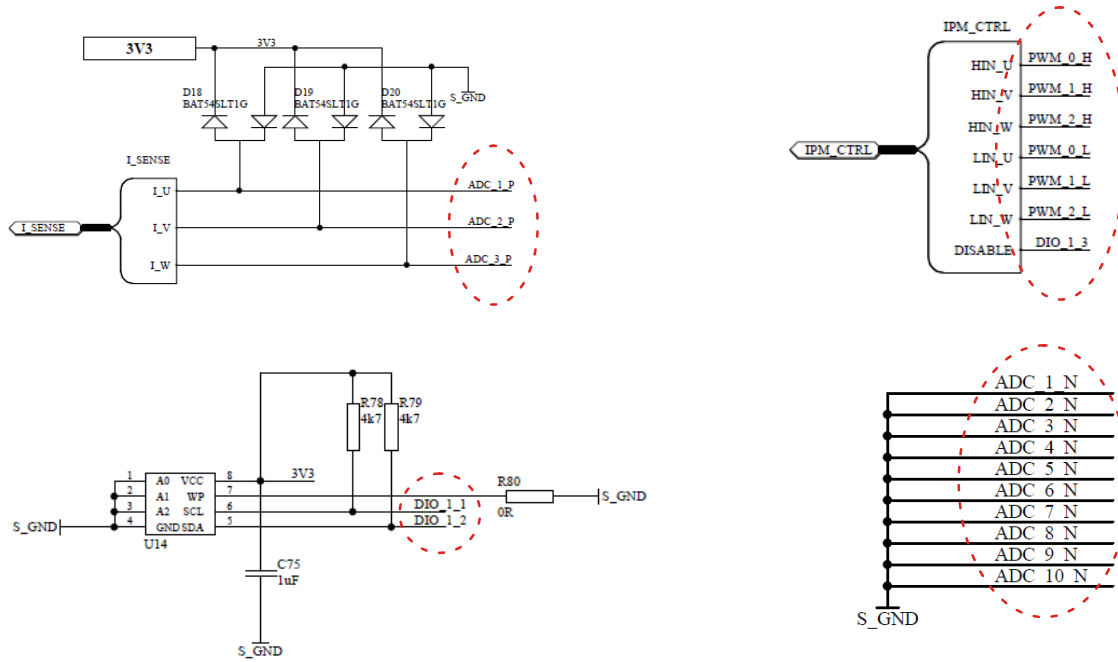

Figure 18. Connections to the UCB

## SOFTWARE

FOC has been widely used during the last decade as an efficient way to control various types of motors over wide speed ranges. The controller optimizes the efficiency of the system as it produces the required motor torque with the lowest possible phase-currents, by maintaining a 90o angle between the rotor flux and current. Moreover, it provides fast dynamic response and a low current harmonic content. Numerous scientific and technical papers in literature describe thoroughly the FOC operation. We would like to note that the analysis of FOC falls beyond the scope of this document. For a more comprehensive description of FOC operation, the reader may refer to the corresponding references. [13–15].

### UCB with Pre-flashed Firmware

(UCB acquired as part of SECO-MDK-4KW-65SPM31-GEVK)

If you acquired the UCB as part of the ON Semiconductor kit, the controller is already flashed with V/F control and FOC control. The user does not have to perform any further actions for booting. It is noted however, that booting from the flash, the SD-socket at UCB should be empty. With the flashed controller, the user can control the motor via the graphical user interface (GUI) of Figure 19; to download the GUI, click the link in [12], download the latest version of software, open the MDK\_GUI zip file, and run the

executable *Serial\_Gui* file. With the GUI, the user can select between the V/F and FOC strategy. The GUI also assists the end-user to configure and tune the foremost V/F and FOC parameters, while it also provides visual representation of key electrical variables, such as the DC-Link voltage and temperature of IPM, the RMS value of the inverter output current and voltage, and the motor speed.

### Rewriting Flash Memory or SD-card Image

(Important when UCB not acquired as part of the SECO-MDK-4KW-65SPM31-GEVK)

In case the user wants to rewrite the flash memory with the default V/F-FOC control, he can use the *boot-image* and *fsbl.elf* files that are accessible via the link in [12]. To download the *boot-image* and *fsbl.elf*, click the link in [12] and download the latest version of software; *boot-image* and *fsbl.elf* files are included in the *UCB\_firmware* of the downloaded software file.

The following guide contains material on how to load the boot image:

- Flashing QSPI memory [16] ([link](#)).

To boot from SD card, copy the boot image that is found in [12] into the root directory of the SD card. Then place the SD card into the SD socket of UCB. Upon power-up the UCB will automatically boot from the SD card.

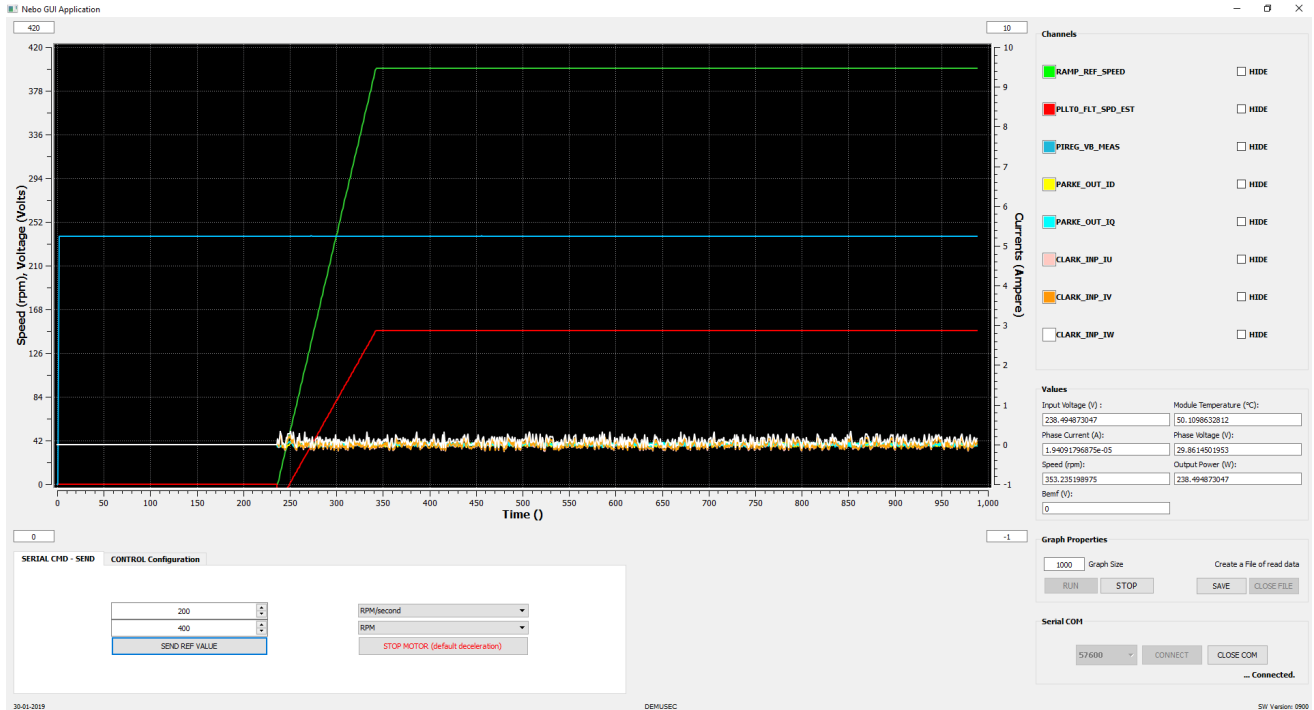

Figure 19. Graphical User Interface (GUI)

# SECO-MDK-4KW-65SPM31-GEVB

## TESTING AND OPERATION

This section describes how to test and operate the development board and present the test results. At the beginning the *Safety and Precautions are described, which are a mandatory read before manipulating the board.*

### Safety Precautions

This section describes the Safety Precautions which are a mandatory read before manipulating the board.



#### Attention:

The SECO-MDK-4KW-65SPM31-GEVB is powered by external DC power supply, and is exposed to high voltage. Only trained personnel should manipulate and operate on the system. Ensure that all boards are properly connected before powering, and that power is off before disconnecting any boards. It is mandatory to read the Safety Precautions Table before manipulating the board. Failure to comply with the described safety precautions may result in personal injury or death, or equipment damage.

**Table 2. SAFETY PRECAUTIONS**

1	<b>Ground Potential</b>	The ground potential of the system is biased to a negative DC bus voltage potential. <i>When measuring voltage waveform by oscilloscope, the scope's ground needs to be isolated.</i> Failure to do so may result in personal injury or death.
2	<b>USB Isolation</b>	The ground potential of the system is NOT biased to an earth (PE) potential. When connecting the MCU board via USB to the computer, <i>the appropriate galvanic isolated USB isolator have to be used. The recommended isolation voltage of USB isolator is 5 kV.</i>
3	<b>DC BUS Capacitors</b>	<i>SECO-MDK-4KW-65SPM31-GEVB system contains DC bus capacitors which take time to discharge after removal of the main supply. Before working on the drive system, wait ten minutes for DC BUS capacitors to discharge to safe voltage levels. Failure to do so may result in personal injury or death.</i>
4	<b>Trained Personnel</b>	<i>Only personnel familiar with the drive and associated machinery should plan or implement the installation, start-up and subsequent maintenance of the system.</i> Failure to comply may result in personal injury and/or equipment damage.
5	<b>Hot Temperature</b>	<i>The surfaces of the NFAM5065L4B and development board drive may become hot, which may cause injury.</i>
6	<b>ESD</b>	<i>SECO-MDK-4KW-65SPM31-GEVB system contains parts and assemblies sensitive to Electrostatic Discharge (ESD). Electrostatic control precautions are required when installing, testing, servicing or repairing this assembly.</i> Component damage may result if ESD control procedures are not followed. <i>If you are not familiar with electrostatic control procedures, refer to applicable ESD protection handbooks and guidelines.</i>
7	<b>Installation and Use</b>	<i>A drive, incorrectly applied or installed, can result in component damage or reduction in product lifetime.</i> Wiring or application errors such as under sizing the motor, supplying an incorrect or inadequate AC supply or excessive ambient temperatures may result in system malfunction.
8	<b>Powering Down the System</b>	<i>Remove and lock out power from the drive before you disconnect or reconnect wires or perform service. Wait ten minutes after removing power to discharge the DC bus capacitors.</i> Do not attempt to service the drive until the bus capacitors have discharged to zero. Failure to do so may result in personal injury or death.



# SECO-MDK-4KW-65SPM31-GEVB

## Test Procedure

This section presents the test procedure and results for the evaluation of the platform. The aim of these tests is to show the system level performance of the *IPM* as well as the performance of some of the key subsystems. The described and presented test and results include:

- Load tests
  - ◆ 1 kW
  - ◆ 4 kW
- Auxiliary power supply
  - ◆ Load transient

## Setup and Start-up Procedure

Figure 20 shows an overview of the test setup. The test-bench consists of five main parts:

1. DC-power supply
2. *MDK\_SPM31* power-board
3. R-L load/or MOTOR
4. PC/Laptop with a USB-C cable connection to a serial com port for the graphical user interface
5. Oscilloscope to monitor the inverter output currents and voltage.

Ensure to follow and implement the Safety precautions described in [Safety Precautions](#) while testing and manipulating the board.

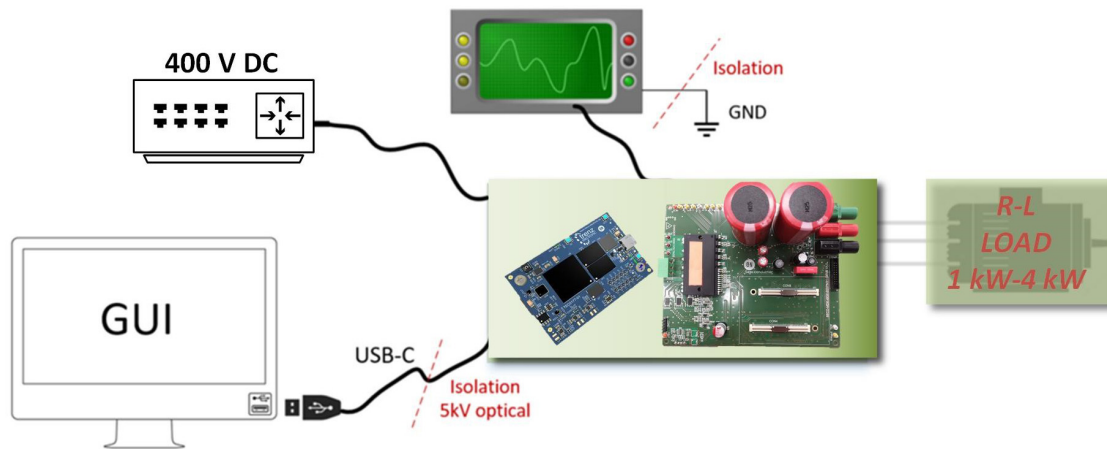

Figure 20. Overview of Schematic Set-up

The procedure to start-up and power down the development board is described below. Please read the mandatory Safety precautions detailed in [Safety Precautions](#) before manipulating the board.

1. Connect the DC-power supply cables to the *MDK\_SPM31* board. Connect the positive voltage to the red connector of *MDK\_SPM31*, while the negative to the black. Connect the green connector to the earth.
2. Set a maximum voltage and current limit at the power supply. Use 410 V and 13 A
3. Connect your laptop to the UCB via the USB-C cable
4. Run the executable file of the GUI that is found in [12]
5. On the pop-window press the “Connect” to connect to the UCB board
6. If the connection is successful, an indication “Connected” will appear at the bottom right of GUI. If connection fail several times, reconnect the USB-C cable and try again
7. After being connected, you can change the following configuration in the GUI: You can select one of the two available control strategies (i.e. FOC or V/F); the maximum motor phase voltage and speed; the

- pole-pairs of the motor; and finally you can select the gains of the PI controllers (used only in FOC). If one or more of above the parameters is not configured, the software will use the default value. Default values are: control strategy is V/F, maximum voltage 200 Vrms, maximum speed 9000 RPM, 4 pole-pairs, gains of current regulator 30 and 2500, gains of speed regulator 0.08 and 0.05.
8. After having configured the control and motor parameters, push the “RUN” button (the motor will not start yet)
9. Switch on the power supply at 400 V, and observe the voltage at the GUI
10. Set a target speed and a target acceleration and press the “SEND REF VALUE” button
11. The motor should start running
12. To stop the motor press the “STOP MOTOR” button
13. When the test stops and the DC source is disconnected from the *MDK\_SPM31* board, there might be still voltage on the DC link capacitor, so *please be careful*.



## SECO-MDK-4KW-65SPM31-GEVB

### Test Results

This section presents the results of the experimental test performed on the board. For the experimental test we have used an R-L load which is rated up to 4 kW, instead of a motor. The IPM switching frequency is set to 16 kHz, while the dead-time of the IPM is set 1500 ns. Finally, the DC-Link is set to 400 V, via a DC-power supply. The equivalent R-L emulates the motor and consists of three inductors (5 mH per phase) connected in series with a resistive bank that comprises variable resistors from 7.55 Ω up to 30 Ω per each phase. The above configuration forms an equivalent three-phase R-L load in Y connection,

which emulates a three phase motor. Figure 21 illustrates the electrical equivalent of the R-L load along with the electrical quantities under measured. The experimental results and captured waveform are depicted in Figures 22–27, showing the captured current and voltage waveforms, along with the reading from the DC-power supply. Thermal analysis results from FLIR A645SC camera conclude the section.

Table 3 summarizes the electrical parameters that have been used for the test, as well as the values of the electrical quantities that we have measured. The recorded efficiency was 95% and 96% respectively.

**Table 3. SYSTEM PARAMETERS – RECAP TABLE**

Test	V <sub>dc</sub> (V)	Switching Frequency (kHz)	Resistance per phase (Ω)	Inductance per phase (mH)	PF	RMS Current (A)	Phase Volt Target (V <sub>RMS</sub> )	Phase Volt Meas. (V <sub>RMS</sub> )	DC Supply (W)	Temp (°C)	η %
1 kW	400	16	10.5	5	0.99	5.694	67.17	60.46	1091	65.8 (25 min)	95%
4 kW	400	16	10.5	5	0.99	11.1	127.3	120.35	4168	83.1 (8 min)	96.2%

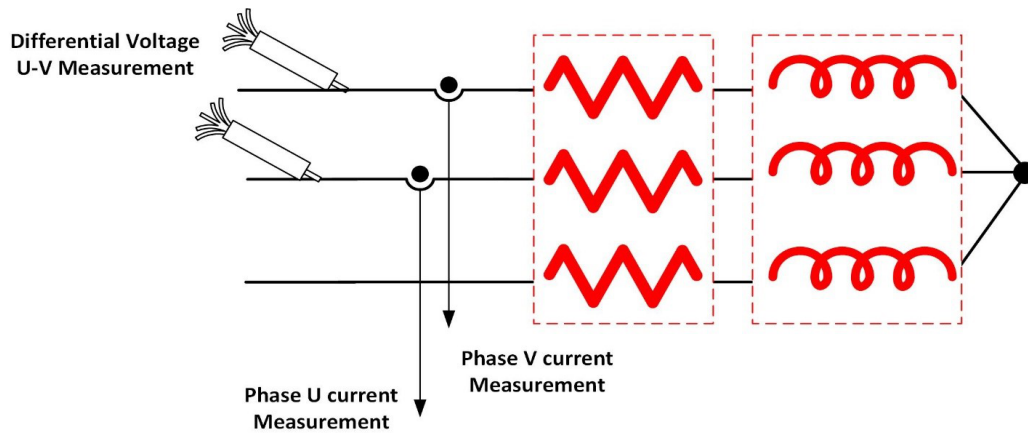

**Figure 21. Electrical Schematic of R-L Load/Representation of the Measurement Points**

# SECO-MDK-4KW-65SPM31-GEVB

1 kW Test

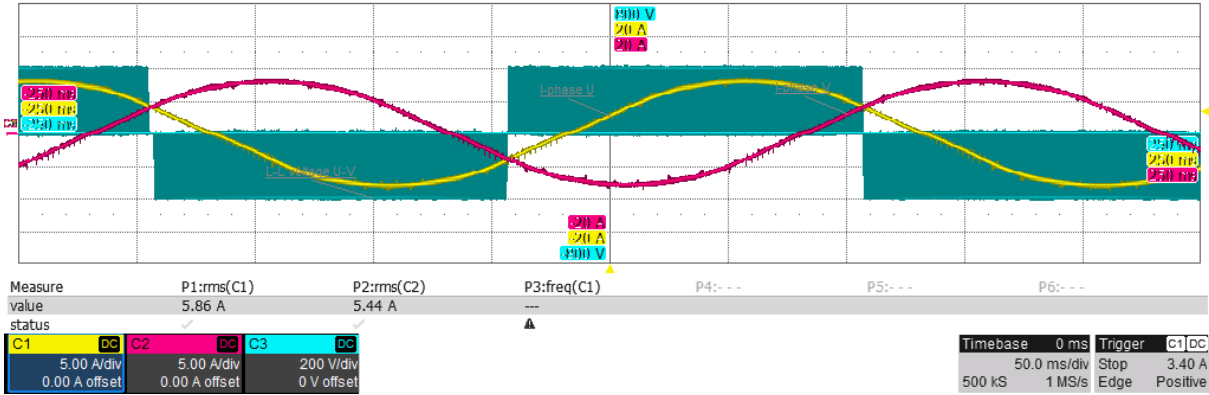

Figure 22. Phase Current U, Phase Current V, Inverter Output L-L voltage (UV) @ 1 kW



Figure 23. DC Power Supply Reading @ 1 kW.

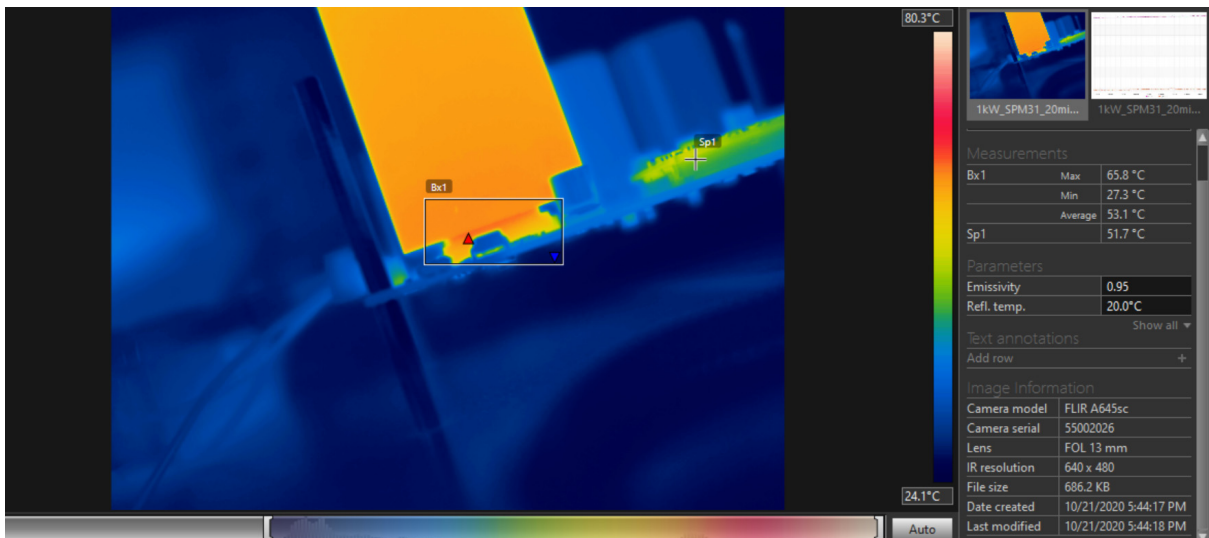

Figure 24. Thermal Camera Capture @ 1 kW after 25 Minutes of Operation

# SECO-MDK-4KW-65SPM31-GEVB

4 kW Test

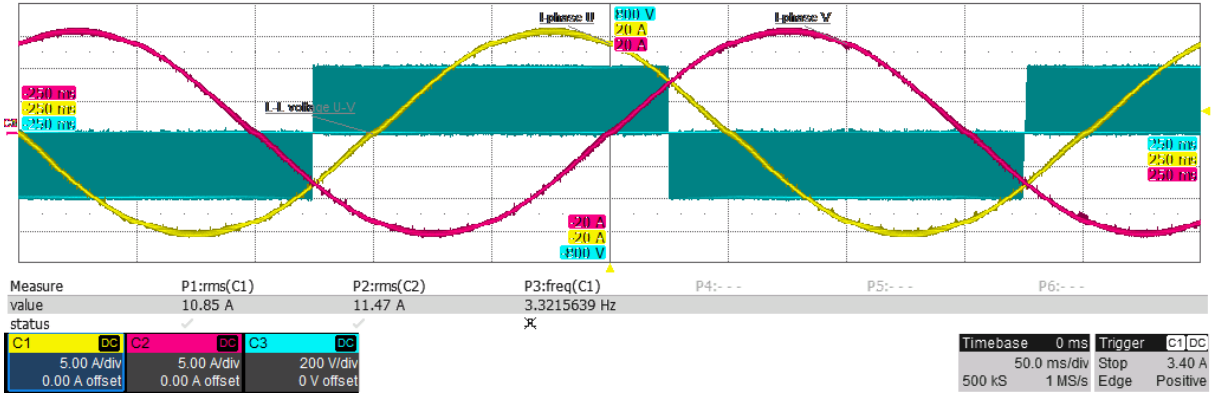

Figure 25. Phase Current U, Phase Current V, Inverter Output L-L Voltage (UV) @ 4 kW

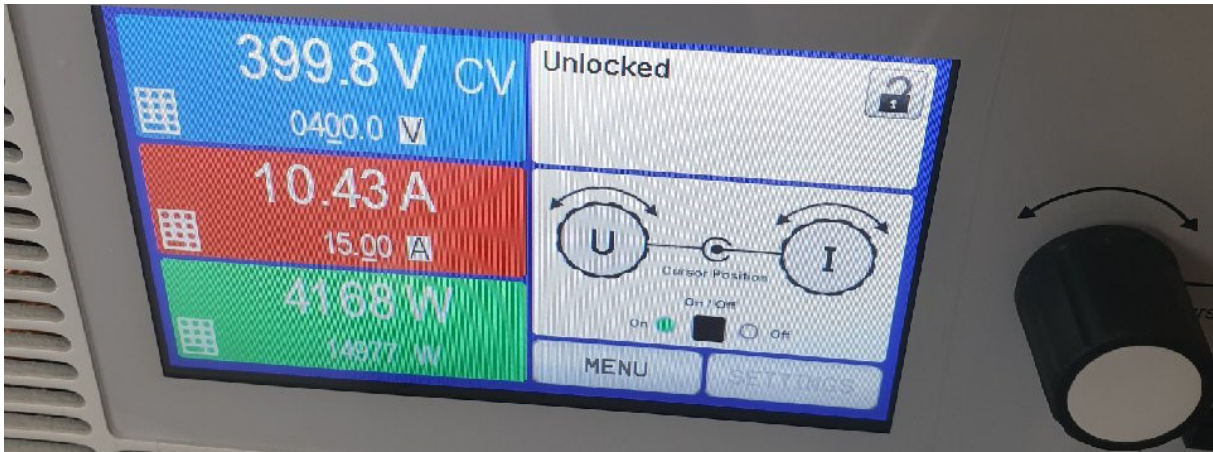

Figure 26. DC Power Supply Reading @ 4 kW

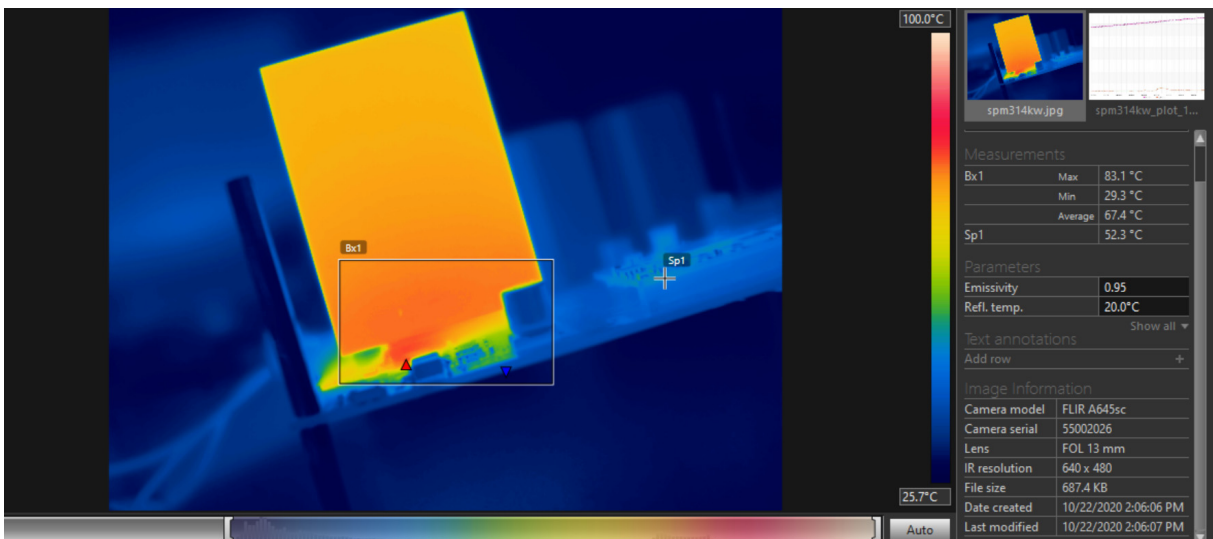

Figure 27. Thermal Camera Capture @ 4 kW after 8 Minutes of Operation

# SECO-MDK-4KW-65SPM31-GEVB

## Auxiliary Power Supply

Figure 28 shows the response dynamics of the output voltage at a constant input of 390 Vdc and for different loads.

The output of the power supply is set at 15 Vdc and its max deliverable power is 4.6 W.

Measure 1: 50 mA, Measure 2: Open Circuit, Measure 3: 300 mA

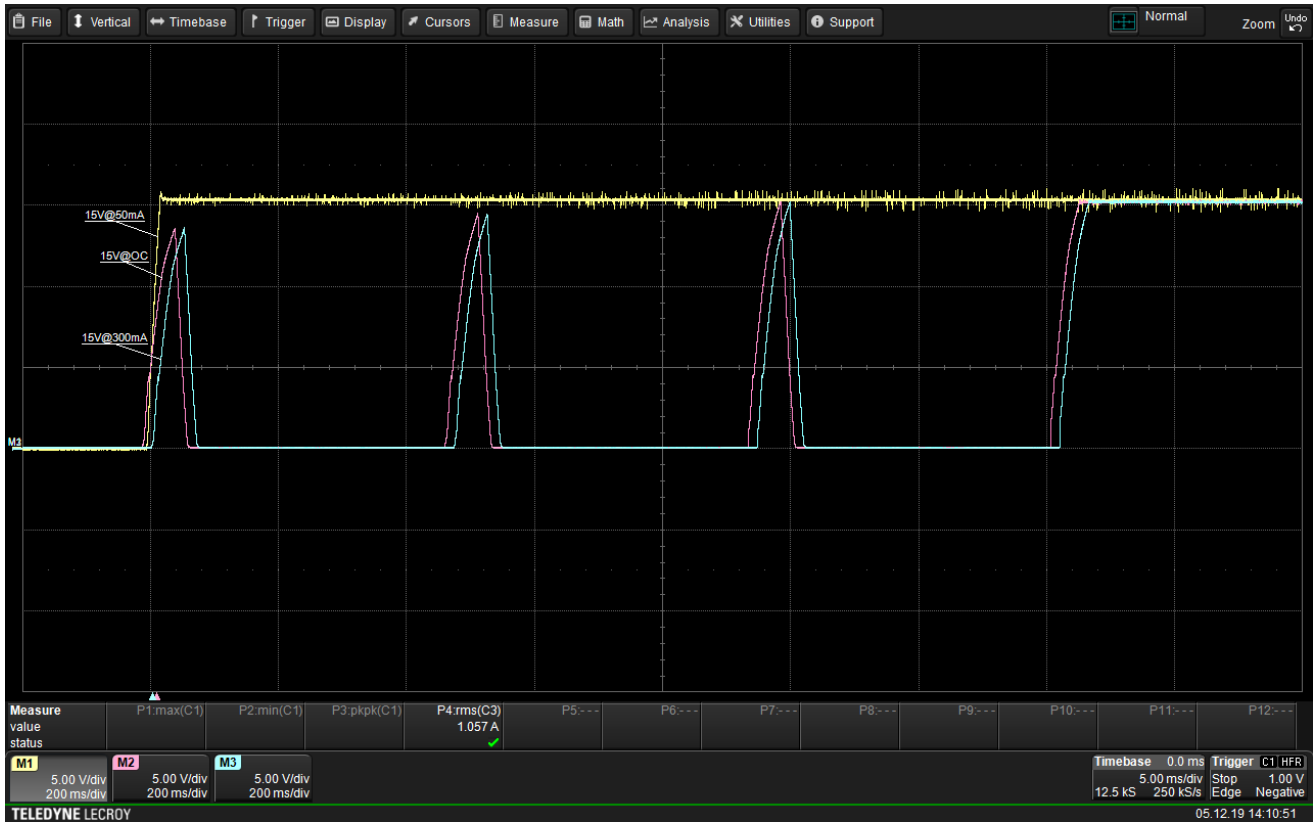

Figure 28. Start Up to Open Circuit, to 50 mA and to 300 mA at 390 V DC Input

# SECO-MDK-4KW-65SPM31-GEVB

## DEVELOPMENT RESOURCES AND TOOLS

Collateral, development files and other development resources listed below are available at *SECO-MDK-4KW-MCTRL-GEVB*. Table 4 presents bill of materials (BOM) of the board. Figures 29–32 illustrate the corresponding Altium output layers of the board.

- Schematics
  - BOM (below as well)
  - Manufacturing files
  - PCB layout recommendations and files (below as well)
- Evaluation board consist of 4.0 layers. Following figures

are showing all the layers. Board size is 160 x 130 mm. Layout recommendations in [AND9390/D](#) have been applied as well. Specifics about the current measurement layout are detailed in [Current Measurement and Over-Current Protection](#)

- Executable GUI
- Boot-image for booting from flash or SD card (on delivery UCB is already flashed)

### Bill of Materials

**Table 4. BILL OF MATERIALS**

Designator	Quantity	Value/Description	Manufacturer	Supplier Part Number
3.3 V, 5 V, 15 V	3	15 Vdc	Keystone Electronics	36-5008-ND
AUX_SW, DC_LINK, FAULT, TEMP, VCC_IPM	5	PTH testpoint eyelet	Keystone Electronics	36-5007-ND
C1	1	100 nF	Würth Elektronik	732-7989-2-ND
C2	1	10 µF	Würth Elektronik	732-8503-1-ND
C3	1	330 nF	Würth Elektronik	732-7676-1-ND
C4	1	100 nF	Würth Elektronik	732-5748-ND
C5	1	10 µF	Rubycon	1831326
C6	1	47 nF	Würth Elektronik	732-8011-1-ND
C7, C8	2	220 µF	Würth Elektronik	732-9171-1-ND
C9	1	150 nF	Murata	81-GRM188R71H154KA4D
C10	1	470 nF	Murata	490-11994-1-ND
C11, C16, C52, C56, C60	5	10 nF	Würth Elektronik	732-8007-1-ND
C12, C15, C75	3	1 F	AVX	1658870
C13, C14	2	22 µF	Würth Elektronik	732-7709-1-ND
C17, C18	2	n.a., 470 pF	Würth Elektronik	2495139
C19	1	1 nF	Murata	490-11503-1-ND
C20, C21	2	100 nF	Würth Elektronik	732-7411-1-ND
C22, C23	2	470 µF	Würth Elektronik	732-6678-ND
C25	1	100 nF	Würth Elektronik	732-8061-1-ND
C26	1	330 µF	Würth Elektronik	875075661010
C27, C31, C34	3	22 µF	TDK	1843167
C28, C30, C32, C33, C35, C36, C43, C46, C47, C48, C66, C67	12	100 nF	Würth Elektronik	732-7495-1-ND
C29, C45, C49, C50, C51, C68	6	1 nF	Würth Elektronik	732-8001-1-ND
C37, C38, C39, C40, C41, C42, C55, C59, C63, C65	10	100 pF	Würth Elektronik	732-7799-1-ND
C44	1	15 nF	Würth Elektronik	2534047

## SECO-MDK-4KW-65SPM31-GEVB

**Table 4. BILL OF MATERIALS** (continued)

Designator	Quantity	Value/Description	Manufacturer	Supplier Part Number
C53, C57, C61	3	100 nF	Würth Electronics	732-7965-1-ND
C54, C58, C62, C76, C77, C78, C79	7	1 nF	Würth Elektronik	732-7786-1-ND
C64	1	47 $\mu$ F	Murata	490-13247-1-ND
CON1	1	Banana Connector (positive output)	CLIFF Electronic Components	1854508
CON2	1	Banana Connector (negative output)	CLIFF Electronic Components	1854507
CON3	1	Pluggable Terminal Blocks (inverter output)	Würth Elektronik	691313710003
CON5	1	UCB Controller		
CON6	1	MALE BOX HEADER	Würth Elektronik	62502021621
CON7	1	PTH vertical male header	Würth Elektronik	732-5318-ND
CON8	1	Banana Connector (earth output)	CLIFF Electronic Components	419668
D1	1	MRA4007T3G	ON Semiconductor	1459137
D2	1	MMSD4148T1G	ON Semiconductor	MMSD4148T1GOSCT-ND
D3, D4	2	MURA160T3G	ON Semiconductor	1459149
D5	1	MBRS2040	ON Semiconductor	MBRS2040
D6, D8, D9, D10	4	SMF15AT1G	ON Semiconductor	2630276
D7, D11, D15, D16, D17	5	Diode BAS70		
D18, D19, D20	3	BAT54SLT1G	ON Semiconductor	BAT54SLT1GOSCT-ND
DISABLE, INH_U, INH_V, INH_W, INL_U, INL_V, INL_W	7	PTH testpoint eyelet	Keystone Electronics	36-5009-ND
G_IPM	1	PTH testpoint eyelet	Keystone Electronics	36-5124-ND
HSC1	1	Heatsink SK64550SA	Fischer Elektronik	SK645/50/SA
L1	1	1 mH	Würth Elektronik	2211747
L2	1	560 H	Würth Elektronik	7447452561
L3	1	22 $\mu$ H	Würth Elektronik	710-7447714220
R1, R7, R63, R65	4	56 k $\Omega$	Panasonic	P56.0KHCT-ND
R2, R3, R4	3	15 k $\Omega$	Panasonic	P15.0KHCT-ND
R5	1	22 k $\Omega$	Panasonic	P22.0KHCT-ND
R6, R68	2	3 k $\Omega$	Panasonic	2059357
R8	1	56.2 k $\Omega$	Panasonic	2326904
R9	1	1 k $\Omega$	Panasonic	2303145
R10, R11, R12, R29, R31, R32, R33, R34, R35, R39, R40, R41	12	330 k $\Omega$	Vishay	1470007
R13	1	6.8 k $\Omega$	Panasonic	667-ERJ-P08F6801V
R14, R15, R16, R17, R18, R19, R20, R22, R23, R27, R60, R64, R66	13	100 $\Omega$	Panasonic	2303059
R21	1	10 k $\Omega$	Panasonic	P10.0KHCT-ND

## SECO-MDK-4KW-65SPM31-GEVB

**Table 4. BILL OF MATERIALS** (continued)

Designator	Quantity	Value/Description	Manufacturer	Supplier Part Number
R36, R37, R38	3	0.01 $\Omega$	KOA SPEER ELECTRONICS	660-TLRH3APTTE10L0F
R42, R43, R44	3	13.7 k $\Omega$	Panasonic	P13.7KCCT-ND
R45, R49, R50, R54, R55, R61	6	10 k $\Omega$	YAGEO	9238603
R46, R48, R51, R53, R56, R59	6	1 k $\Omega$	Panasonic	2379938
R47, R52, R57	3	1 k $\Omega$	Panasonic	2303145
R58	1	680 $\Omega$	Panasonic	2303131
R62	1	1 k $\Omega$	Panasonic	2303145
R67	1	330 $\Omega$	Panasonic	2303104
R69	1	3.9 k $\Omega$	Panasonic	2397722
R70, R80, R81, R82, R83, R84	6	0 $\Omega$	Panasonic	P0.0GCT-ND
R78, R79	2	4.7 k $\Omega$	Panasonic	P4.70KHCT-ND
R91	1	2.7 k $\Omega$	Panasonic	2303171
R92	1	4.7 k $\Omega$	Panasonic	P4.70KHCT-ND
R99	1	0 $\Omega$	Vishay	71-RCS12060000Z0EA
SB1, SB2, SB3, SB4, SB5, SB6	6	Spacer M3 F/F 50 HEX7		732-10660-ND
SHC1, SHC2, SHC3, SHC4, SHC5, SHC6	6	M3x16 DIN7985		
ST1, ST2, ST3, ST4, ST5, ST6	6	Spacer M3 M/F 6/30 HEX7		732-10465-ND
U1	1	NCP1063AD060R2G	ON Semiconductor	NCP1063AD060R2GOSCT-ND
U2	1	NCP718BSN330T1G	ON Semiconductor	NCP718BSN330T1GOSCT-ND
U3	1	FAN8303MX	ON Semiconductor	FAN8303MXCT-ND
U4	1	FDC6326L	ON Semiconductor	512-FDC6326L
U5	1	IPM	ON Semiconductor	NFAM5065L4B-ND
U6, U7, U8	3	NCS20166	ON Semiconductor	NCS20166SN2T1G
U9	1	TLV431	ON Semiconductor	863-TLV431CSN1T1G
U10	1	NCS2250SN2T3G	ON Semiconductor	
U14	1	CAT24C512	ON Semiconductor	CAT24C512WI-GT3OSCT-ND
U_OUT, V_OUT, VB_U, W_OUT	4	PTH testpoint eyelet	Keystone Electronics	36-5005-ND



# SECO-MDK-4KW-65SPM31-GEVB

## Layouts

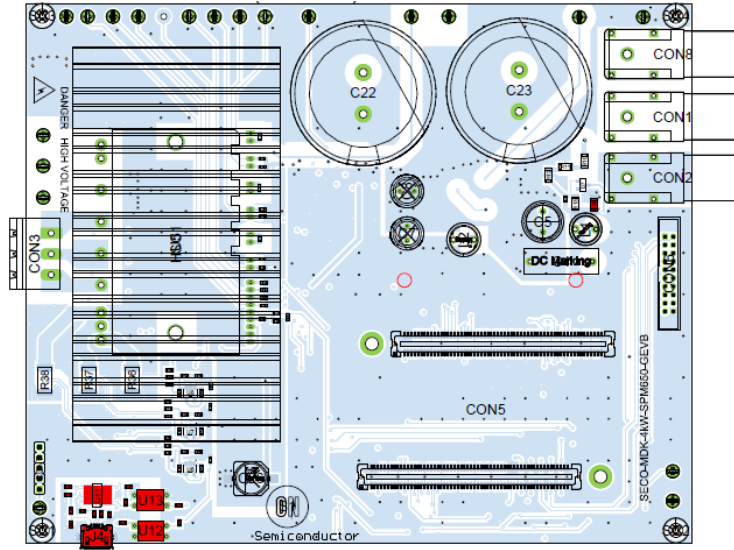

Figure 29. Top Layer Routing and Top Assembly

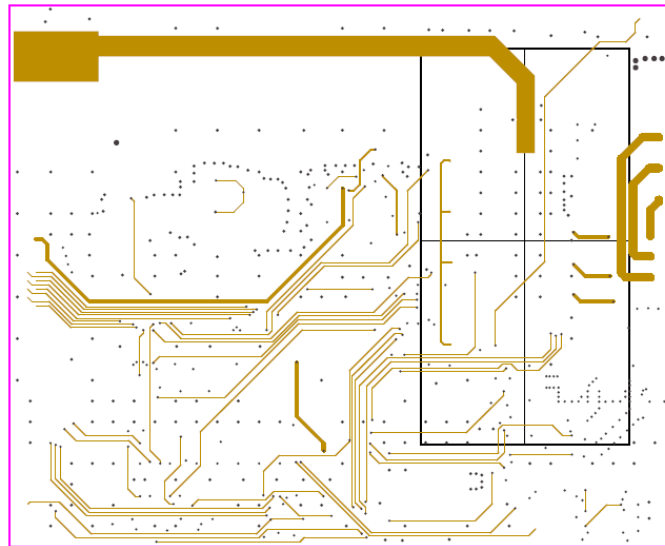

Figure 30. Internal Layer 1

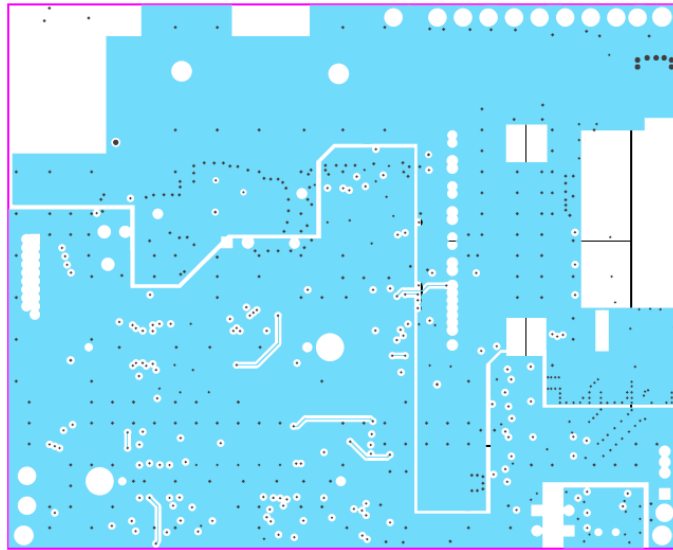

Figure 31. Internal Layer 2

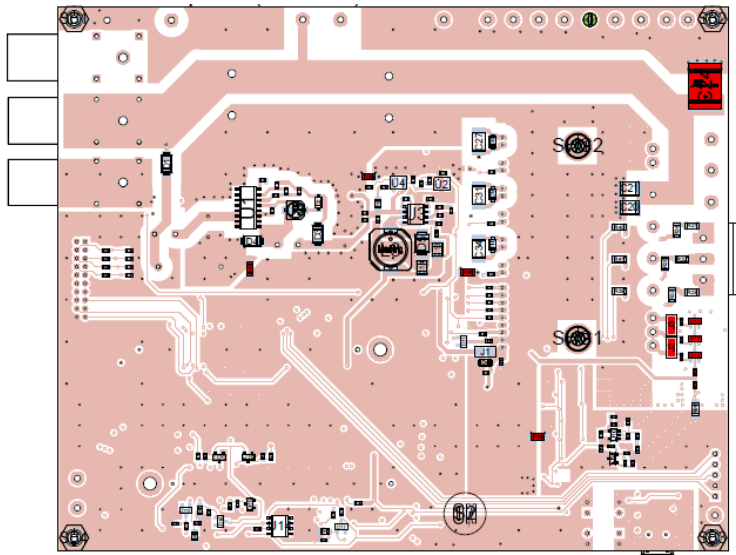

Figure 32. Bottom Layer Routing and Bottom Assembly

# SECO-MDK-4KW-65SPM31-GEVB

## APPENDIX

Table 5 recaps all the signals and low-voltage rails that are routed throughout abovementioned connectors. It is noted that CON4 and CON5 host the majority of those signals, which are mainly used for the interaction between

the *UCB* controller and *NFAM5065L4B* inverter stage. However, as CON4 and CON5 host 240 pins, we will only partially address those.

**Table 5. MDK\_SPM31 INTERFACE**

MDK INTERFACE	CONNECTOR Pin	MDK	IPM	NET LABEL	Connection Description
CON4	70	U11		UART_TX	Transmitting Data to <b>UCB</b> from <b>U11</b> (USB to BASICUART IC)
	71	U11		UART_RX	Receiving Data to <b>U11</b> from <b>UCB</b> (USB to BASICUART IC)
	106			ADC_1_P	I_U current sense
	109			ADC_3_P	I_W current sense
	112			ADC_5_P	IPM Input DC-Link V_DCLINK
	115	CON6 p5		ADC_7_P	Pin 5 of <b>CON6</b> via R82
	118			ADC_9_P	<b>IPM</b> Output Voltage ZC_V
	46			ADC_2_P	I_V current sense
	49		IPM p20	ADC_4_P	TEMPERATURE from <b>IPM</b> p20
	52	CON6 p4		ADC_6_P	Pin 4 of <b>CON6</b> via R81
	55			ADC_8_P	<b>IPM</b> Output Voltage ZC_U
	58			ADC_10_P	<b>IPM</b> Output Voltage ZC_W
	1, 2, 3, 43, 44	CON7 p1		5V	<b>From the Auxiliary power Supply or UCB</b>
	9, 12, 17, 22, 27, 32, 37, 42, 45, 47, 48, 50, 51, 53, 54, 56, 57, 59, 60, 61, 62, 63, 66, 69, 72, 77, 82, 87, 92, 97, 102, 103, 104, 105, 107, 108, 110, 111, 113, 114, 116, 117, 119, 120	CON7 p2	IPM p27 via R99	S_GND	<b>UCB</b> Ground  Connects to IPm p27 (G_IPM) via R99
	11	To 5V via R70		UART_OB_DISABLE	If R70 is soldered the UART of <b>UCB</b> is disabled
	13	U14 p6		DIO_1_1	I <sup>2</sup> C SCL to U14 (EEPROM)
	14	U14 p5		DIO_1_2	I <sup>2</sup> C SDA to U14 (EEPROM)
	15		IPM p26	DIO_1_3	<b>IPM</b> Disable Pin p26 via D11 & R20
	16		IPM p24	DIO_1_4	<b>IPM</b> Fault Pin p24
	18	CON6 p2		DIO_1_5	<b>SPI</b> via CON 6 (SCLK)
19	CON6 p3		DIO_1_6	<b>SPI</b> via CON 6 (MOSI)	
20	CON6 p7		DIO_1_7	<b>SPI</b> via CON 6 (MISO)	
21	ITRIP from U10		DIO_1_8	ITRIP signal from <b>U10</b> (NCS2250SN2T3G comparator)	
CON5	70	POWER_OK from U4		POWER_OK	From p4 U4 (Power Switch ICs FDC6326L)
	73	CON6 p10		DIO_2_1	For CAN (Rx)
	74	CON6 p11		DIO_2_2	For CAN (Tx)
	75	CON6 p12		DIO_2_3	Debug pin avail. at p12 CON6

## SECO-MDK-4KW-65SPM31-GEVB

**Table 5. MDK\_SPM31 INTERFACE** (continued)

MDK INTERFACE	CONNECTOR Pin	MDK	IPM	NET LABEL	Connection Description
	76	CON6 p9		DIO_2_4	Debug pin avail. at p9 CON6
	78	CON7 p5		DIO_2_5 (Note 2)	Debug pin avail. at p5 CON7
	79	CON7 p4		DIO_2_6 (Note 2)	Debug pin avail. at p4 CON7
	80	CON7 p3		DIO_2_7 (Note 2)	Debug pin avail. at p3 CON7
	81	CON6 p13		DIO_2_8	Debug pin avail. at p13 CON6
	103, 104		IPM p6, IPM p21	PWM_0_H, PWM_0_L	PWM0 H/L output to IPM via R14 and R17, respectively
	106, 107		IPMp18, IPM p23	PWM_2_H, PWM_2_L	PWM2 H/L output to IPM via R16 and R19, respectively
	109, 110	CON6 p17, CON6 p16		PWM_4_H, PWM_4_L	PWM4 output
	43, 44		IPMp12, IPM p22	PWM_1_H, PWM_1_L	PWM1 H/L output to IPM via R15 and R18, respectively
	46, 47	CON6 p15, CON6 p14		PWM_3_H, PWM_3_L	PWM3 output
	49, 50	CON6 p18, CON6 p19		PWM_5_H, PWM_5_L	PWM5 output
	9, 12, 17, 22, 27, 32, 37, 42, 45, 48, 51, 54, 6, 57, 60, 61, 62, 63, 69, 72, 77, 82, 87, 92, 97, 102, 105, 108, 111, 114, 117, 120	CON7 p2	IPM p27 via R99	S_GND	<b>UCB Ground</b> Connect to IPM p27 (G_IPM) via R99
	1, 2, 3	CON7 p1		5V	<b>From the Auxiliary power Supply or UCB</b>
	<b>CON6</b>	1	U4 p4		15VDC_SW
2				DIO_1_5	<b>SPI</b> via CON 6 (SCLK)
3				DIO_1_6	<b>SPI</b> via CON 6 (MOSI)
7				DIO_1_7	<b>SPI</b> via CON 6 (MISO)
4, 5, 6, 8				ADC_6_P via R81 ADC_7_P via R82 ADC_8_P via R83 ADC_9_P via R84	<b>Connect to ADC port of UCB via CON4</b>
9, 10, 11, 12, 13				DIO_2_4 DIO_2_1 DIO_2_2 DIO_2_3 DIO_2_8	<b>Debug Pins Connect to UCB via CON5</b>
14, 15, 16, 17, 18, 19				PWM_3_L PWM_3_H PWM_4_L PWM_4_H PWM_5_H PWM_5_L	<b>Connect to PWM port of UCB via CON5</b>
20			IPM p27 via R99	S_GND	<b>S_GND (UCB Ground)</b>
<b>CON7</b>	1	CON7 p1		5V	<b>From the Auxiliary power Supply or UCB</b>
	2		IPM p27 via R99	S_GND	<b>S_GND (UCB Ground)</b>
	3			DIO_2_7 (Note 2)	<b>Pin to UCB via CON5</b>
	4			DIO_2_6 (Note 2)	<b>Pin to UCB via CON5</b>
	5			DIO_2_5 (Note 2)	<b>Pin to UCB via CON5</b>

2. Can be used as input from encoder.

## REFERENCES

- [1] [UCB documentation](#).
- [2] [NFAM5065L4B](#) data sheet. Intelligent Power Module (IPM) 6500 V, 50 A.
- [3] [NCP1063](#) data sheet.
- [4] [FAN8303](#) data sheet.
- [5] [NCP718](#) data sheet.
- [6] [NCS20166](#) data sheet.
- [7] [NCS2250](#) data sheet.
- [8] [CAT24C512](#) data sheet.
- [9] [NCD98011](#) data sheet.
- [10] [AND9390/D](#). 3-phase Inverter Power Module for the Compact IPM Series.
- [11] [FPGA Zynq 7000 series](#) data sheet.
- [12] GUI executable and boot-image download [link](#).
- [13] J.A. Santisteban, R.M. Stephan, “Vector control methods for induction machines: an overview,” IEEE Transactions on Education, Vol 44, no 2, pp-170-175, May 2001.
- [14] M. Ahmad, “High Performance AC Drives: Modelling Analysis and Control,” published by Springer-Verlag, 2010.
- [15] J.R Hendershot, T.J.E. Miller, “Design of Brushless Permanent-Magnet Machines,” published in the USA by Motor Design Books LLC, 2010.
- [16] [Boot from flash](#).

ON Semiconductor and the ON Semiconductor logo are trademarks of Semiconductor Components Industries, LLC dba ON Semiconductor or its subsidiaries in the United States and/or other countries. ON Semiconductor owns the rights to a number of patents, trademarks, copyrights, trade secrets, and other intellectual property. A listing of ON Semiconductor's product/patent coverage may be accessed at [www.onsemi.com/site/pdf/Patent-Marking.pdf](http://www.onsemi.com/site/pdf/Patent-Marking.pdf). ON Semiconductor is an Equal Opportunity/Affirmative Action Employer. This literature is subject to all applicable copyright laws and is not for resale in any manner.

The evaluation board/kit (research and development board/kit) (hereinafter the "board") is not a finished product and is as such not available for sale to consumers. The board is only intended for research, development, demonstration and evaluation purposes and should as such only be used in laboratory/development areas by persons with an engineering/technical training and familiar with the risks associated with handling electrical/mechanical components, systems and subsystems. This person assumes full responsibility/liability for proper and safe handling. Any other use, resale or redistribution for any other purpose is strictly prohibited.

The board is delivered "AS IS" and without warranty of any kind including, but not limited to, that the board is production-worthy, that the functions contained in the board will meet your requirements, or that the operation of the board will be uninterrupted or error free. ON Semiconductor expressly disclaims all warranties, express, implied or otherwise, including without limitation, warranties of fitness for a particular purpose and non-infringement of intellectual property rights.

ON Semiconductor reserves the right to make changes without further notice to any board.

You are responsible for determining whether the board will be suitable for your intended use or application or will achieve your intended results. Prior to using or distributing any systems that have been evaluated, designed or tested using the board, you agree to test and validate your design to confirm the functionality for your application. Any technical, applications or design information or advice, quality characterization, reliability data or other services provided by ON Semiconductor shall not constitute any representation or warranty by ON Semiconductor, and no additional obligations or liabilities shall arise from ON Semiconductor having provided such information or services.

The boards are not designed, intended, or authorized for use in life support systems, or any FDA Class 3 medical devices or medical devices with a similar or equivalent classification in a foreign jurisdiction, or any devices intended for implantation in the human body. Should you purchase or use the board for any such unintended or unauthorized application, you shall indemnify and hold ON Semiconductor and its officers, employees, subsidiaries, affiliates, and distributors harmless against all claims, costs, damages, and expenses, and reasonable attorney fees arising out of, directly or indirectly, any claim of personal injury or death associated with such unintended or unauthorized use, even if such claim alleges that ON Semiconductor was negligent regarding the design or manufacture of the board.

This evaluation board/kit does not fall within the scope of the European Union directives regarding electromagnetic compatibility, restricted substances (RoHS), recycling (WEEE), FCC, CE or UL, and may not meet the technical requirements of these or other related directives.

**FCC WARNING** – This evaluation board/kit is intended for use for engineering development, demonstration, or evaluation purposes only and is not considered by ON Semiconductor to be a finished end product fit for general consumer use. It may generate, use, or radiate radio frequency energy and has not been tested for compliance with the limits of computing devices pursuant to part 15 of FCC rules, which are designed to provide reasonable protection against radio frequency interference. Operation of this equipment may cause interference with radio communications, in which case the user shall be responsible, at its expense, to take whatever measures may be required to correct this interference.

ON Semiconductor does not convey any license under its patent rights nor the rights of others.

**LIMITATIONS OF LIABILITY:** ON Semiconductor shall not be liable for any special, consequential, incidental, indirect or punitive damages, including, but not limited to the costs of requalification, delay, loss of profits or goodwill, arising out of or in connection with the board, even if ON Semiconductor is advised of the possibility of such damages. In no event shall ON Semiconductor's aggregate liability from any obligation arising out of or in connection with the board, under any theory of liability, exceed the purchase price paid for the board, if any.

For more information and documentation, please visit [www.onsemi.com](http://www.onsemi.com).

---

## PUBLICATION ORDERING INFORMATION

### LITERATURE FULFILLMENT:

Email Requests to: [orderlit@onsemi.com](mailto:orderlit@onsemi.com)

ON Semiconductor Website: [www.onsemi.com](http://www.onsemi.com)

### TECHNICAL SUPPORT

North American Technical Support:

Voice Mail: 1 800-282-9855 Toll Free USA/Canada

Phone: 011 421 33 790 2910

Europe, Middle East and Africa Technical Support:

Phone: 00421 33 790 2910

For additional information, please contact your local Sales Representative