

Customer Information Sheet

DRAWING No.: S8201-46R

SHEET 2 OF 2

IF IN DOUBT - ASK

©

NOT TO SCALE

THIRD ANGLE PROJECTION

ALL DIMENSIONS IN mm

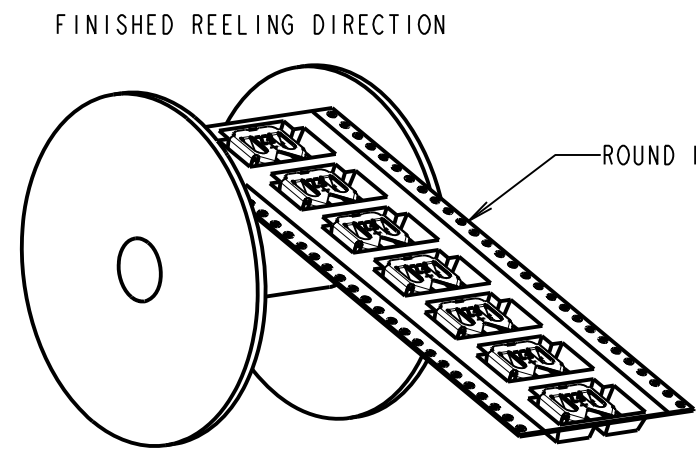
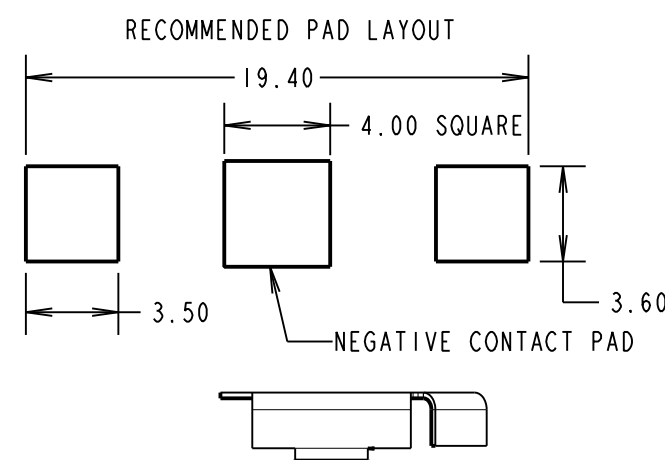
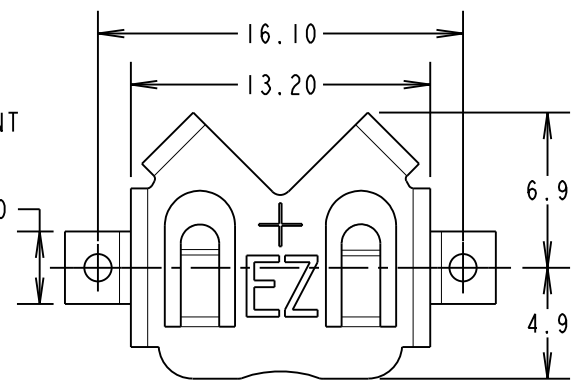
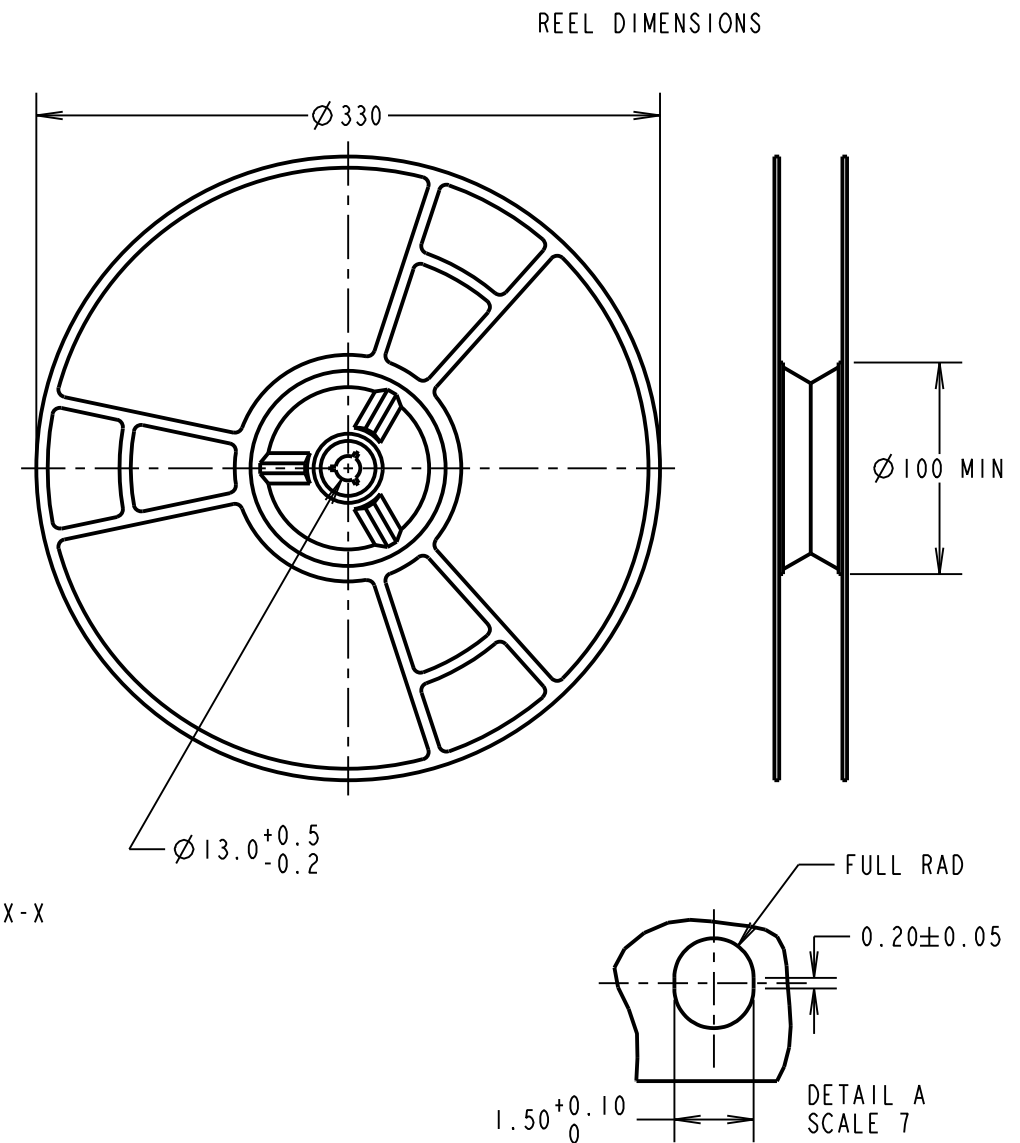
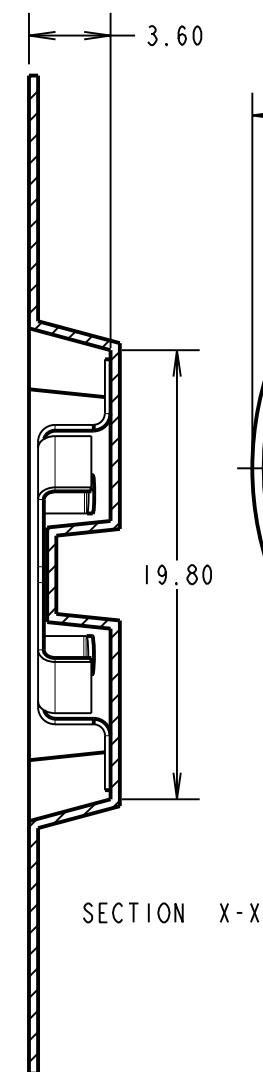
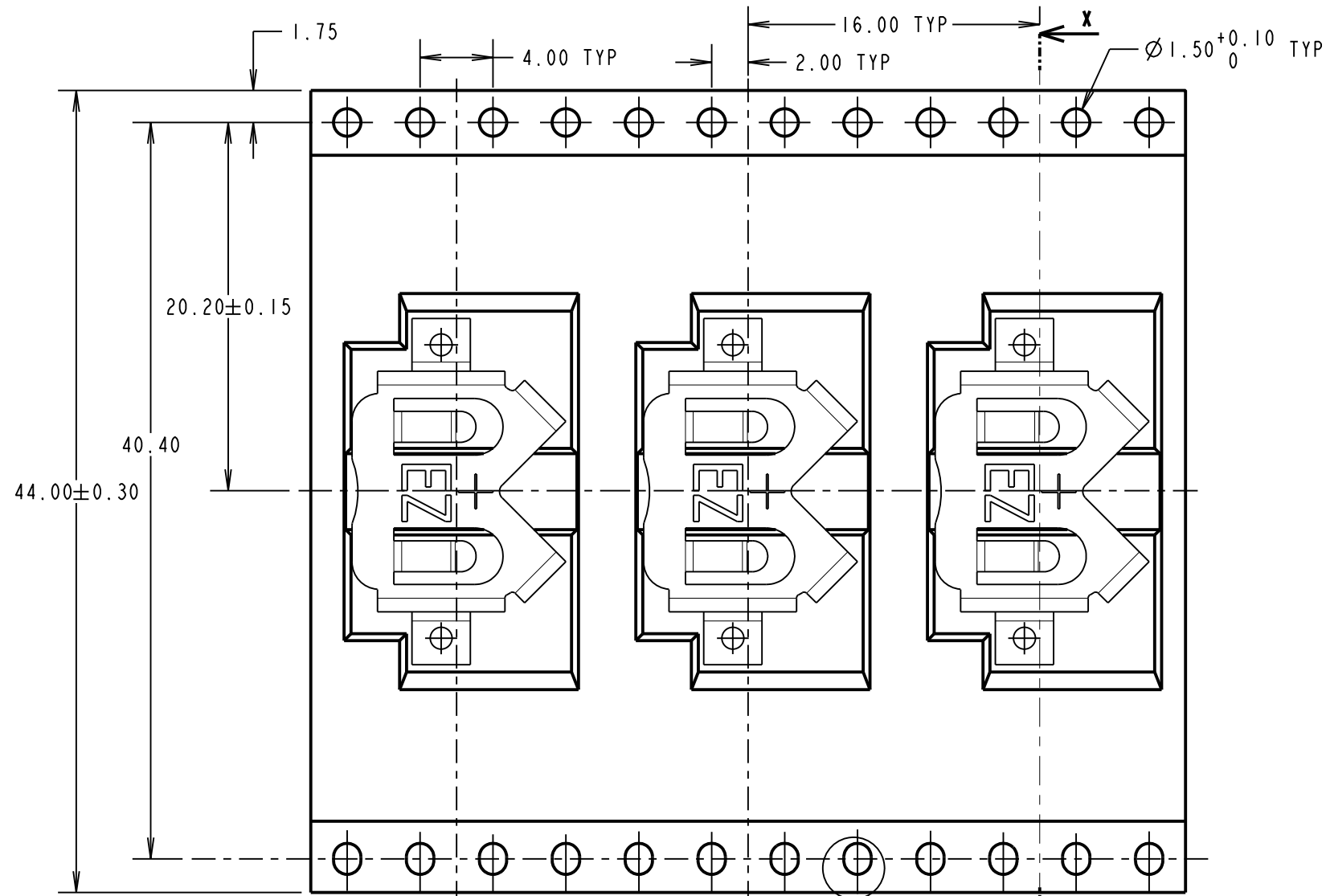

SPECIFICATION:
MATERIAL = PHOSPHOR BRONZE
FINISH:
46 = 3µ 100% TIN, OVER NICKEL

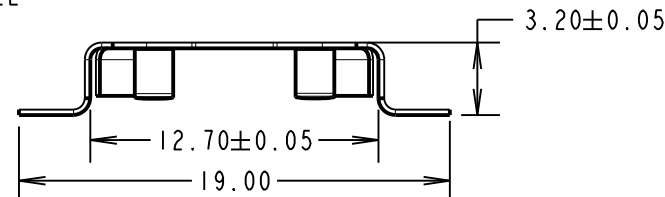

- NOTES:
1. QUANTITY PER REEL = 1000
 2. THIS PRODUCT IS TAPED AND REELED IN ACCORDANCE WITH EIA-481-2-A (ELECTRONIC INDUSTRIES ASSOCIATION).
 3. THIS PRODUCT IS SUITABLE FOR THE FOLLOWING BATTERIES: BR1220, BR1225, CR1220 AND CR1225.

HARWIN
www.harwin.com
technical@harwin.com

THIS DRAWING AND ANY INFORMATION OR DESCRIPTIVE MATTER SET OUT HEREON ARE CONFIDENTIAL AND COPYRIGHT PROPERTY OF THE HARWIN GROUP AND MUST NOT BE DISCLOSED, LOANED, COPIED OR USED FOR MANUFACTURING, TENDERING OR FOR ANY OTHER PURPOSE WITHOUT THEIR WRITTEN PERMISSION.

TOLERANCES
X. = ±1mm
X.X = ±0.25mm
X.XX = ±0.10mm
X.XXX = ±0.01mm
ANGLES = ±5°
UNLESS STATED

MATERIAL: SEE ABOVE
FINISH: SEE ABOVE
S/AREA: mm²

TITLE: COIN CELL RETAINER (12mm) (TAPE & REELED)
DRAWING NUMBER: S8201-46R
ASSEMBLY DRG:

MGP	1	26.04.12	11715
NAME	ISS.	DATE	C/NOTE
APPROVED: MGP			
CHECKED: SF			
DRAWN: R.ADDE			
CUSTOMER REF.:			
ASSEMBLY DRG:			