

Multifunctional through hole DIP switches

Features

Optimized Mechanical Features

- Series 206 SPST, SPDT, DPST, DPDT, 3PST or 4PST circuitry choices
- Series 206 and Series 208 SPST available in 2 through 10 and 12 positions
- Standard 2.54mm (.100") x 7.62mm (.300") DIP centers
- Available with flush actuators for low profile SPST applications
- Sealed version optional; assures contaminant-free switch operation after flow soldering and cleaning

Optimized Contact System

- Contact wiping on make and break
- Integral terminal and contact locked into thermoset base
- Electrostatic discharge shield rated to 22 KV

Materials

- Series 206 gold-plated contacts for long-term contact corrosion resistance
- Series 208 tin-lead contacts
- All U.L. 94 V-0 plastics used

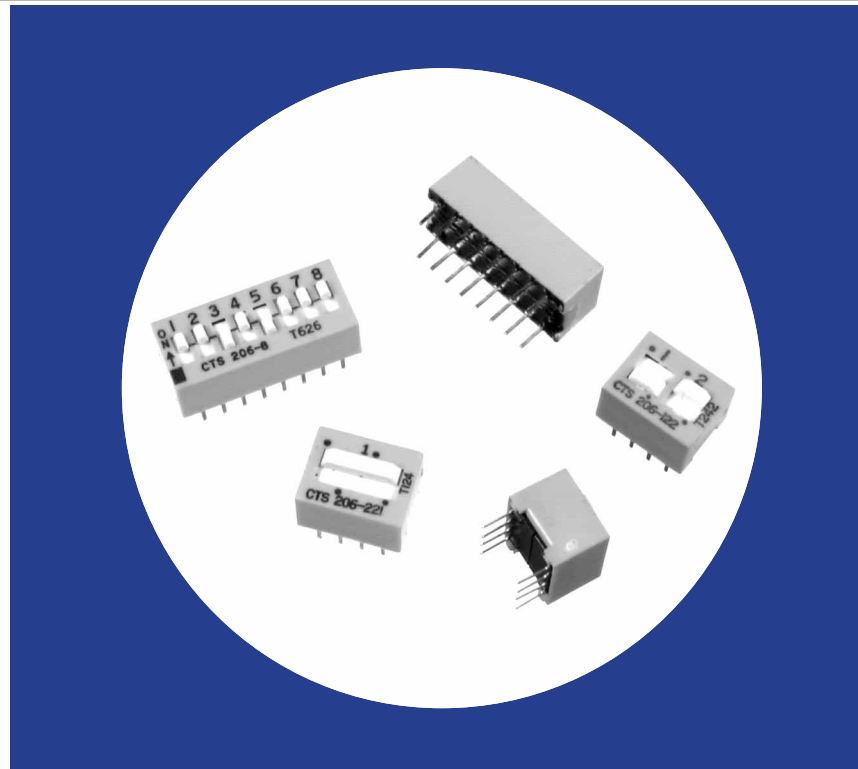

Series 206 – Premium Gold Plated Contacts
Series 208 – Economical Tin-Lead Plated Contacts

Electrical and Mechanical Specifications

Switch Function

- Series 206 and 208 single pole single throw
- Series 206 - single pole double throw
- double pole single throw
 - double pole double throw
 - 3 pole single throw
 - 4 pole single throw

Switch Contact Resistance

Switch Series	Initial, max.	End of life, max.
206	50 milliohms	100 milliohms
208	100 milliohms	500 milliohms

Insulation Resistance

- 1,000 megohms minimum across open switch
- 1,000 megohms minimum between adjacent closed switches

Dielectric Strength

- 500 VAC minimum for 1 minute between adjacent switches

Nonswitching Rating

- 100 mA or 50 VDC

Switch Capacitance

- 5.0 pF maximum between adjacent switches

Operating Temperature

- 55°C to +85°C

Actuation Life

- Series 206: 10,000 cycles switching
50 mA @ 24 VDC
- Series 208: 2,000 cycles switching
50 mA @ 15 VDC

Allowable Solder Time

- Up to 4 seconds with 260°C solder

Vibration

- Per MIL-STD-202F, method 204D, condition B with no contact inconsistencies greater than 1 microsecond

Shock

- Per MIL-STD-202F, method 213B, condition A with no contact inconsistencies greater than 1 microsecond

Sealing

- Bottom epoxy seal optional
- Top tape seal optional

Marking

- Special side or top marking available-consult CTS

SPST – Series 206 and Series 208

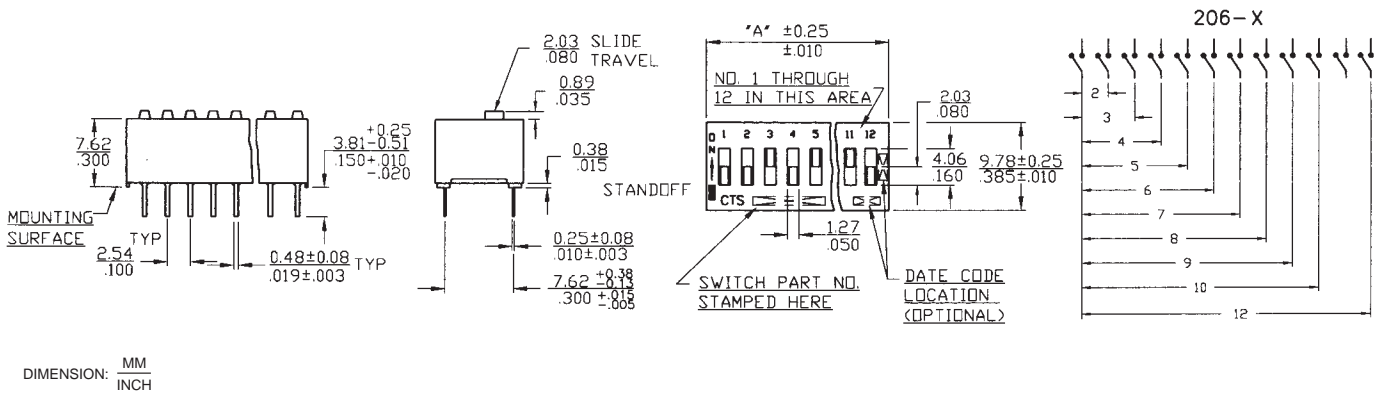

SPDT – Series 206

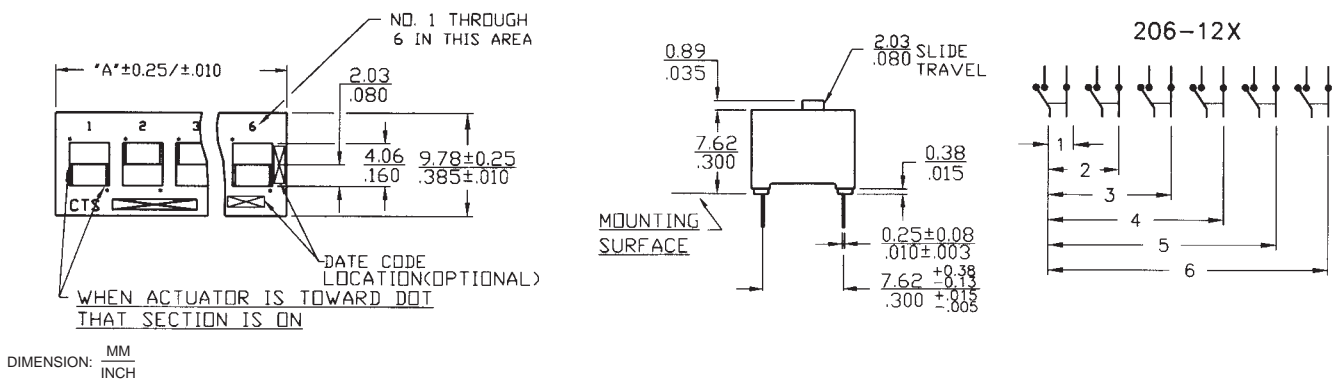

DPST – Series 206

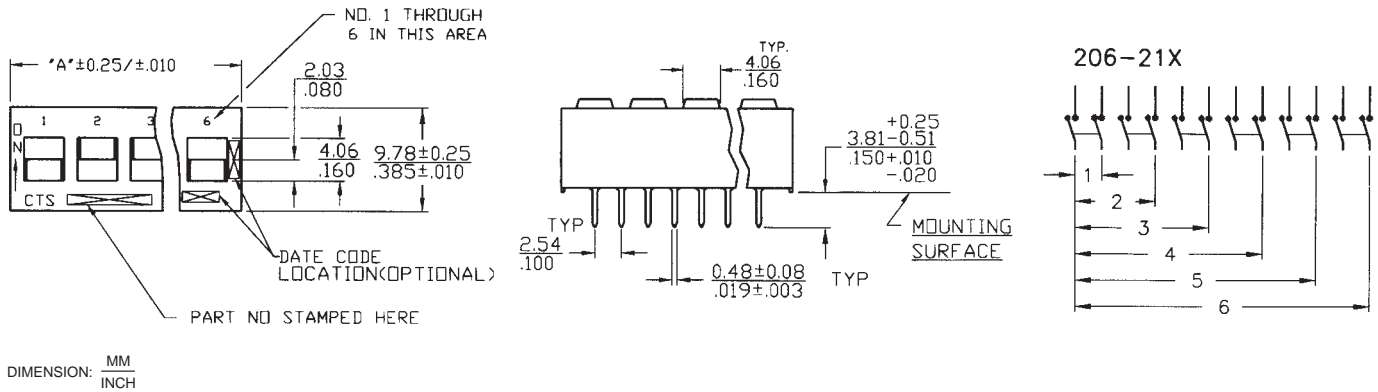

DPDT – Series 206

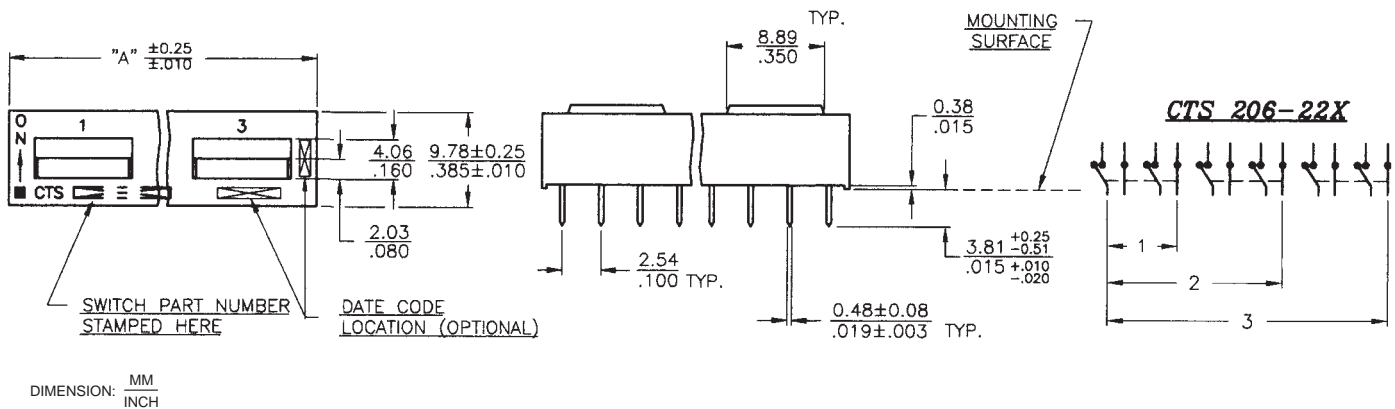

3PST – Series 206

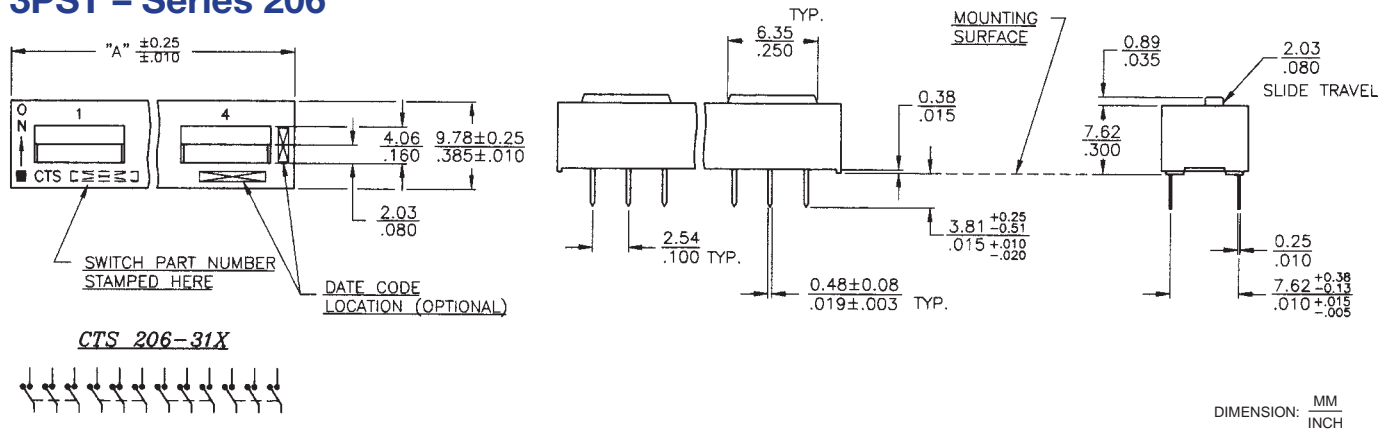

4PST – Series 206

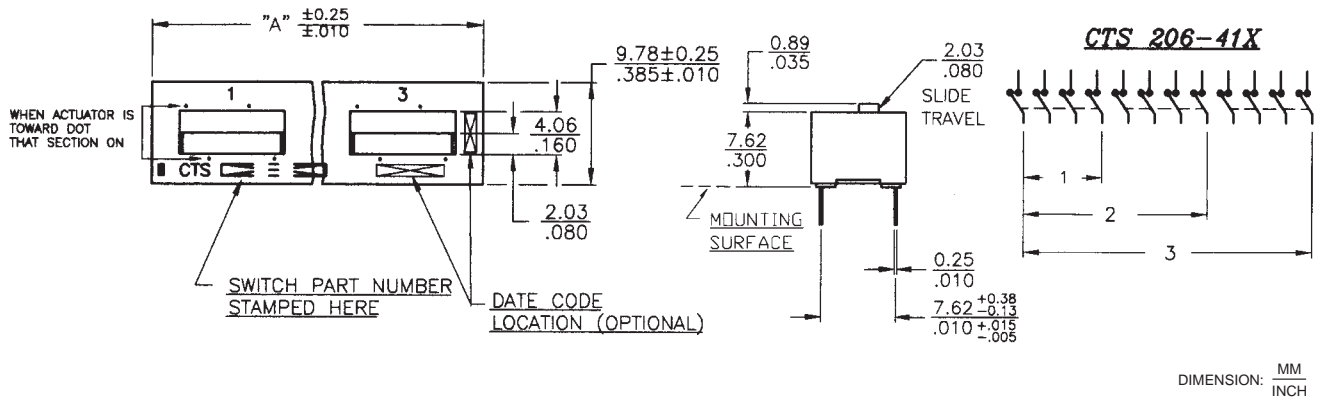

Low Profile Actuators – Series 206 and Series 208, SPST

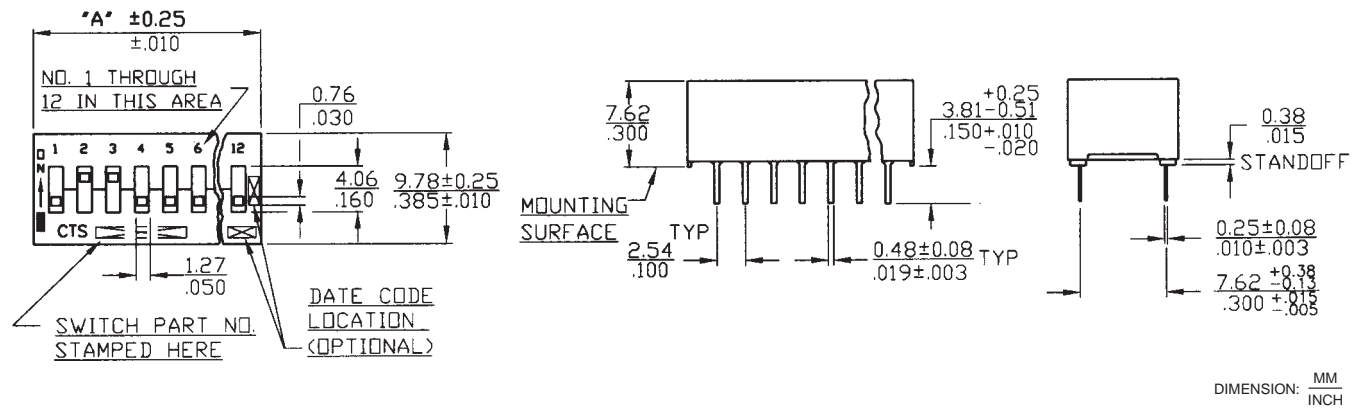

Extended Actuators – Series 206, SPST

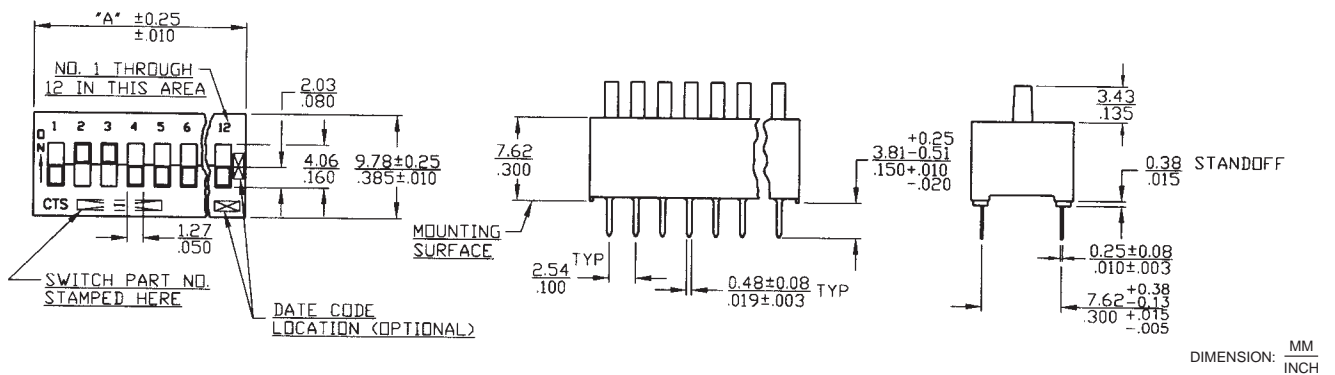

Part Numbering Information

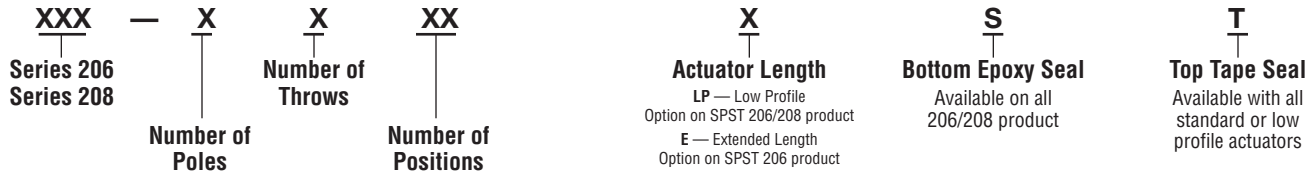

Ordering Information

“A” Overall Dimensions	Number of Switch Sections	Actuation	Part Number	Both Bottom and Top Sealed	Low Profile Both Bottom and Top Sealed
7.26 / .286	2	SPST	206/208-2	206/208-2ST	206/208-2LPST
9.80 / .386	3	SPST	206/208-3	206/208-3ST	206/208-3LPST
12.34 / .486	4	SPST	206/208-4	206/208-4ST	206/208-4LPST
14.88 / .586	5	SPST	206/208-5	206/208-5ST	206/208-5LPST
17.42 / .686	6	SPST	206/208-6	206/208-6ST	206/208-6LPST
19.96 / .786	7	SPST	206/208-7	206/208-7ST	206/208-7LPST
22.50 / .886	8	SPST	206/208-8	206/208-8ST	206/208-8LPST
25.04 / .986	9	SPST	206/208-9	206/208-9ST	206/208-9LPST
27.58 / 1.086	10	SPST	206/208-10	206/208-10ST	206/208-10LPST
32.66 / 1.286	12	SPST	206/208-12	206/208-12ST	206/208-12LPST
7.26 / .286	1	SPDT	206-121	206-121ST	
12.34 / .486	2	SPDT	206-122	206-122ST	
17.42 / .686	3	SPDT	206-123	206-123ST	
22.50 / .886	4	SPDT	206-124	206-124ST	
27.58 / 1.086	5	SPDT	206-125	206-125ST	
32.66 / 1.286	6	SPDT	206-126	206-126ST	
7.26 / .286	1	DPST	206-211	206-211ST	
12.34 / .486	2	DPST	206-212	206-212ST	
17.42 / .686	3	DPST	206-213	206-213ST	
22.50 / .886	4	DPST	206-214	206-214ST	
27.58 / 1.086	5	DPST	206-215	206-215ST	
32.66 / 1.286	6	DPST	206-216	206-216ST	
12.34 / .486	1	DPDT	206-221	206-221ST	
22.50 / .886	2	DPDT	206-222	206-222ST	
32.66 / 1.286	3	DPDT	206-223	206-223ST	
9.80 / .386	1	3PST	206-311	206-311ST	
17.42 / .686	2	3PST	206-312	206-312ST	
25.04 / .986	3	3PST	206-313	206-313ST	
32.66 / 1.286	4	3PST	206-314	206-314ST	
12.34 / .486	1	4PST	206-411	206-411ST	
22.50 / .886	2	4PST	206-412	206-412ST	
32.66 / 1.286	3	4PST	206-413	206-413ST	

Order From:

CTS CORPORATION, ELECTROCOMPONENTS / 1601 Mishawaka Street / Elkhart, Indiana 46514
 North America Toll Free (888) 287-4690 / (219) 296-6700 / FAX: (219) 293-1240 <http://www.ctscorp.com>

CTS COMPONENTS TAIWAN, LTD. / 7, Central 6th Road (Chung Liu Road) / P.O. Box 26-20
 Kaohsiung Export Processing Zone / Kaohsiung, Taiwan, Rep. of China
 (07) 8216145 / FAX: (07) 8417642.8110040