

SPECIFICATION

PATENT PENDING

Part No.	: SGGP.12A
Description	: 12mm GPS/GLONASS/GALILEO SMT Mount Ceramic Patch Antenna 12*12*4mm
Features	: 1575.42 /1602 MHz GPS/GLONASS Antenna 2.67 dBi Peak Gain for GPS/GALILEO Band 2.94 dBi Peak Gain for GLONASS Band 12 x 12 x 4mm dimension SMT direct mount ceramic patch antenna Automotive TS16949 Production and Quality Approved RoHS compliant

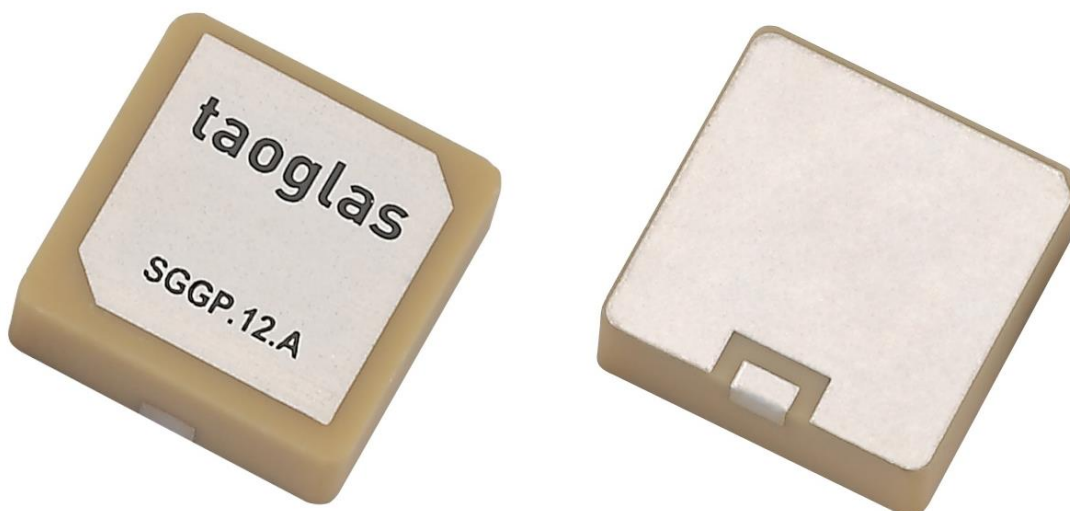

1. Introduction

The SGGP.12.4.A.02 is a ceramic GPS/GLONASS/GALILEO passive patch antenna with low-profile thickness of 4mm. It is designed for applications in navigation devices, vehicle tracking/fleet management systems, and telematics devices. Typical applicable industries are transportation, defense, marine, agriculture, and navigation.

The antenna has been tuned on a 50 x 50 mm ground plane, working at 1575.42MHz and 1602MHz, with a 2.67 dBi gain and 2.94 dBi gain, respectively. The ceramic patch is mounted via SMT process. It is manufactured and tested in a TS16949 first tier automotive approved facility.

For customer specific device environments, custom tuned patch antennas are highly recommended, subject to potential NRE and MOQ. Contact your regional Taoglas sales office for details.

2. Specification

ELECTRICAL		
Application Bands	GPS/GALILEO	GLONASS
Operation Frequency (MHz)	1575.42 ±1.023	1602±5
Return Loss (dB)	< -10	< -10
Gain at Zenith (dBi)	2.67	2.94
Efficiency (%)	60.78	60.58
Impedance	50 ohms	
MECHANICAL		
Ceramic Dimension (mm)	12 x 12 x 4	
Weight (g)	3.3	
ENVIRONMENTAL		
Operation Temperature	-40°C to 85°C	
Humidity	Non-condensing 65°C 95% RH	

* Antenna properties were measured with the antenna mounted on 50*50mm Ground Plane
Taoglas Part # SGGPD.12A

3. Antenna Characteristics

3.1. Return Loss

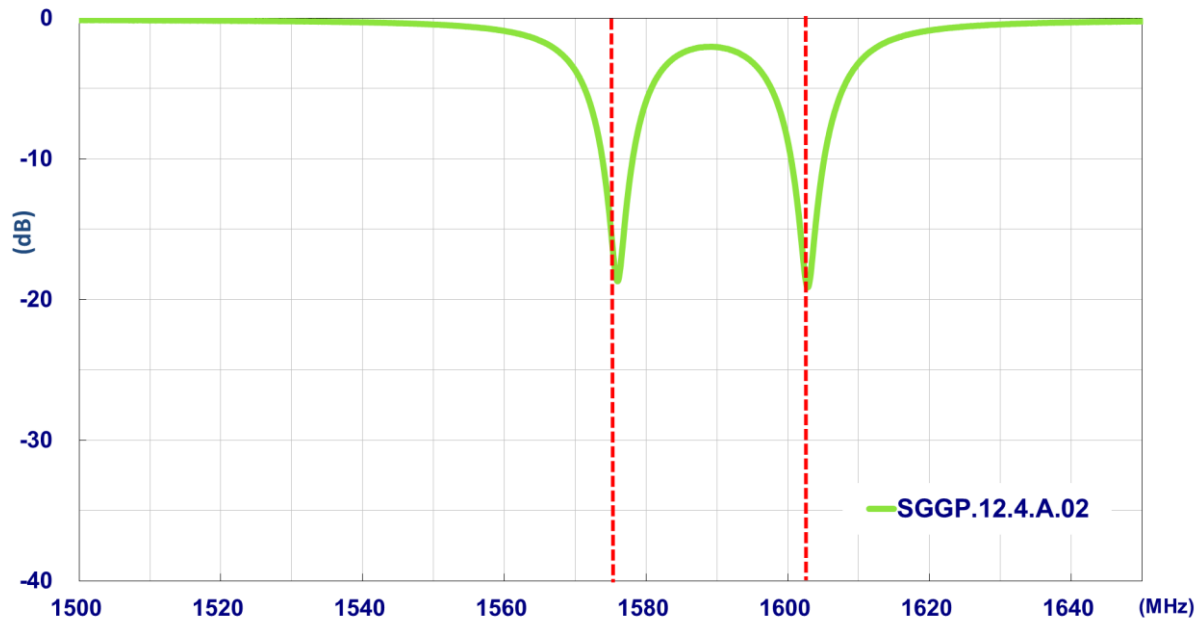

3.2. Efficiency

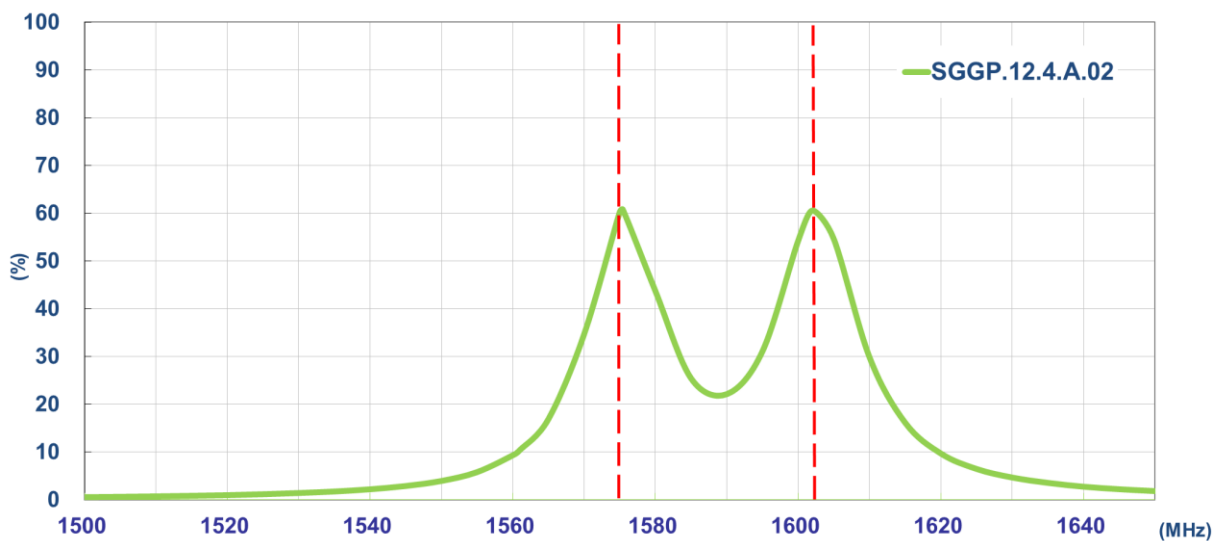

3.3. Average Gain

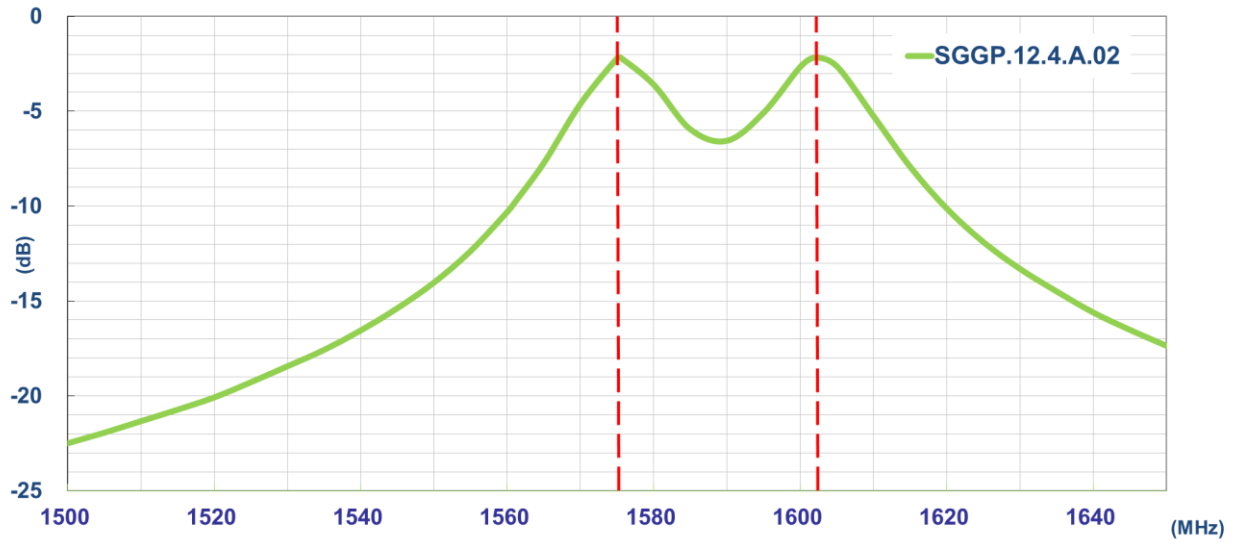

3.4. Peak Gain

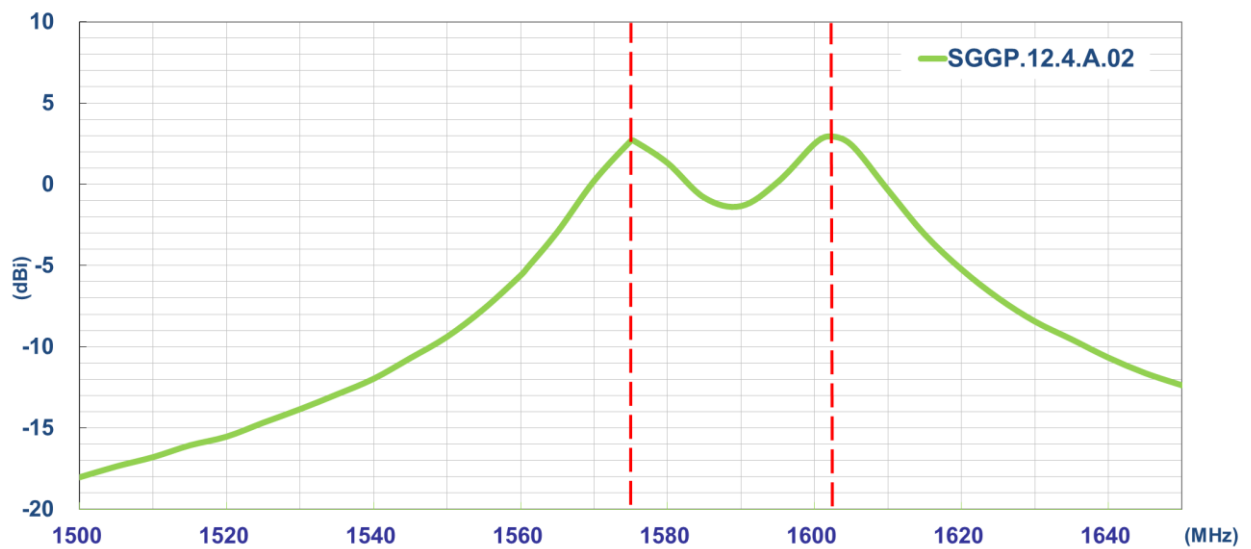

4. Antenna Radiation Pattern

4.1. Measurement Setup

The SGGP.12.4.A.02 antenna is tested with 50mm*50mm ground plane in a CTIA certified ETS-Lindgren Anechoic Chamber. The test setup is shown below.

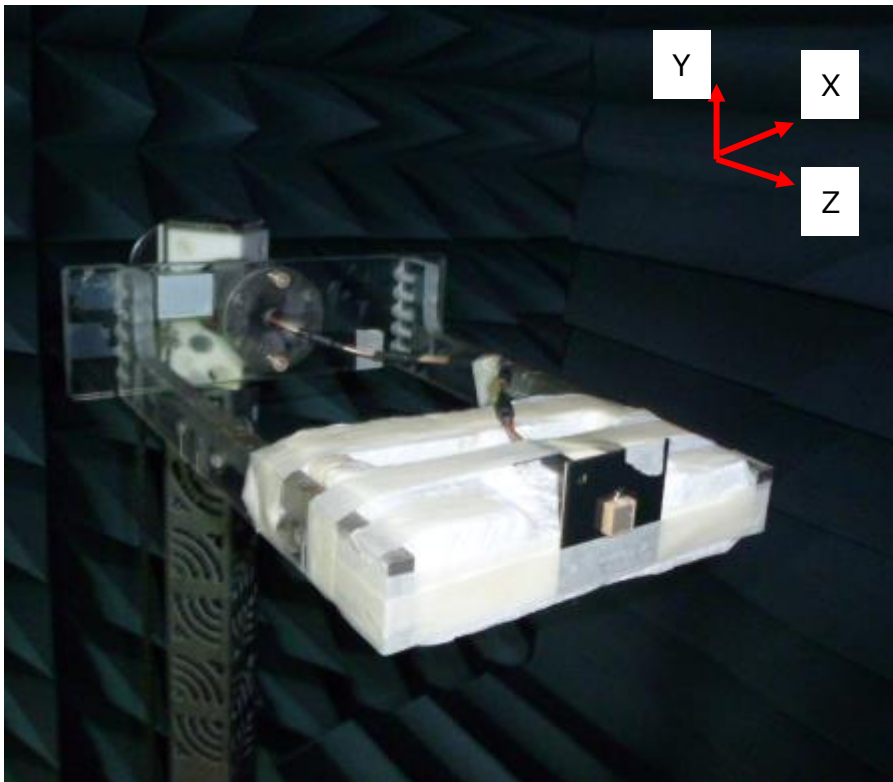

4.2. 2D Radiation Pattern

XY Plane

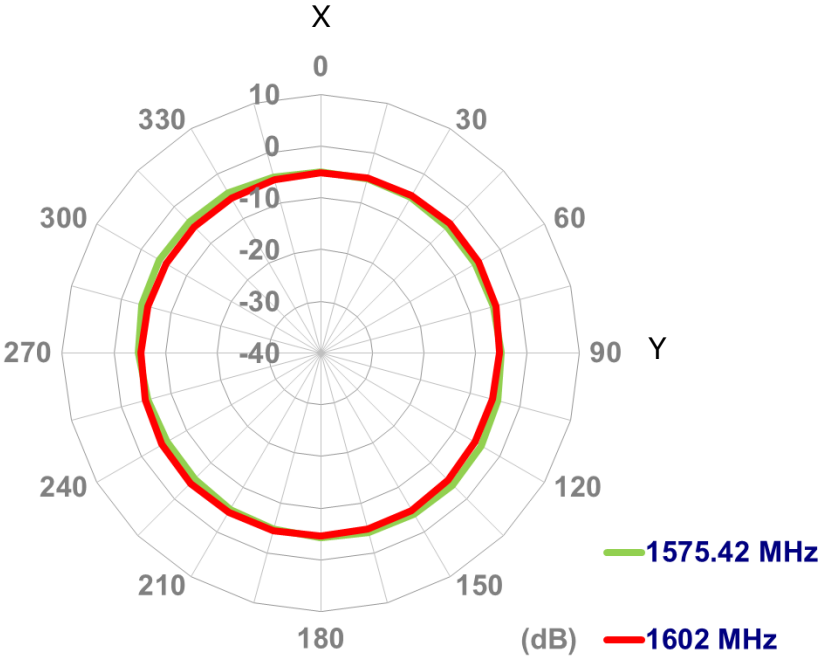

XZ Plane

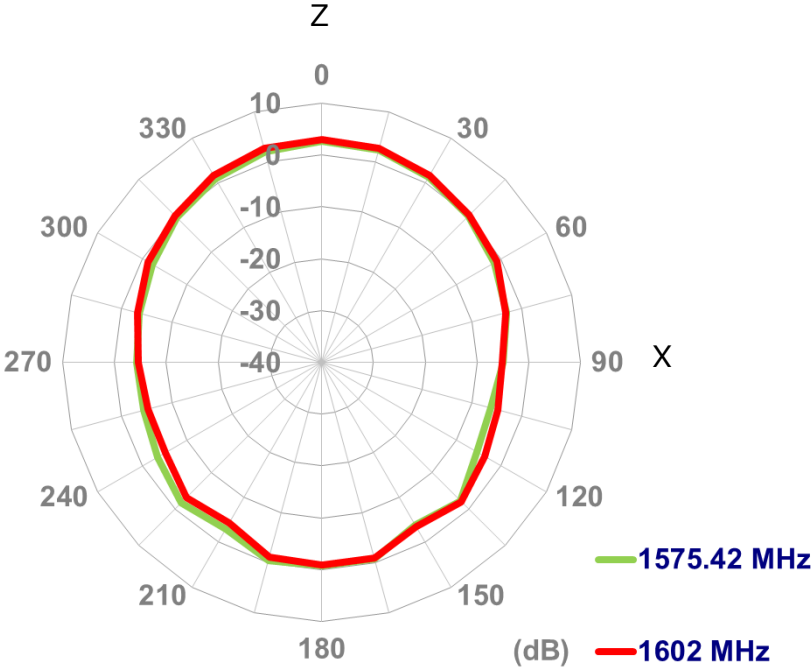

YZ Plane

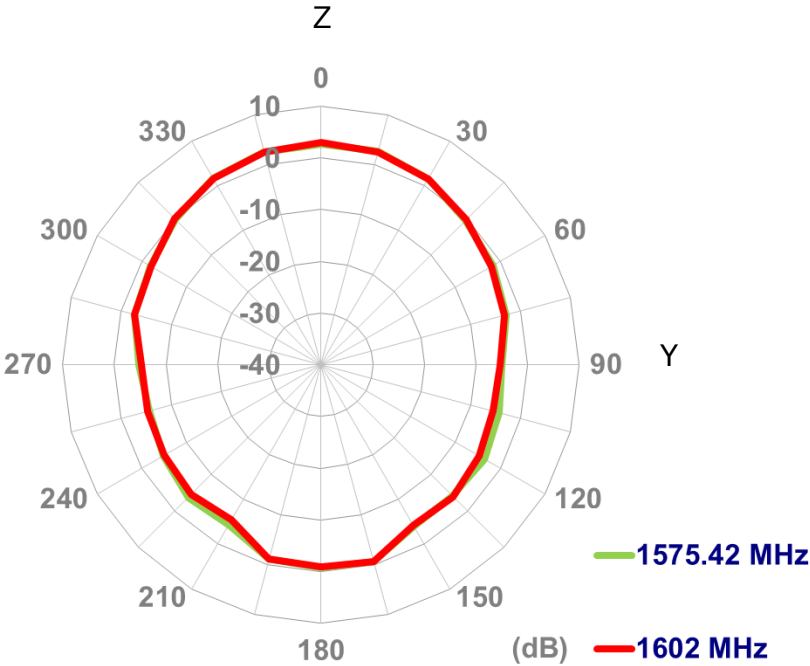

4.3. 3D Radiation Pattern

1575.42MHz

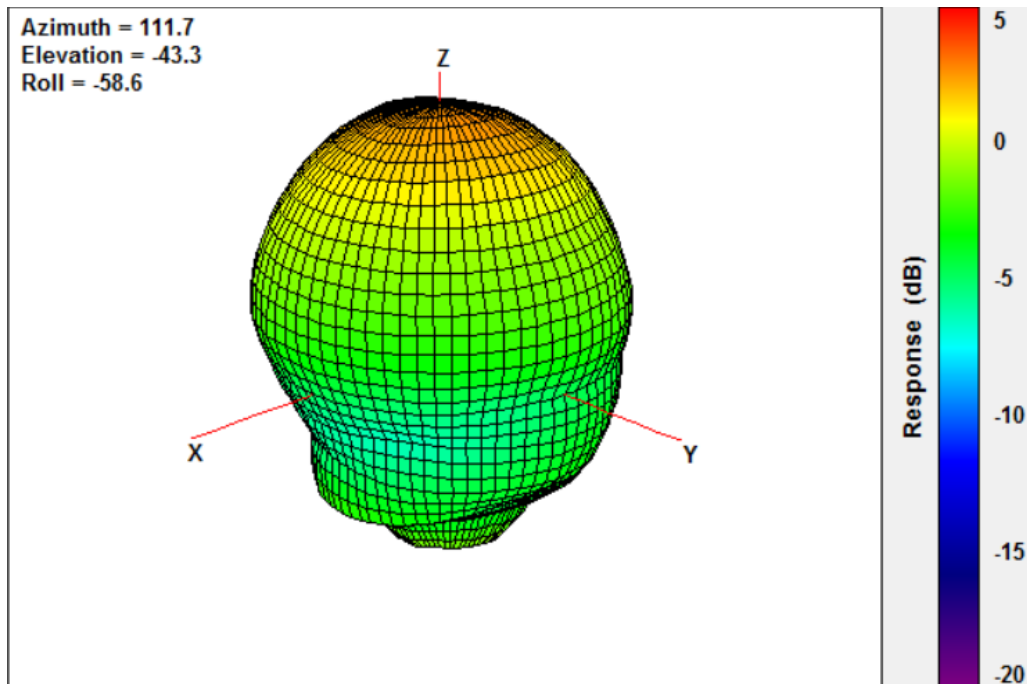

1602MHz

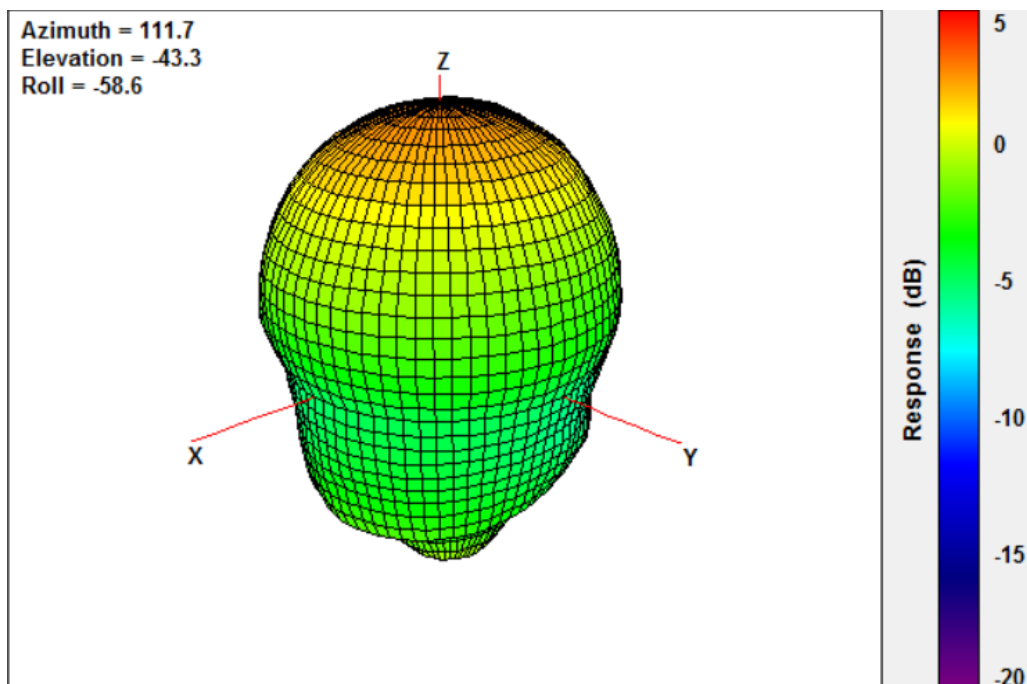

5. Mechanical Drawing

Top View

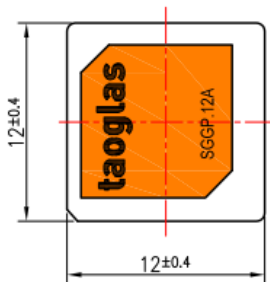

Side View



Bottom View

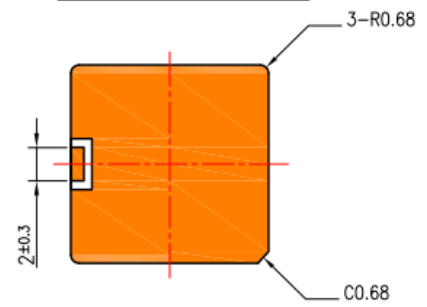

Unit:mm

6. Evaluation Board (SGGP.12A)

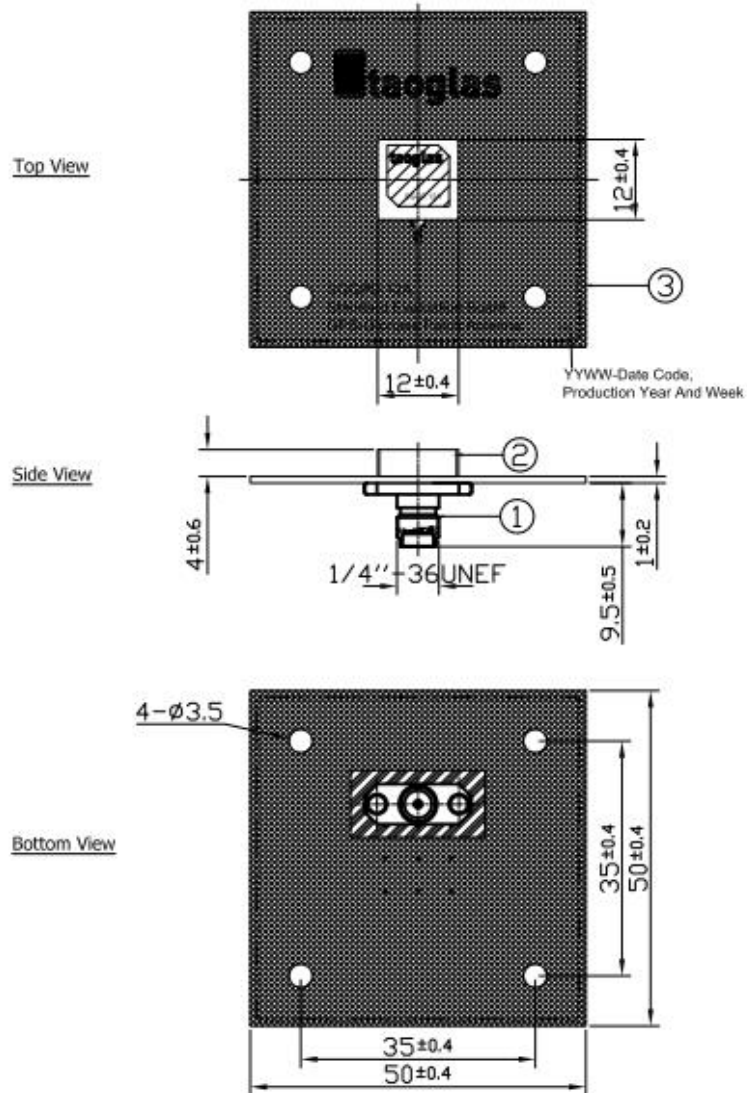

Unit:mm

- Notes
1. Silver area
 2. Solder mask
 3. Solder Area



	Name	Material	Finish	QTY
1	PCB SMA(F) ST	Brass	Gold	1
2	SGGP.12.4.A.02 Antenna	Ceramic	Clear	1
3	PCB (50x50x1mm)	FR4 1.0t	Black	1



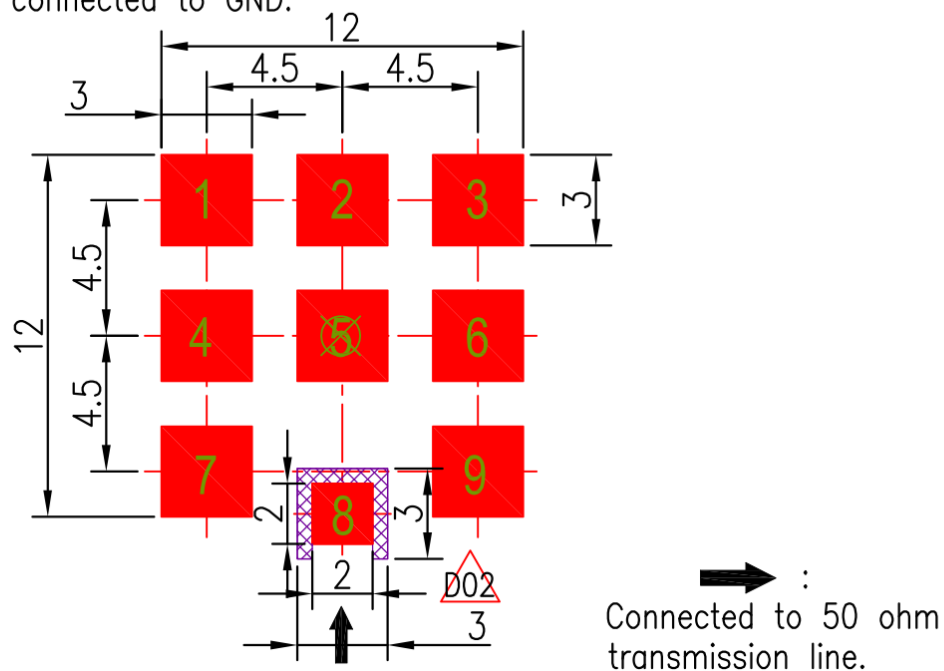

7. PCB Footprint Recommendation

7.1. Footprint Copper Keepout Area (unit: mm)

Pads 1, 2, 3, 4, 5, 6, 7 and 9 are the same size. They should be connected to GND.



NOTE:

- | | |
|------------------------|---|
| 1. Ag Plated area |  |
| 2. Solder Mask area |  |
| 3. Copper area |  |
| 4. Paste area |  |
| 5. Copper Keepout Area |  |



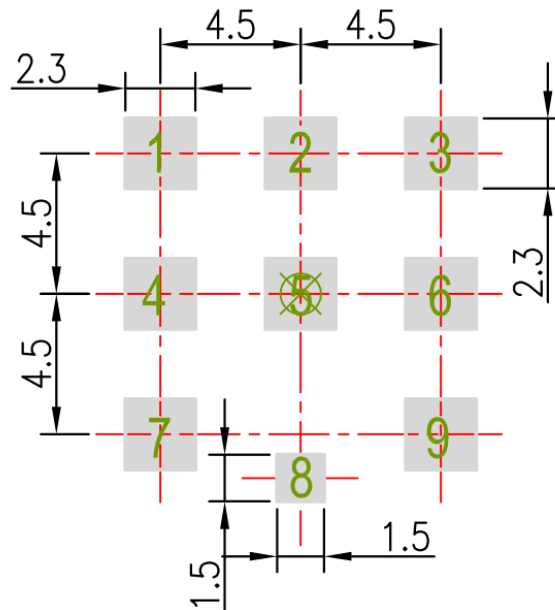

6. Copper keepout should extend through all PCB layers.
7. Any vias in pads should be either filled or tented to prevent solder from wicking away from the pad during reflow.
8. The dimension tolerances should follow standard PCB manufacturing guidelines

7.2. Paste Area (unit: mm)

Pads 1, 2, 3, 4, 5, 6, 7 and 9 are the same size.



NOTE:



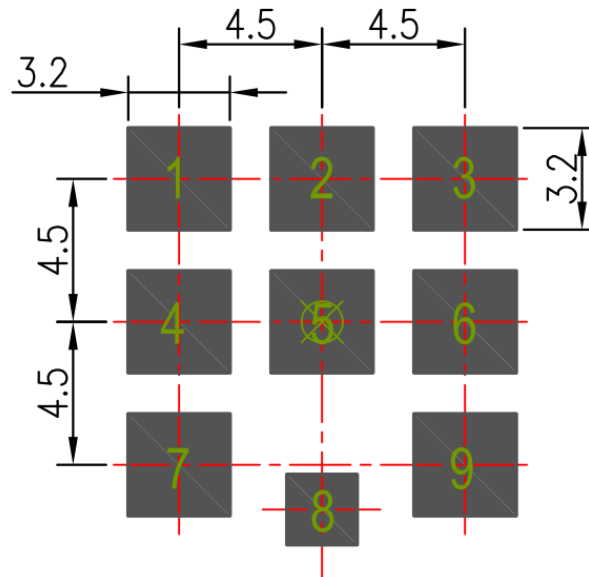

1. Ag Plated area 
2. Solder Mask area 
3. Copper area 
4. Paste area 
5. Copper Keepout Area 
6. Copper keepout should extend through all PCB layers.
7. Any vias in pads should be either filled or tented to prevent solder from wicking away from the pad during reflow.
8. The dimension tolerances should follow standard PCB manufacturing guidelines

7.3. Top Solder Mask(unit: mm)

Pads 1, 2, 3, 4, 5, 6, 7 and 9 are the same size,
This drawing is a negative of solder mask. Black regions are anti-mask.





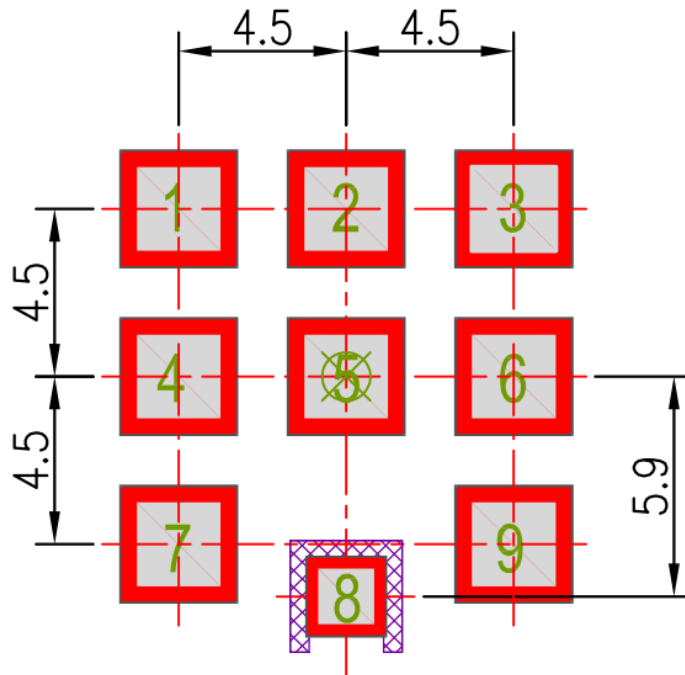

NOTE:

- | | |
|------------------------|---|
| 1. Ag Plated area |  |
| 2. Solder Mask area |  |
| 3. Copper area |  |
| 4. Paste area |  |
| 5. Copper Keepout Area |  |
6. Copper keepout should extend through all PCB layers.
 7. Any vias in pads should be either filled or tented to prevent solder from wicking away from the pad during reflow.
 8. The dimension tolerances should follow standard PCB manufacturing guidelines

7.4. Composite Diagram (unit: mm)



NOTE:

1. Ag Plated area 
2. Solder Mask area 
3. Copper area 
4. Paste area 
5. Copper Keepout Area 
6. Copper keepout should extend through all PCB layers.
7. Any vias in pads should be either filled or tented to prevent solder from wicking away from the pad during reflow.
8. The dimension tolerances should follow standard PCB manufacturing guidelines

8. Recommended Reflow Soldering Profile

SGGP.12A can be assembled following Pb-free assembly. According to the Standard IPC/JEDEC J-STD-020C, the temperature profile suggested is as follows:

Phase	Profile Features	Pb-Free Assembly (SnAgCu)
PREHEAT	Temperature Min(T_{smin}) Temperature Max(T_{smax}) Time(ts) from (T_{smin} to T_{smax})	150°C 200°C 60-120 seconds
RAMP-UP	Avg. Ramp-up Rate (T_{smax} to TP)	3°C/second(max)
REFLOW	Temperature(T_L) Total Time above T_L (t_L)	217°C 30-100 seconds
PEAK	Temperature(T_P) Time(t_p)	260°C 2-5 seconds
RAMP-DOWN	Rate	3°C/second(max)
Time from 25°C to Peak Temperature		8 minutes max.
Composition of solder paste		96.5Sn/3Ag/0.5Cu
Solder Paste Model		SHENMAO PF606-P26

The graphic shows temperature profile for component assembly process in reflow ovens

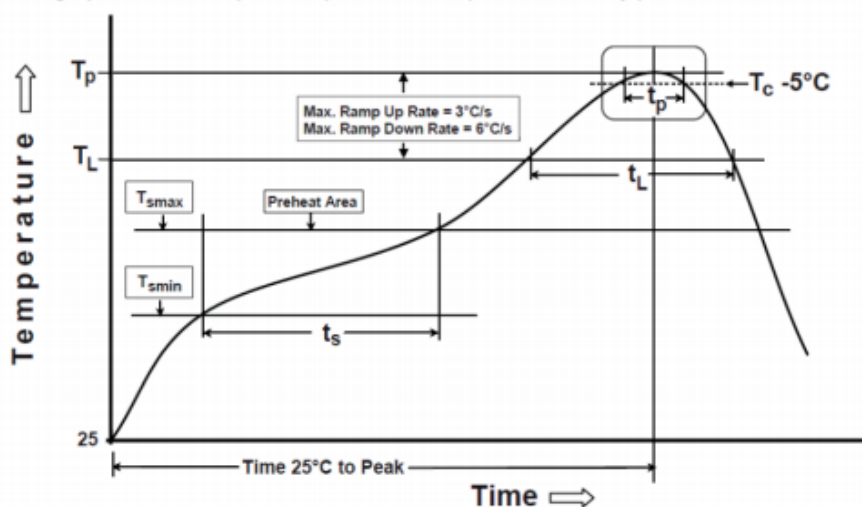

Soldering Iron condition: Soldering iron temperature $270^{\circ}\text{C} \pm 10^{\circ}\text{C}$.

Apply preheating at 120°C for 2-3 minutes. Finish soldering for each terminal within 3 seconds, if soldering iron temperature over $270^{\circ}\text{C} \pm 10^{\circ}\text{C}$ or 3 seconds, it will make cause component surface peeling or damage.

9. Packaging

9.1. Inner Tray

500 pc SGGP.12.4.A.02 per reel
 Dimensions - Ø330*38mm
 Weight - 2.0Kg

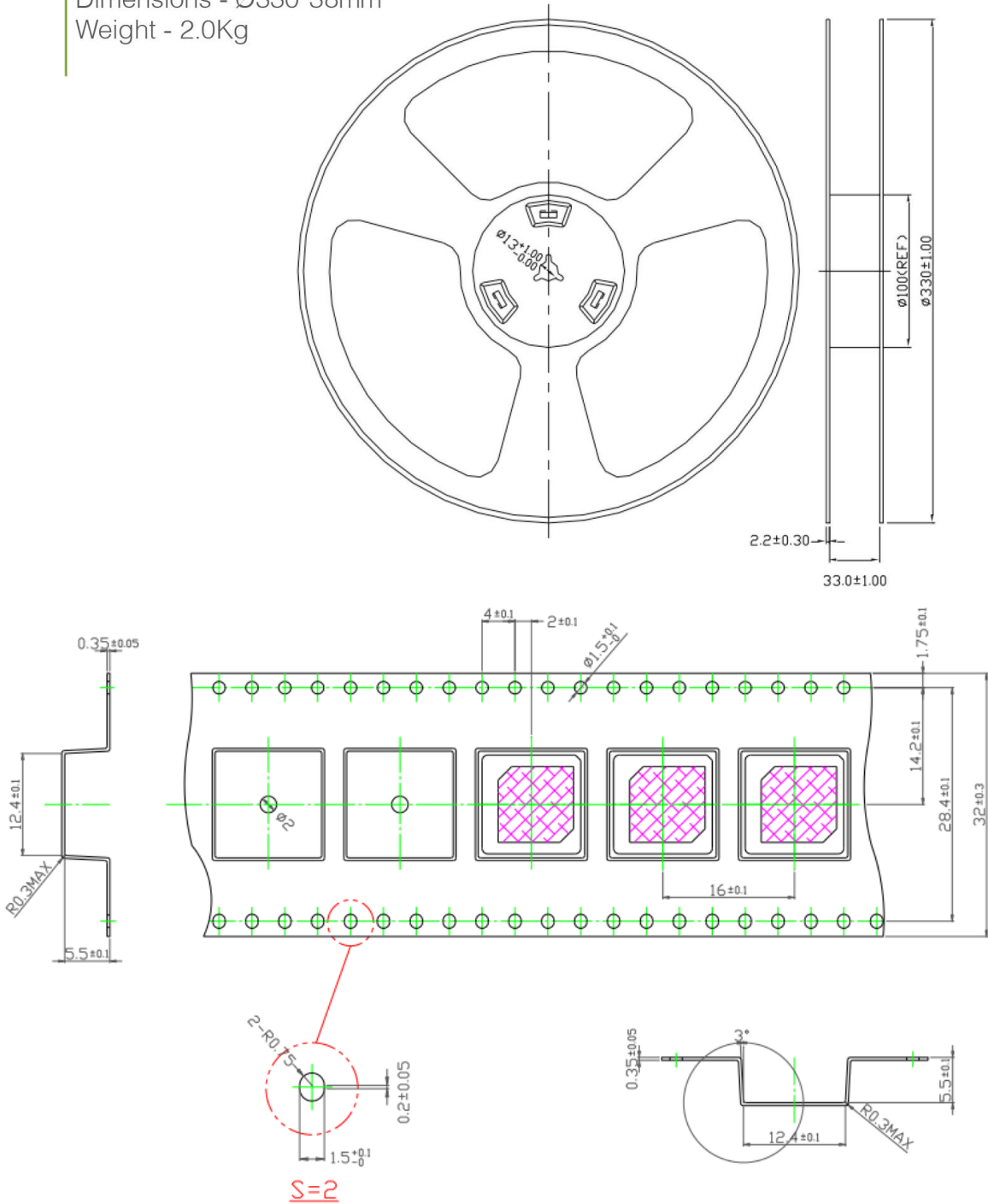

1 pc reel in small inner box
Dimensions - 350*340*70mm
Weight - 2.3Kg

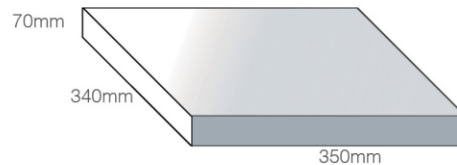

4 Reels / 2000 pcs in one carton
Carton Dimensions - 370*370*300mm
Weight - 9.7Kg

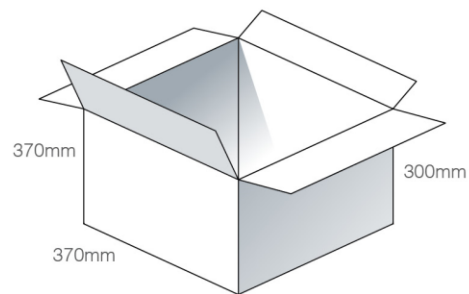

Pallet Dimensions 1100*1100*1270mm
36 Cartons per Pallet
9 Cartons per layer
4 Layers

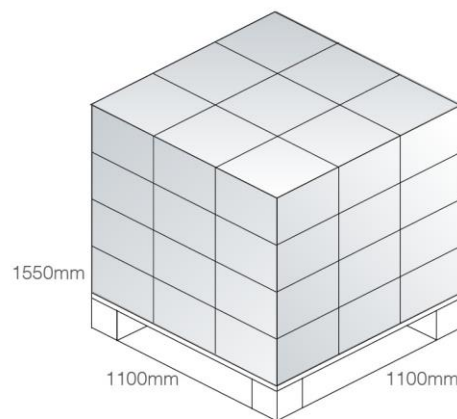

Taoglas makes no warranties based on the accuracy or completeness of the contents of this document and reserves the right to make changes to specifications and product descriptions at any time without notice. Taoglas reserves all rights to this document and the information contained herein.

Reproduction, use or disclosure to third parties without express permission is strictly prohibited.

Copyright © Taoglas Ltd.