



# SIRP3015X12-J5

## SMD Type 880nm Infrared Emitter

### Features

- Small double-end package
- Viewing Angle =  $\pm 42.5^\circ$
- High reliability
- Good spectral matching to Si photo detector
- RoHS compliance

### Applications

- Infrared sensor

### Description

The SIRP3015X12-J5 is a GaAlAs infrared LED housed in a miniature SMD package. The device has a peak wavelength of 880nm LED spectrally matched with phototransistor or photodiode.

### Package Outline

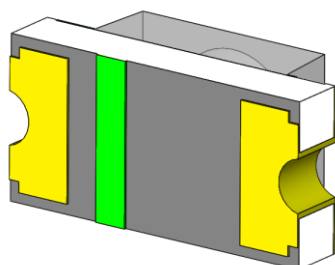
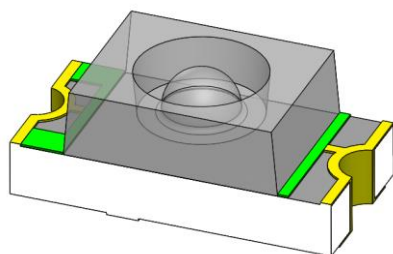

Anode

Cathode

### Schematic

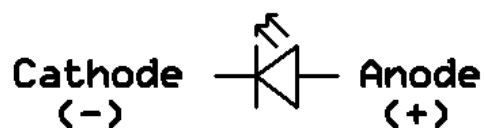

**Absolute Maximum Rating at 25°C**

Symbol	Parameters	Ratings	Units	Notes
I <sub>F</sub>	Continuous Forward Current	70	mA	
I <sub>FP</sub>	Peak Forward Current	0.7	A	1
V <sub>R</sub>	Reverse Voltage	5	V	
T <sub>opr</sub>	Operating Temperature	-40 ~ +85	°C	
T <sub>stg</sub>	Storage Temperature	-40 ~ +100	°C	
T <sub>sol</sub>	Soldering Temperature	260	°C	2
P <sub>D</sub>	Power Dissipation at(or below) 25°C Free Air Temperature	140	mW	

**Electro-Optical Characteristics** *TA = 25°C (unless otherwise specified)***Optical Characteristics**

Symbol	Parameters	Test Conditions	Min	Typ	Max	Units	Notes
I <sub>e</sub>	Radiant Intensity	I <sub>F</sub> =20mA	2.5	5.0	-	mW/sr	
		I <sub>F</sub> =70mA	-	17	-		
λ <sub>p</sub>	Peak Wavelength	I <sub>F</sub> =20mA	-	880	-	nm	
Δλ	Spectral Bandwidth	I <sub>F</sub> =20mA	-	30	-	nm	
θ <sub>1/2</sub>	Angle of Half Intensity	I <sub>F</sub> =20mA	-	±42.5	-	deg	

**Electrical Characteristics**

Symbol	Parameters	Test Conditions	Min	Typ	Max	Units	Notes
V <sub>F</sub>	Forward Voltage	I <sub>F</sub> =20mA	1.20	1.35	1.7	V	
		I <sub>F</sub> =70mA	1.30	1.47	2.0		
I <sub>R</sub>	Reverse Current	V <sub>R</sub> =5V	-	-	10	μA	

**Notes:**

1. I<sub>FP</sub> Conditions--Pulse Width ≤ 100μs and Duty ≤ 1%.
2. Soldering time ≤ 5 seconds.



### Typical Characteristic Curves

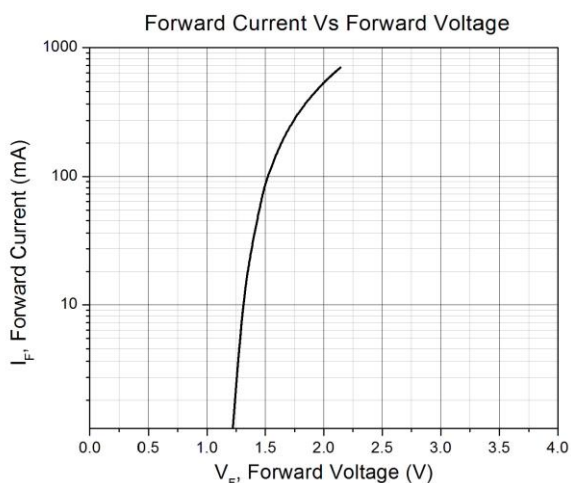

Figure 1

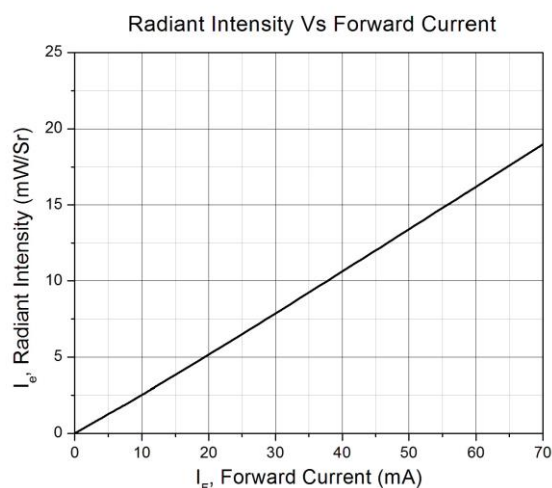

Figure 2

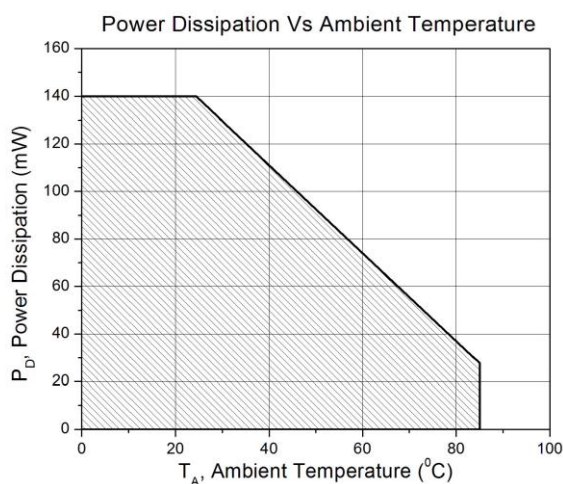

Figure 3

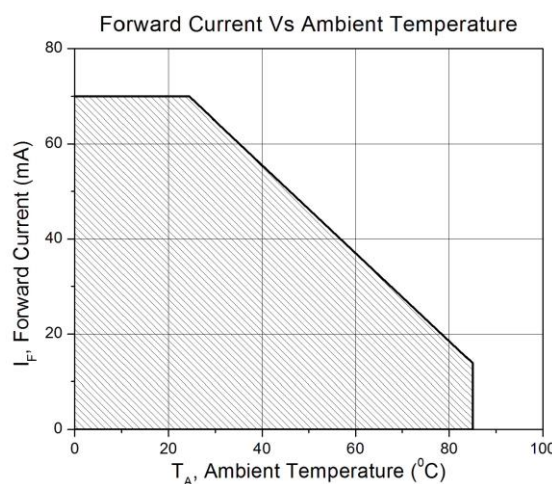

Figure 4

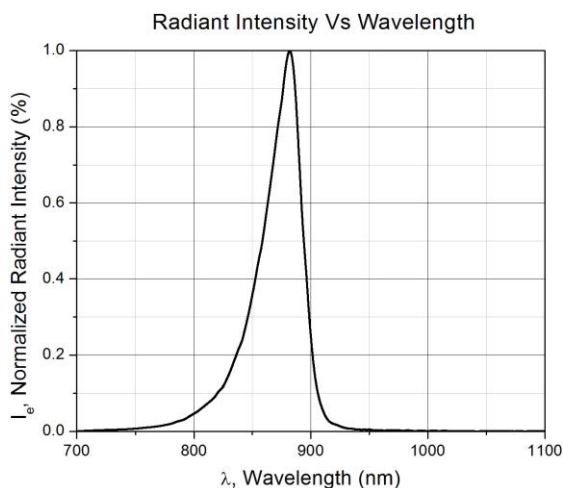
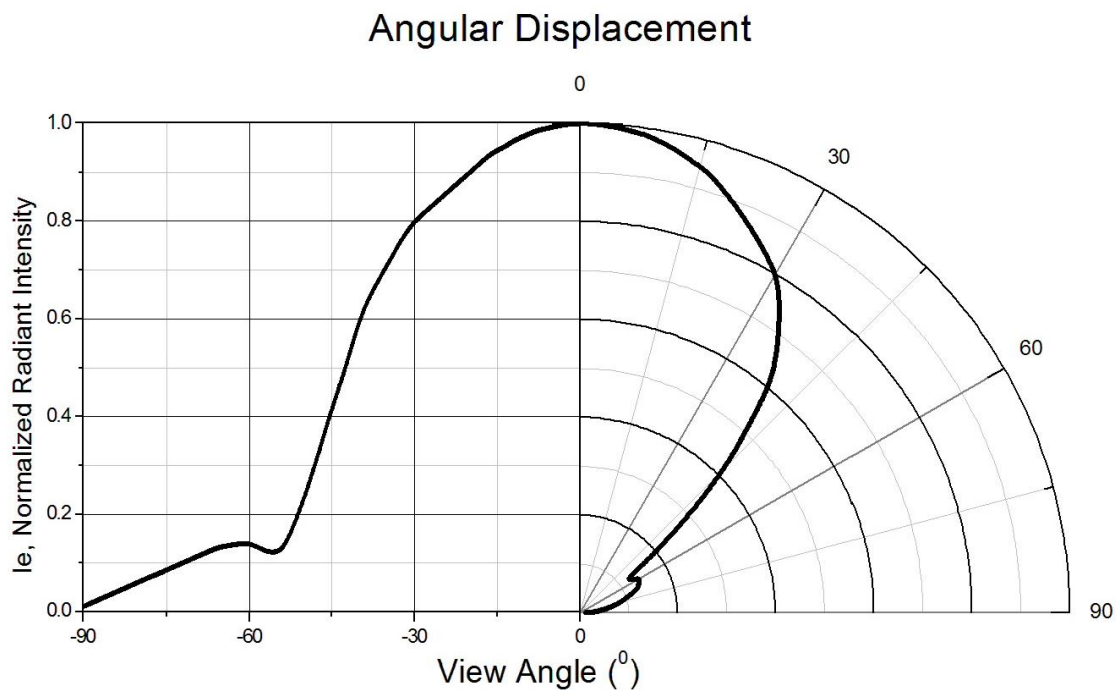

Figure 5



Typical Characteristic Curves





**Package Dimension** *All dimensions are in mm, unless otherwise stated*

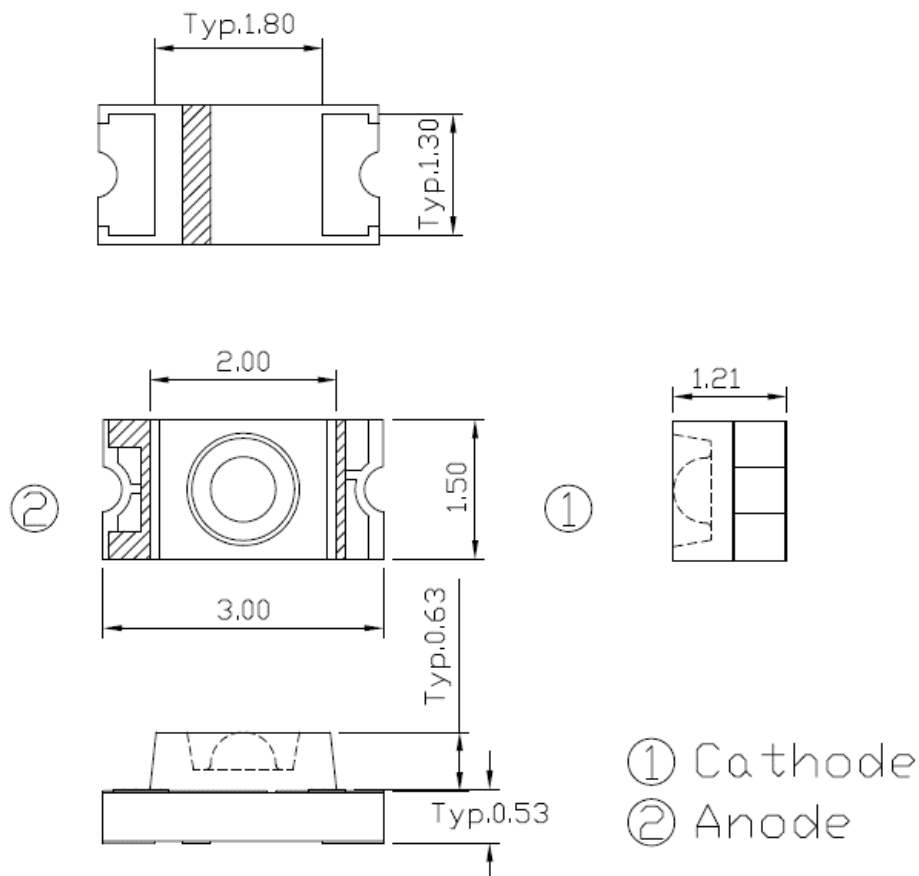

**Recommended Soldering Mask** *All dimensions are in mm, unless otherwise stated*

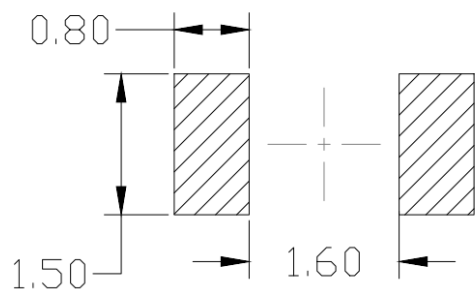

**Ordering Information**

Part Number	Description	Quantity
SIRP3015X12-J5	Tape & Reel	3000 pcs



SIRP3015X12-J5

SMD Type 880nm Infrared Emitter

**Reel Dimension** *All dimensions are in mm, unless otherwise stated*

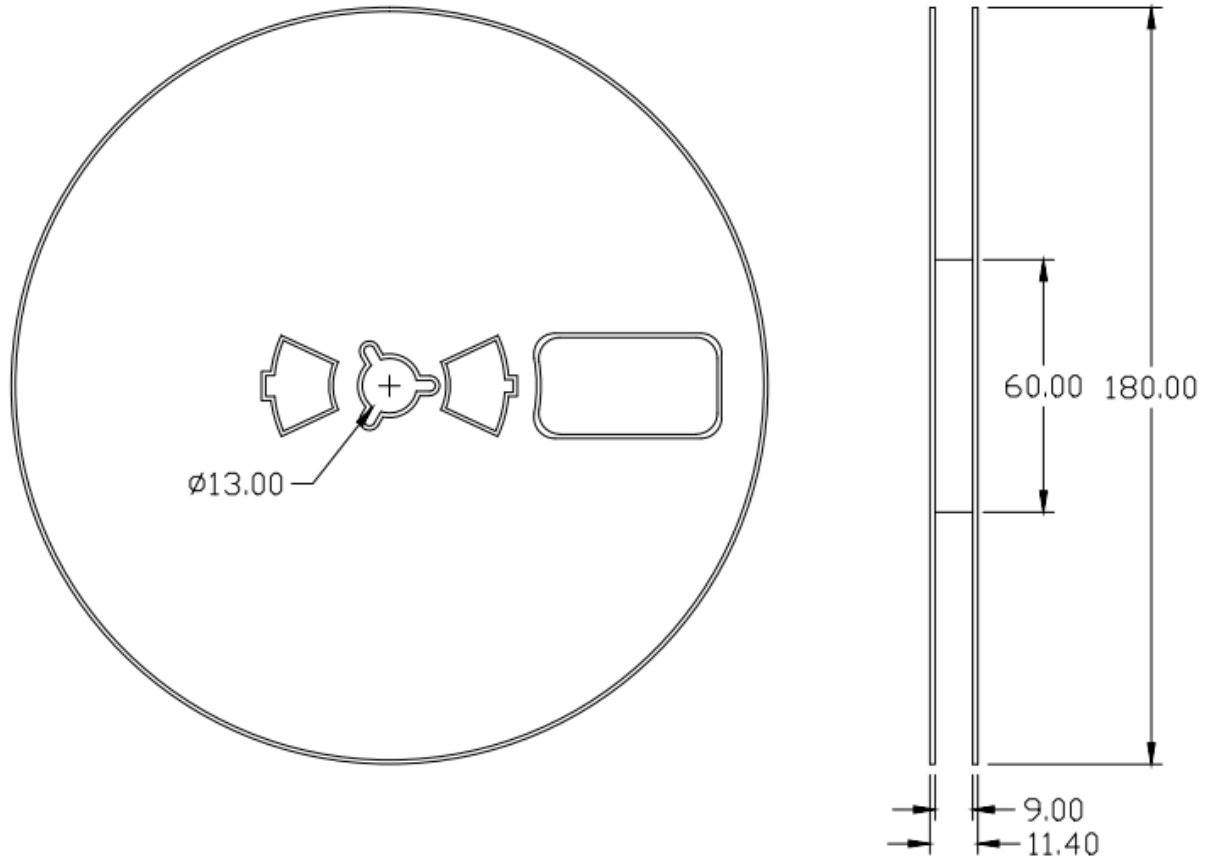

**Tape Dimension** *All dimensions are in mm, unless otherwise stated*

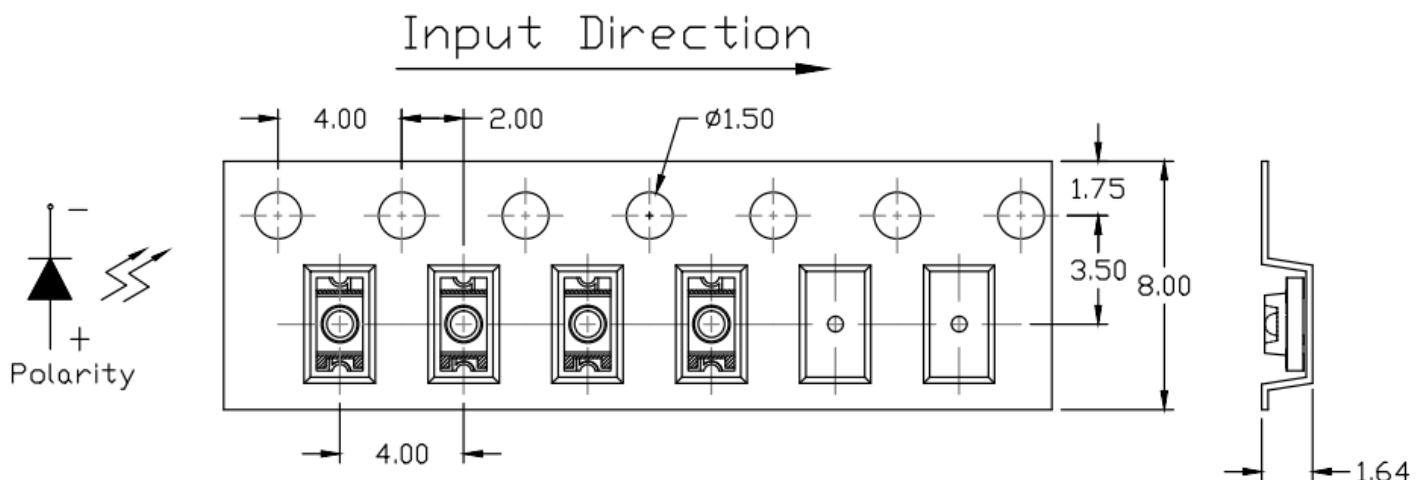



Reflow Profile

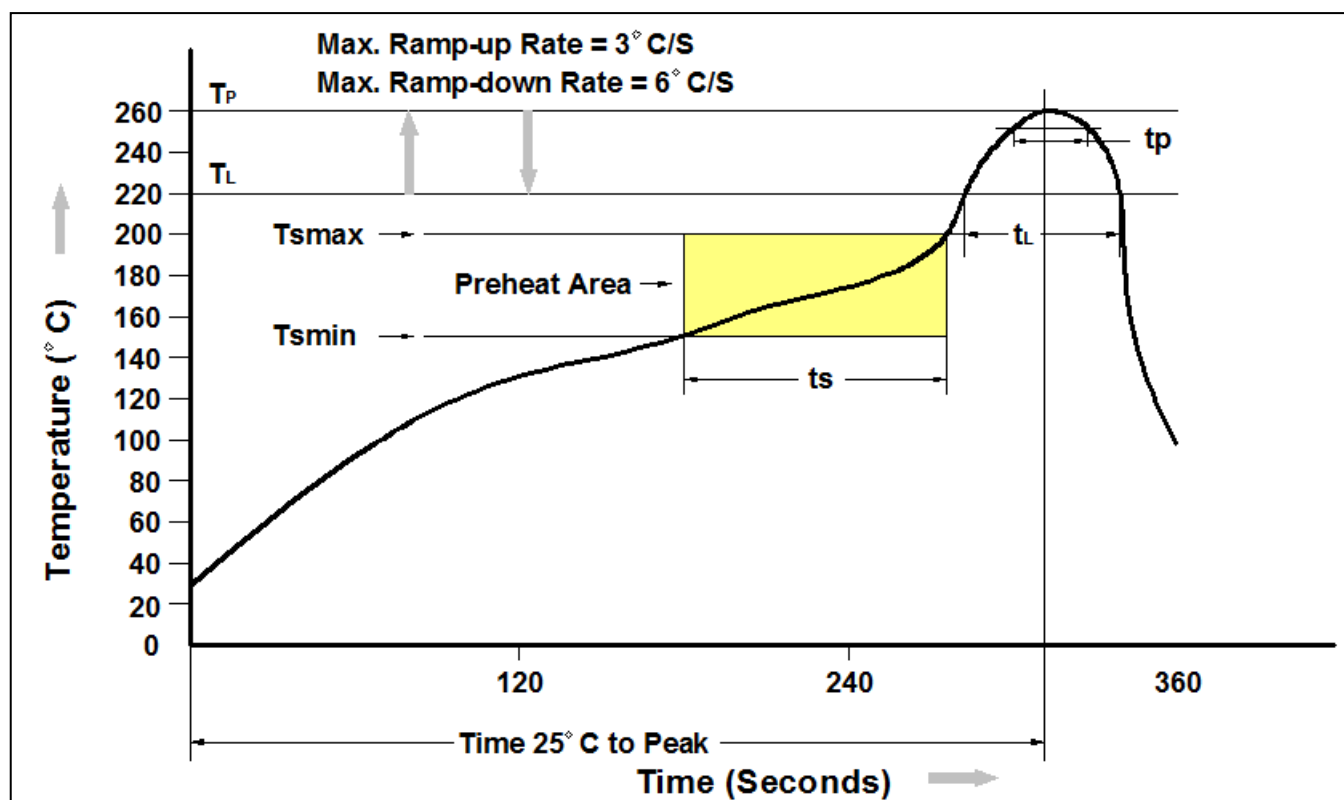

Profile Feature	Pb-Free Assembly Profile
Temperature Min. (Tsmín)	150°C
Temperature Max. (Tsmáx)	200°C
Time (ts) from (Tsmín to Tsmáx)	60-120 seconds
Ramp-up Rate (tl to tp)	3°C/second max.
Liquidous Temperature (Tl)	217°C
Time (tl) Maintained Above (Tl)	60 – 150 seconds
Peak Body Package Temperature	260°C +0°C / -5°C
Time (tp) within 5°C of 260°C	30 seconds
Ramp-down Rate (Tp to Tl)	6°C/second max
Time 25°C to Peak Temperature	8 minutes max.



## DISCLAIMER

CT MICRO RESERVES THE RIGHT TO MAKE CHANGES WITHOUT FURTHER NOTICE TO ANY PRODUCTS HEREIN TO IMPROVE RELIABILITY, FUNCTION OR DESIGN. CT MICRO DOES NOT ASSUME ANY LIABILITY ARISING OUT OF THE APPLICATION OR USE OF ANY PRODUCT OR CIRCUIT DESCRIBED HEREIN; NEITHER DOES IT CONVEY ANY LICENSE UNDER ITS PATENT RIGHTS, NOR THE RIGHTS OF OTHERS.

---

CT MICRO ARE NOT AUTHORIZED FOR USE AS CRITICAL COMPONENTS IN LIFE SUPPORT DEVICES OR SYSTEMS WITHOUT EXPRESS WRITTEN APPROVAL OF CT MICRO INTERNATIONAL CORPORATION.

- 1. Life support devices or systems are devices or systems which, (a) are intended for surgical implant into the body, or (b) support or sustain life, or (c) whose failure to perform when properly used in accordance with instruction for use provided in the labelling, can be reasonably expected to result in significant injury to the user.*
- 2. A critical component is any component of a life support device or system whose failure to perform can be reasonably expected to cause the failure of the life support device or system, or to affect its safety or effectiveness.*