

Features

- Batch process design, excellent power dissipation offers better reverse leakage current and thermal resistance.
- Low profile surface mounted application in order to optimize board space.
- Low power loss, high efficiency.
- High current capability, low forward voltage drop.
- High surge capability.
- Guardring for overvoltage protection.
- Ultra high-speed switching.
- Silicon epitaxial planar chip, metal silicon junction.
- **Moisture Sensitivity Level 1**

Package outline

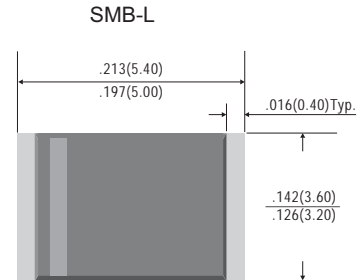

Mechanical data

- Epoxy: UL94-V0 rated flame retardant
- Case : Molded plastic, SMB-L
- Terminals : Solder plated, solderable per MIL-STD-750, Method 2026
- Polarity : Indicated by cathode band
- Mounting Position : Any
- Weight : Approximated 0.09 gram

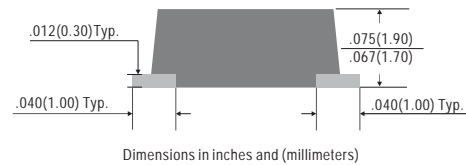

Dimensions in inches and (millimeters)

Maximum ratings and Electrical Characteristics (AT $T_A=25^{\circ}\text{C}$ unless otherwise noted)

PARAMETER	CONDITIONS	Symbol	MIN.	TYP.	MAX.	UNIT
Forward rectified current	See Fig.2	I_o			3.0	A
Forward surge current	8.3ms single half sine-wave superimposed on rate load (JEDEC methode)	I_{FSM}			80	A
Reverse current	$V_R = V_{RRM}$ $T_J = 25^{\circ}\text{C}$	I_R			1.0	mA
Diode junction capacitance	f=1MHz and applied 4V DC reverse voltage	C_j		300		pF
Storage temperature		T_{STG}	-55		+150	$^{\circ}\text{C}$

SYMBOLS	V_{RRM}^{*1} (V)	V_{RMS}^{*2} (V)	V_R^{*3} (V)	V_F^{*4} (V)	Operating temperature T_{Jr} ($^{\circ}\text{C}$)
SL32-BL	20	14	20	0.38	-55 to +100
SL34-BL	40	28	40	0.40	

*1 Repetitive peak reverse voltage

*2 RMS voltage

*3 Continuous reverse voltage

*4 Maximum forward voltage@ $I_F=3.0\text{A}$



Rating and characteristic curves

FIG.1-TYPICAL FORWARD CHARACTERISTICS

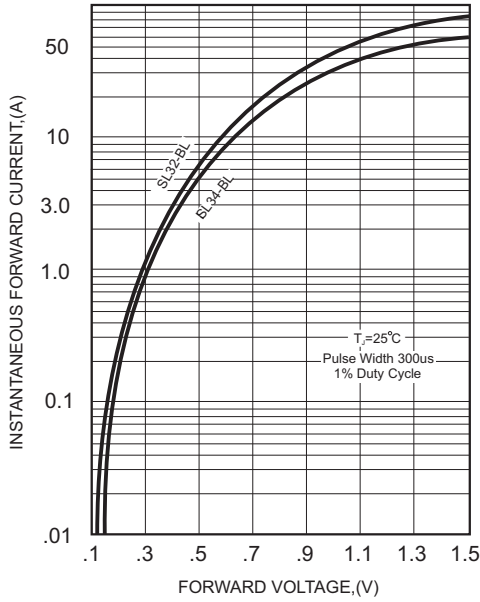

FIG.2-TYPICAL FORWARD CURRENT DERATING CURVE

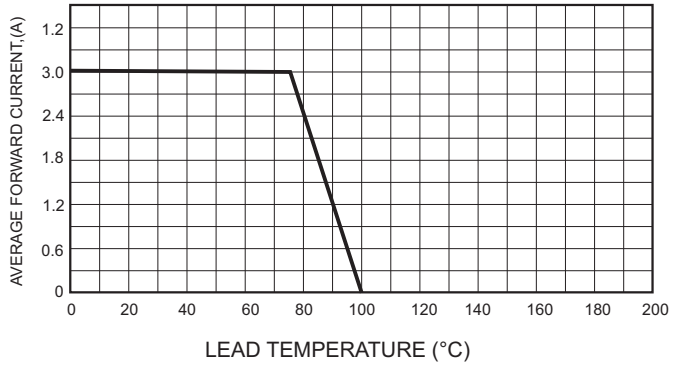

FIG.4-MAXIMUM NON-REPETITIVE FORWARD SURGE CURRENT

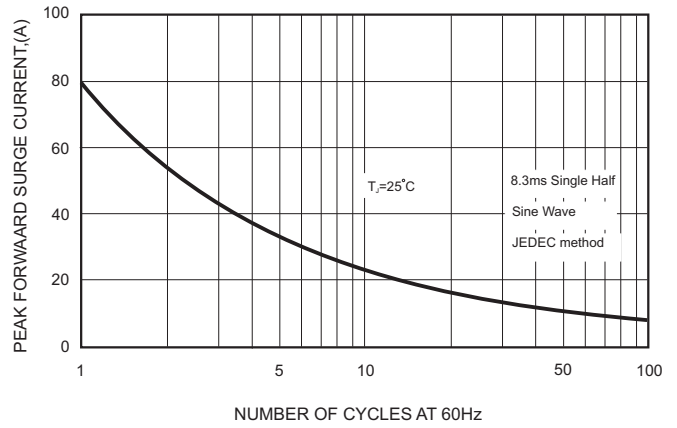

FIG.3 - TYPICAL REVERSE CHARACTERISTICS

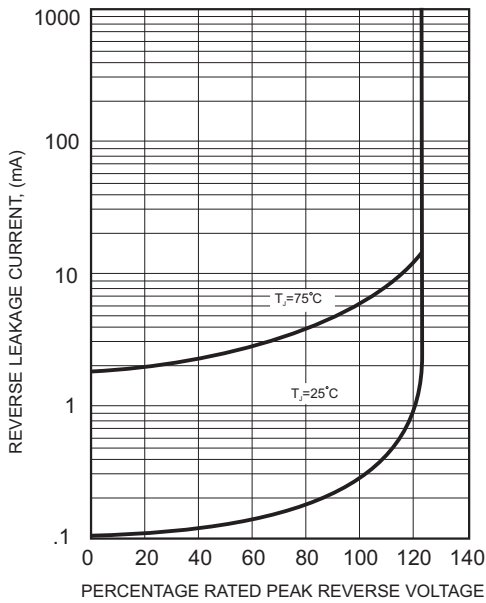
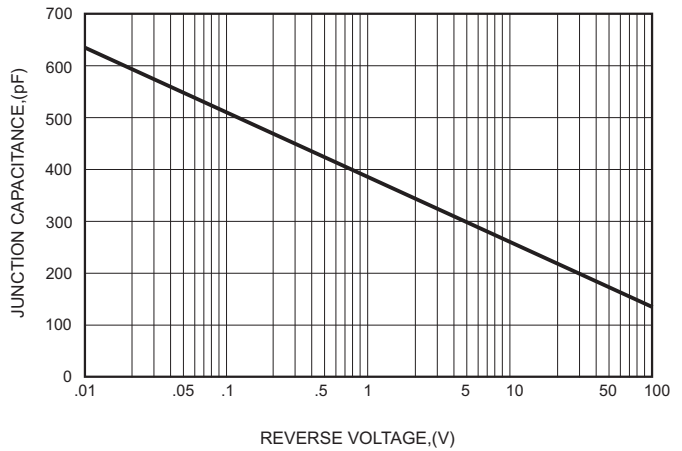



FIG.5-TYPICAL JUNCTION CAPACITANCE



Pinning information

Pin	Simplified outline	Symbol
Pin1 cathode Pin2 anode		

Reel packing

PACKAGE	REEL SIZE	REEL (pcs)	COMPONENT SPACING (m/m)	BOX (pcs)	INNER BOX (m/m)	REEL DIA, (m/m)	CARTON SIZE (m/m)	CARTON (pcs)	APPROX. GROSS WEIGHT (kg)
SMB-L	13"	4,000	8.0	8,000	337*337*37	330	350*330*360	64,000	16.9

Marking

Type number	Marking code
SL32-BŠĚ/P	SL32
SL34-BŠĚ/P	SL34

Note: BL: Package code, SMB-L
-T: Taping Reel

Pb-Free package is available

RoHS product for packing code suffix "G"

Halogen free product for packing code suffix "H"

Suggested solder pad layout

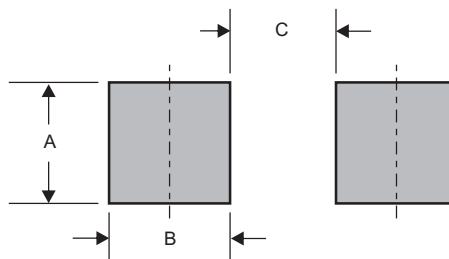

Dimensions in inches and (millimeters)

PACKAGE	A	B	C
SMBŠ	0.142 (3.60)	0.059 (1.50)	0.118 (3.00)



Packing information

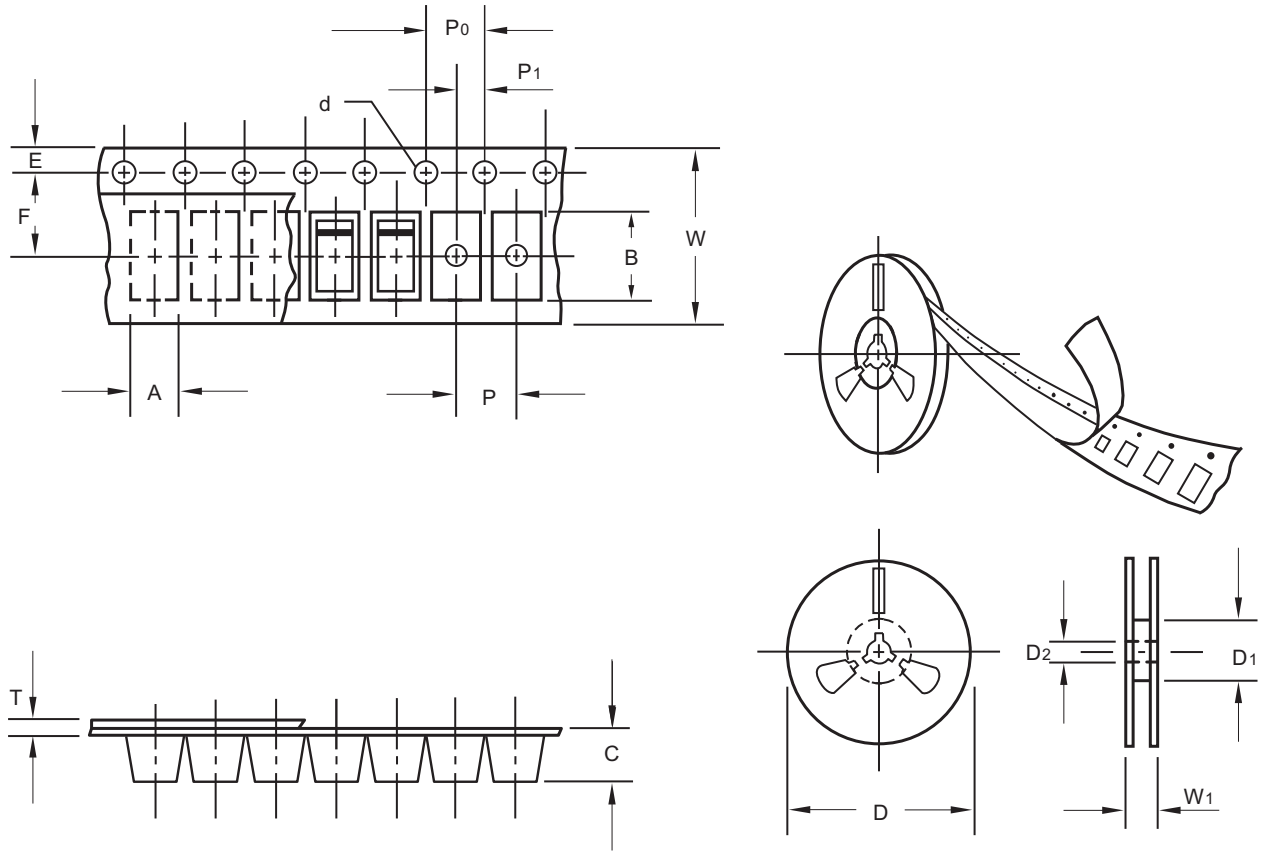

unit:mm

Item	Symbol	Tolerance	SMBES
Carrier width	A	0.1	3.81
Carrier length	B	0.1	5.74
Carrier depth	C	0.1	2.24
Sprocket hole	d	0.1	1.50
13" Reel outside diameter	D	2.0	330.00
13" Reel inner diameter	D1	min	50.00
7" Reel outside diameter	D	2.0	178.00
7" Reel inner diameter	D1	min	62.00
Feed hole diameter	D2	0.5	13.00
Sprocket hole position	E	0.1	1.75
Punch hole position	F	0.1	5.50
Punch hole pitch	P	0.1	8.00
Sprocket hole pitch	P0	0.1	4.00
Embossment center	P1	0.1	2.00
Overall tape thickness	T	0.1	0.23
Tape width	W	0.3	12.00
Reel width	W1	1.0	18.00

Note: Devices are packed in accordance with EIA standard RS-481-A and specifications listed above.