

SOT-323 Plastic-Encapsulate Diode

BAV99W

SWITCHING DIODE

FEATURES

- For high-speed switching applications
- Connected in series

MARKING: KJG

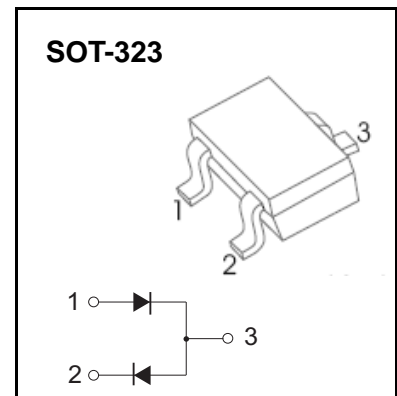

Solid dot = Green molding compound device,
if none, the normal device

Maximum Ratings @Ta=25°C

Parameter	Symbol	Limit	Unit
Reverse Voltage	V_R	75	V
Forward Current	I_F	100	mA
Non-Repetitive Peak Forward Surge Current @t=8.3ms	I_{FSM}	2.0	A
Power Dissipation	P_D	100	mW
Thermal Resistance Junction to Ambient	$R_{\theta JA}$	625	°C/W
Junction Temperature	T_J	150	°C
Storage Temperature range	T_{STG}	-55~+150	°C

ELECTRICAL CHARACTERISTICS (Ta=25°C unless otherwise specified)

Parameter	Symbol	Test conditions	Min	Max	Unit
Reverse breakdown voltage	$V_{(BR)}$	$I_R = 1 \mu A$	5		V
Reverse voltage leakage current	I_{R1}	$V_R = 75V$		2.5	μA
	I_{R2}	$V_R = 25V$		25	nA
Forward voltage	V_F	$I_F = 1mA$ $I_F = 10mA$ $I_F = 50mA$ $I_F = 150mA$		715 855 1000 1250	mV
Diode capacitance	C_D	$V_R = 0$ $f = 1MHz$		6	pF
Reverse recovery time	t_{rr}	$I_F = I_R = 10mA$ $I_{rr} = 0.1 \times I_R, R_L = 100\Omega$		4	ns

Typical Characteristics

Forward Characteristics

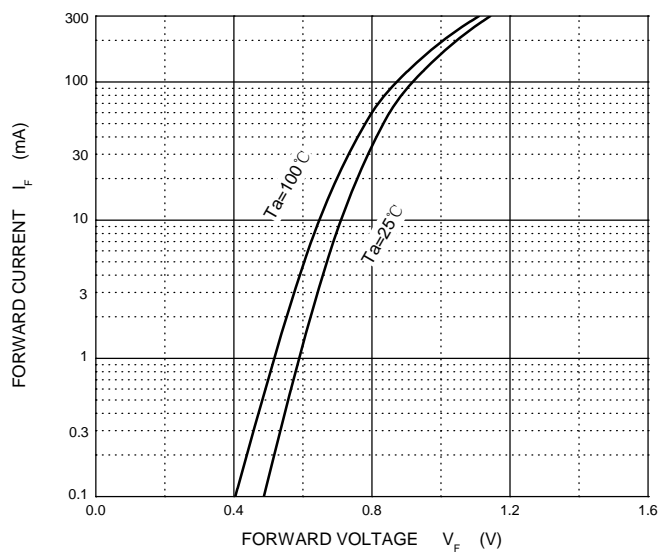

Reverse Characteristics

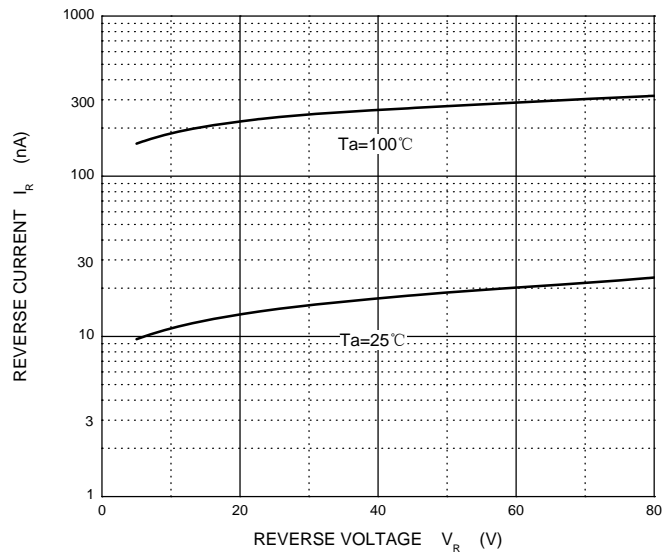

Capacitance Characteristics

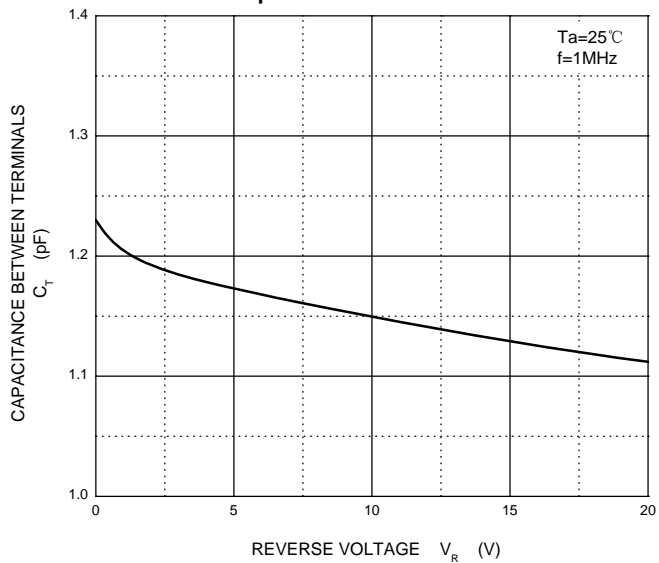

Power Derating Curve

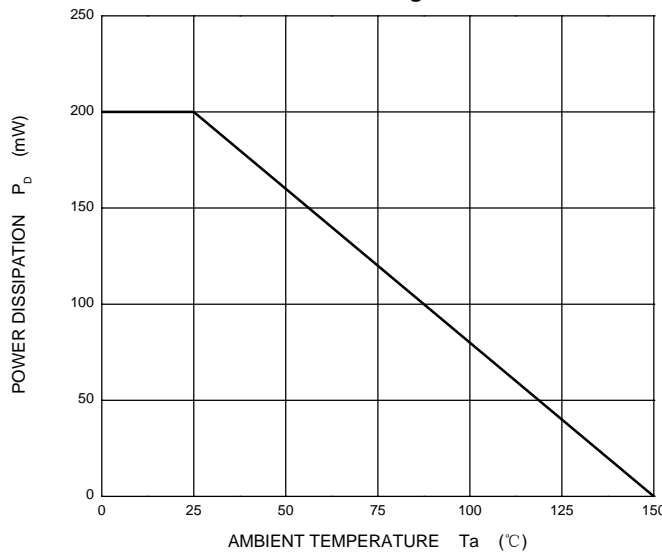

SOT-323 Package Outline Dimensions



Symbol	Dimensions In Millimeters		Dimensions In Inches	
	Min	Max	Min	Max
A	0.900	1.100	0.035	0.043
A1	0.000	0.100	0.000	0.004
A2	0.900	1.000	0.035	0.039
b	0.200	0.400	0.008	0.016
c	0.080	0.150	0.003	0.006
D	2.000	2.200	0.079	0.087
E	1.150	1.350	0.045	0.053
E1	2.150	2.450	0.085	0.096
e	0.650 TYP		0.026 TYP	
e1	1.200	1.400	0.047	0.055
L	0.525 REF		0.021 REF	
L1	0.260	0.460	0.010	0.018
theta	0°	8°	0°	8°

SOT-323 Suggested Pad Layout



Note:

1. Controlling dimension: in millimeters.
2. General tolerance: ± 0.05 mm.
3. The pad layout is for reference purposes only.

NOTICE

JCET reserve the right to make modifications, enhancements, improvements, corrections or other changes without further notice to any product herein. JCET does not assume any liability arising out of the application or use of any product described herein.

SOT-323 Tape and Reel

SOT-323 Embossed Carrier Tape

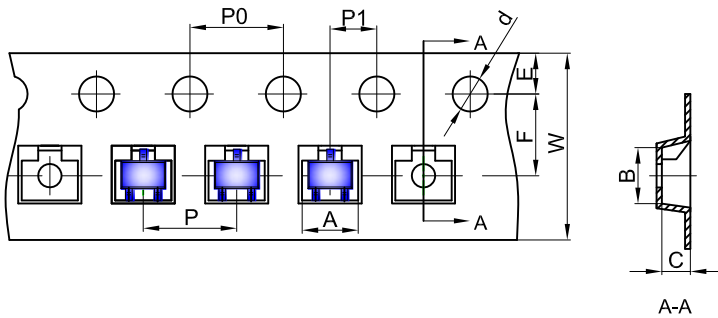

Packaging Description:
 SOT-323 parts are shipped in tape. The carrier tape is made from a dissipative (carbon filled) polycarbonate resin. The cover tape is a multilayer film (Heat Activated Adhesive in nature) primarily composed of polyester film, adhesive layer, sealant, and anti-static sprayed agent. These reeled parts in standard option are shipped with 3,000 units per 7" or 17.8cm diameter reel. The reels are clear in color and is made of polystyrene plastic (anti-static coated).

Dimensions are in millimeter										
Pkg type	A	B	C	d	E	F	P0	P	P1	W
SOT-323	2.25	2.55	1.19	Ø1.55	1.75	3.50	4.00	4.00	2.00	8.00

SOT-323 Tape Leader and Trailer

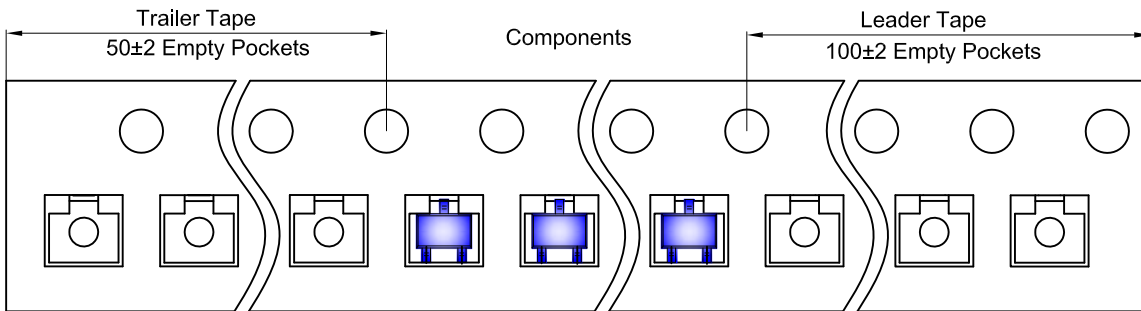

SOT-323 Reel

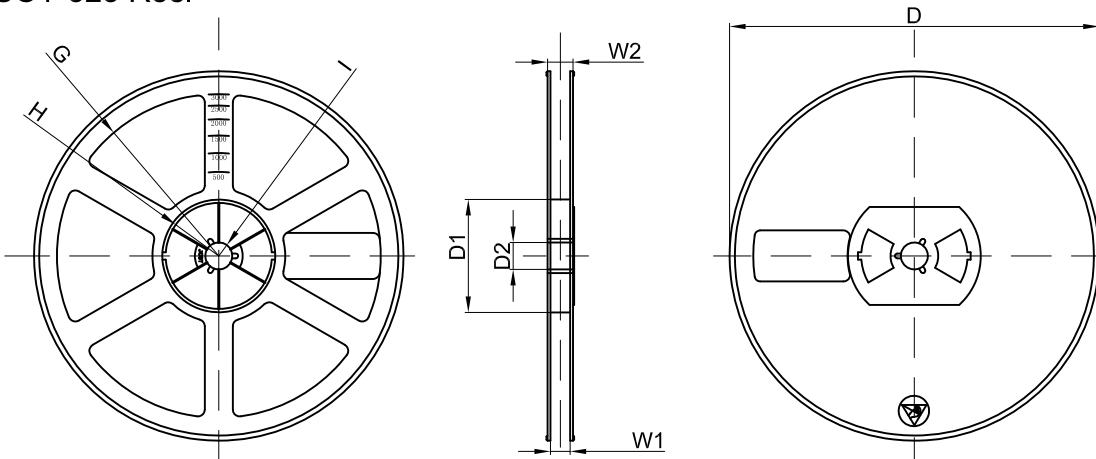

Dimensions are in millimeter								
Reel Option	D	D1	D2	G	H	I	W1	W2
7" Dia	Ø178.00	54.40	13.00	R78.00	R25.60	R6.50	9.50	12.30

REEL	Reel Size	Box	Box Size(mm)	Carton	Carton Size(mm)	G.W.(kg)
3000 pcs	7 inch	45,000 pcs	203×203×195	180,000 pcs	438×438×220	