

|    |    |     |     |    |
|----|----|-----|-----|----|
| 修改 | 记号 | 内 容 | 修改者 | 日期 |
|    |    |     |     |    |
|    |    |     |     |    |

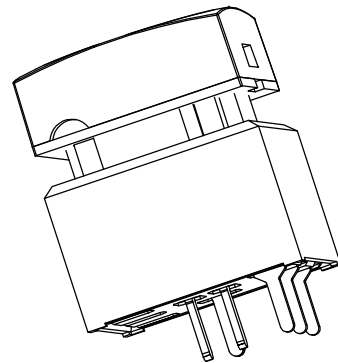

### SWSCHEMATIC

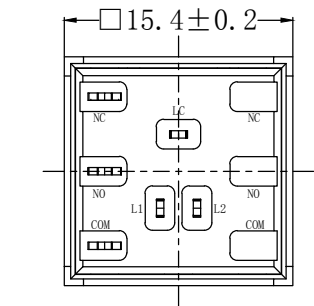
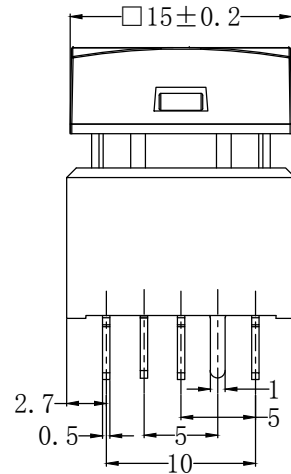
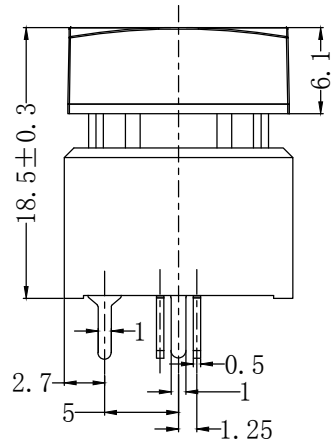
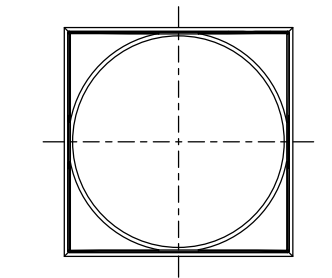
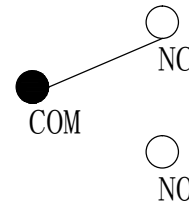

### LEDSCHEMATIC

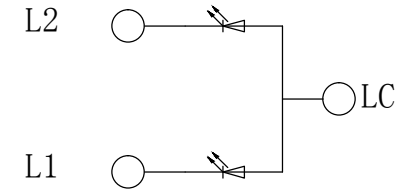

### P. C. B. LAYOUT

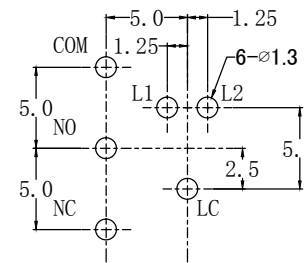

| Color  | VR    | IF   | Recommended Operating Current | VF   |      |
|--------|-------|------|-------------------------------|------|------|
|        |       |      |                               | Min  | Max  |
| Red    | DC 5V | 20mA | 20mA                          | 1.9V | 2.0V |
| Green  | DC 5V | 20mA | 20mA                          | 3.0V | 3.2V |
| Yellow | DC 5V | 20mA | 20mA                          | 1.9V | 2.2V |
| Blue   | DC 5V | 20mA | 20mA                          | 2.9V | 3.1V |
| White  | DC 5V | 20mA | 20mA                          | 3.0V | 3.2V |
| Orange | DC 5V | 20mA | 20mA                          | 1.9V | 2.1V |

For the specification about the other LEDs, please contact with sales department

1. NONL-LOCKTYPE.
2. RATING:0.5A, 100VAC;0.2A, 250VAC;0.5A, 25VDC.
3. CONTACTRESISTANCE:SILVERCONTACT:50M ΩMAX.
4. INSULATIONRESISTANCE:500VDC, 100M ΩMIN .
5. OPERATING TEMPERATURE:-40° C~85° C.
6. OPERATING FORCE:200 ± 100gf.
7. OPERATINGLIFE:200, 000CYCLES.
8. ITISRECOMMENDEDTHATTHENUMBEROFTIMESTOPULL OUTTHECAPSHOULDNOTEXCEED3

本公司智慧财产，未经同意不得复制  
Without permission, copying is strictly prohibited. Chau-hua

ALLDIMENSIONS ARE IN MILLIMETERS, GENERAL TOLERANCES MAX. ± 0.20mm.

|    |     |      |    |    |            |
|----|-----|------|----|----|------------|
| 制图 | HH  | 比例   |    | 日期 | 2020.09.25 |
| 设计 | HH  | 单位   | MM | 材质 |            |
| 校对 | LZY | 全周倒角 |    | 数量 |            |
| 审核 | MW  | 视图   |    | 处理 |            |



昭华集团(香港)有限公司  
CHAU-HUA GROUP (HONGKONG) CO., LIMITED

|    |                    |
|----|--------------------|
| 图号 | C3026A-3M-W-RG-T-C |
| 图名 | C3026A-3M-W-RG-T-C |