



1.2V/1.32V 1A LOW DROPOUT FIXED-MODE REGULATOR

FEATURES

- 1.5V Maximum Dropout at Full Load Current
- Fast Transient Response
- Output Current Limiting
- Built-in Thermal Shutdown
- Needs Only 1uF Capacitor for Stability
- Good Noise Rejection
- 3-Terminal Fixed 1.2V/1.32V
- Low ESR Ceramic Capacitor for Output Stability
- Packages : SOT-223, TO-252, SOT-89(R-type) & SOT-223(R-type)
- RoHS Compliant

DESCRIPTION

APE891X is a low dropout fixed-mode regulator with minimum of 1A output current capability. The product is specifically designed to provide well-regulated supply for low voltage IC applications such as high-speed bus termination and low current 1.2V/1.32V logic supply.
APE891X is guaranteed to have lower than 1.5V dropout at full load current making it ideal to provide well-regulated outputs of 1.2/1.32 with 3V to 6V input supply.

APPLICATIONS

- PC Peripheral
- Communication
- LCD Modules

TYPICAL APPLICATION

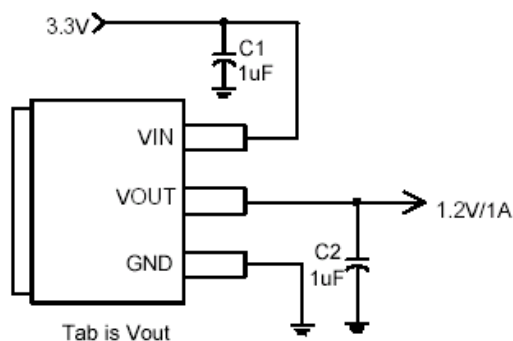

Figure 1. 1.2V fixed output

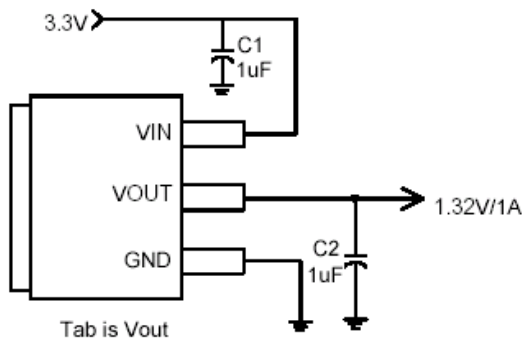

Figure 2. 1.32V fixed output

PACKAGE ORDERING INFORMATION

APE891XX	
Output Voltage	Package Type
2 : 1.2V Fixed	G : SOT-89-3L
3 : 1.32V Fixed	GR : SOT-89-3L
	H : TO-252-3L
	K : SOT-223-3L
	KR : SOT-223-3L

ABSOLUTE MAXIMUM RATINGS

V _{IN} Supply Voltage(V _{IN})	-0.3 to 6 V
Power Dissipation(P _D)	Internal Limited
Storage Temperature Range(T _{ST})	-65 to 150°C
Operating Temperature Range(T _{OP})	0 to 150°C
Thermal Resistance from Junction to Case(R _{thJC})	
	SOT-89 100°C/W
	SOT-223 15°C/W
	SOT-252 10°C/W
Thermal Resistance from Junction to Ambient(R _{thJA})	
	SOT-89 300°C/W
	SOT-223 117°C/W
	SOT-252 92°C/W

PACKAGE INFORMATION

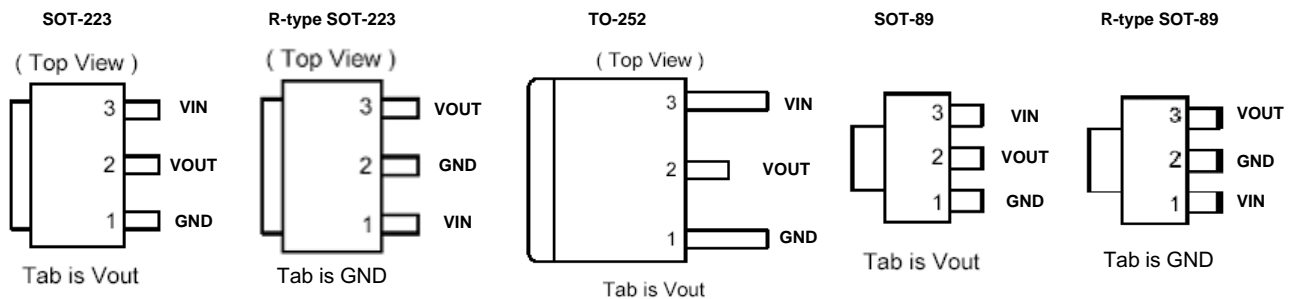

ELECTRICAL SPECIFICATIONS (Under Operating Conditions)

Parameter	SYM	TEST CONDITION	MIN	TYP	MAX	UNITS
Reference Voltage	V _{FB}	T _J =25°C, V _{IN} -V _{OUT} =1.5V, I _O =10mA	1.176	1.200	1.224	V
Output Voltage	V _{OUT}	APE8912 I _{OUT} =10mA, T _J =25°C	1.176	1.200	1.224	V
		APE8913 3V ≤ V _{IN} ≤ 6V	1.294	1.320	1.346	V
Line Regulation	V _{LINE}	T _J =25°C, V _{OUT} +1.5V < V _{IN} < 6V, I _O =10mA,	-	-	0.2	%
Load Regulation	V _{LOAD}	V _{adj} =10mA < I _O < 1A, (Note1,2) T _J =25°C, V _{IN} =3.3V,	-	-	1	%
Dropout Voltage (V _{IN} -V _{OUT})	V _{DROP}	I _{OUT} =1A, ΔV _{OUT} =1%V _{OUT}	-	1.4	1.5	V
Current Limit	I _{LIM}	APE8912/3 V _{IN} =3.3V	1.1	-	-	A
Minimum Load Current		0°C ≤ T _J ≤ 125°C	-	3	5	mA
Thermal Rejection		T _A =25°C, 30ms pulse	-	0.17	0.25	°C
Ripple Rejection		f=120Hz, C _{OUT} =25uF Tantalum, I _{OUT} =1A	-	60	70	db
		V _{IN} =V _{OUT} +3V				
Temperature Stability		I _O =10mA	-	0.5	-	%

Note1. See thermal regulation specifications for changes in output voltage due to heating effects. Line and load regulation are measured at a constant junction temperature by low duty cycle pulse testing.

Note2. Line and load regulation are guaranteed up to the maximum power dissipation of 15W. Power dissipation is determined by the difference between input and output differential and the output current. Guaranteed maximum power dissipation will not be available over the full input/output range.

Note3. Quiescent current is defined as the minimum output current required in maintaining regulation.



■ Typical Performance Characteristics

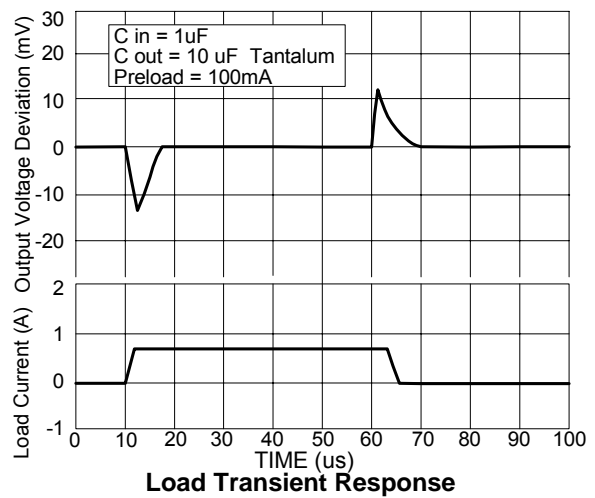
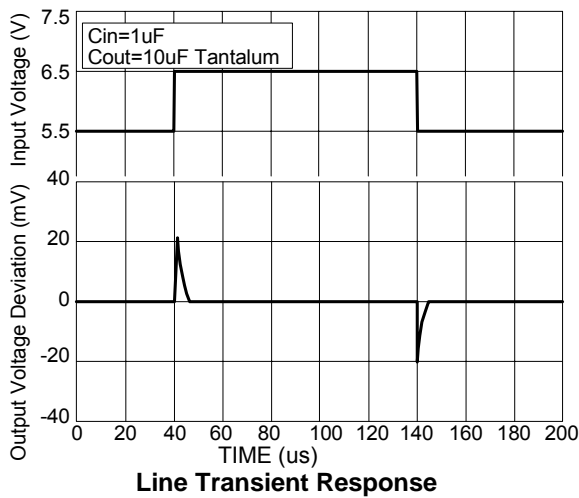
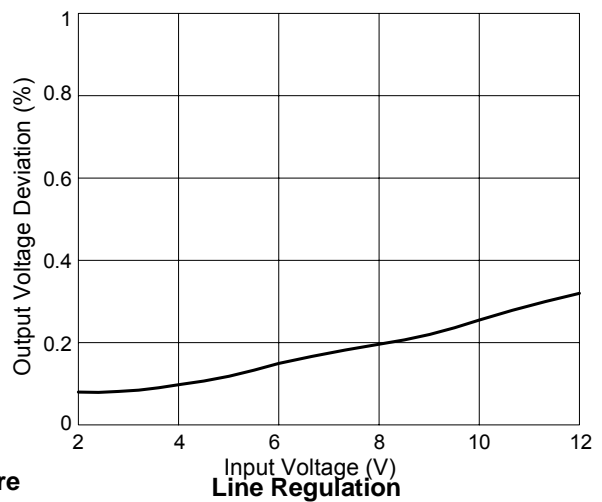
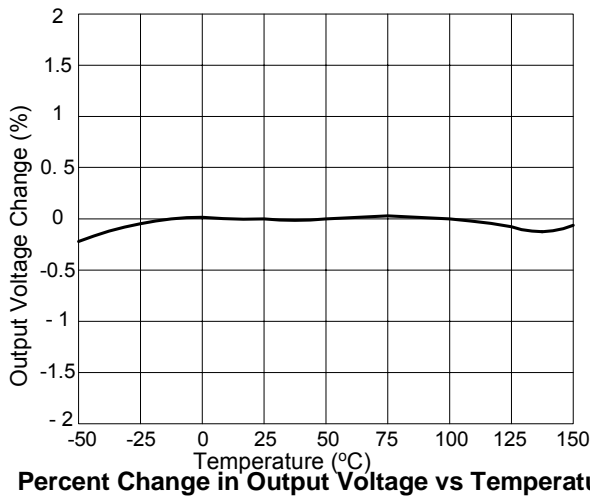
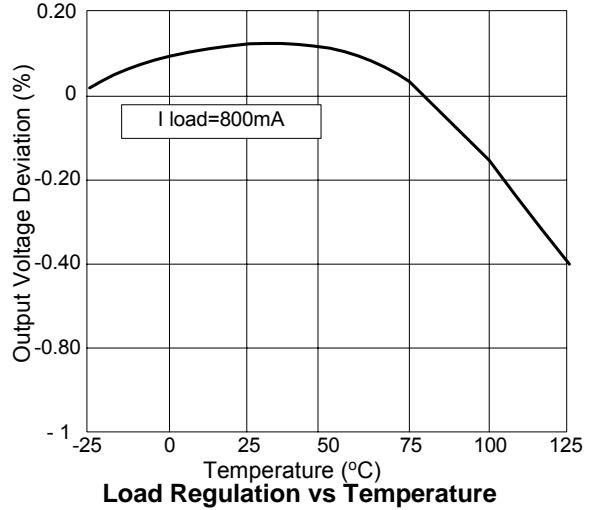
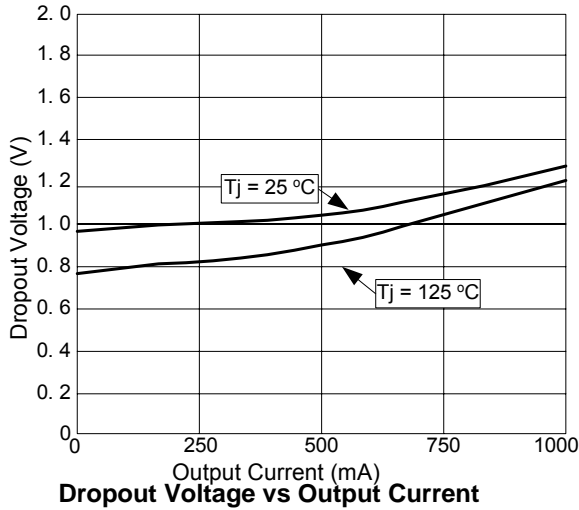



Package Outline : SOT-223

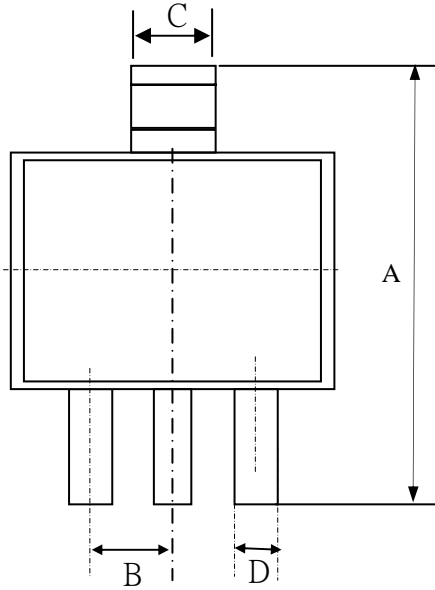

SYMBOLS	Millimeters		
	MIN	NOM	MAX
A	6.70	7.00	7.30
B	---	2.3	---
C	2.90	3.00	3.10
D	0.60	0.70	0.80
G	0.25	0.30	0.35
E	6.30	6.50	6.70
F	1.40	1.60	1.80
K	0.02	0.06	0.10

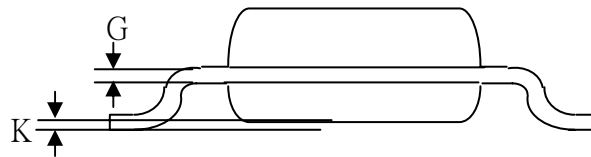
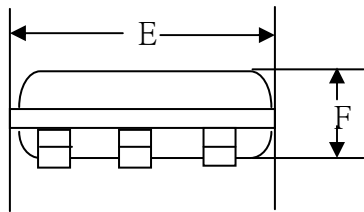

1. All Dimension Are In Millimeters.
2. Dimension Does Not Include Mold Protrusions.

Part Marking Information & Packing : SOT-223

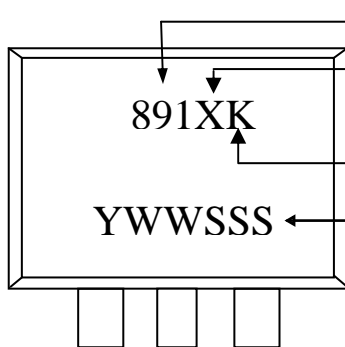

Part Number

Output Voltage

2 : 1.2V

3 : 1.32V

Package Code

K : SOT-223 ; KR : R-type SOT-223

Date Code (YWWSSS)

Y : Last Digit Of The Year

WW : Week

SSS : Sequence



Package Outline : TO-252

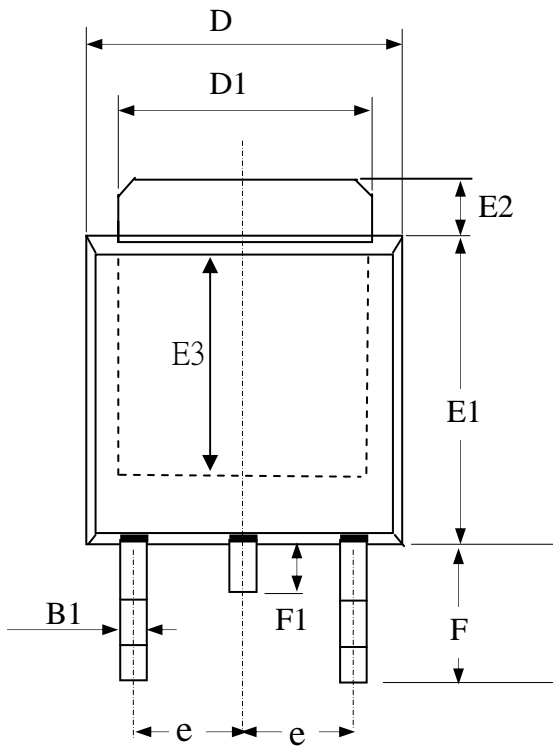

SYMBOLS	Millimeters		
	MIN	NOM	MAX
A2	1.80	2.30	2.80
A3	0.40	0.50	0.60
B1	0.40	0.70	1.00
D	6.00	6.50	7.00
D1	4.80	5.35	5.90
E3	3.50	4.00	4.50
F	2.20	2.63	3.05
F1	0.5	0.85	1.20
E1	5.10	5.70	6.30
E2	0.50	1.10	1.80
e	--	2.30	--
C	0.35	0.50	0.65

- 1.All Dimensions Are in Millimeters.
- 2.Dimension Does Not Include Mold Protrusions.

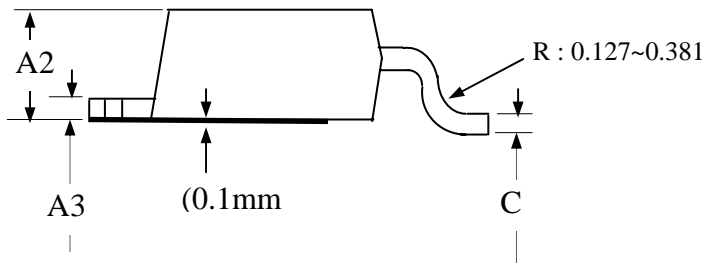

Part Marking Information & Packing : TO-252

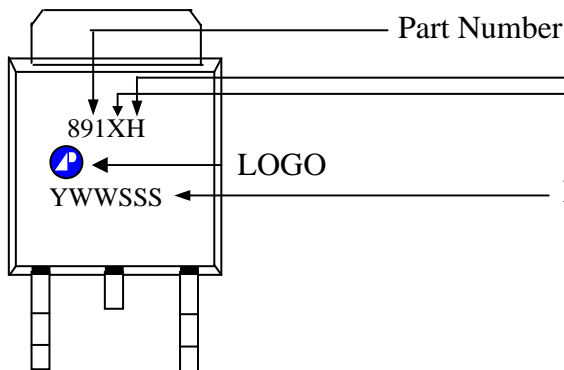

Package Code
Output Voltage

2 : 1.2V
3 : 1.32V

Date Code (YWWSSS)

Y : Last Digit Of The Year

WW : Week

SSS : Sequence



Package Outline & Packing : SOT-89

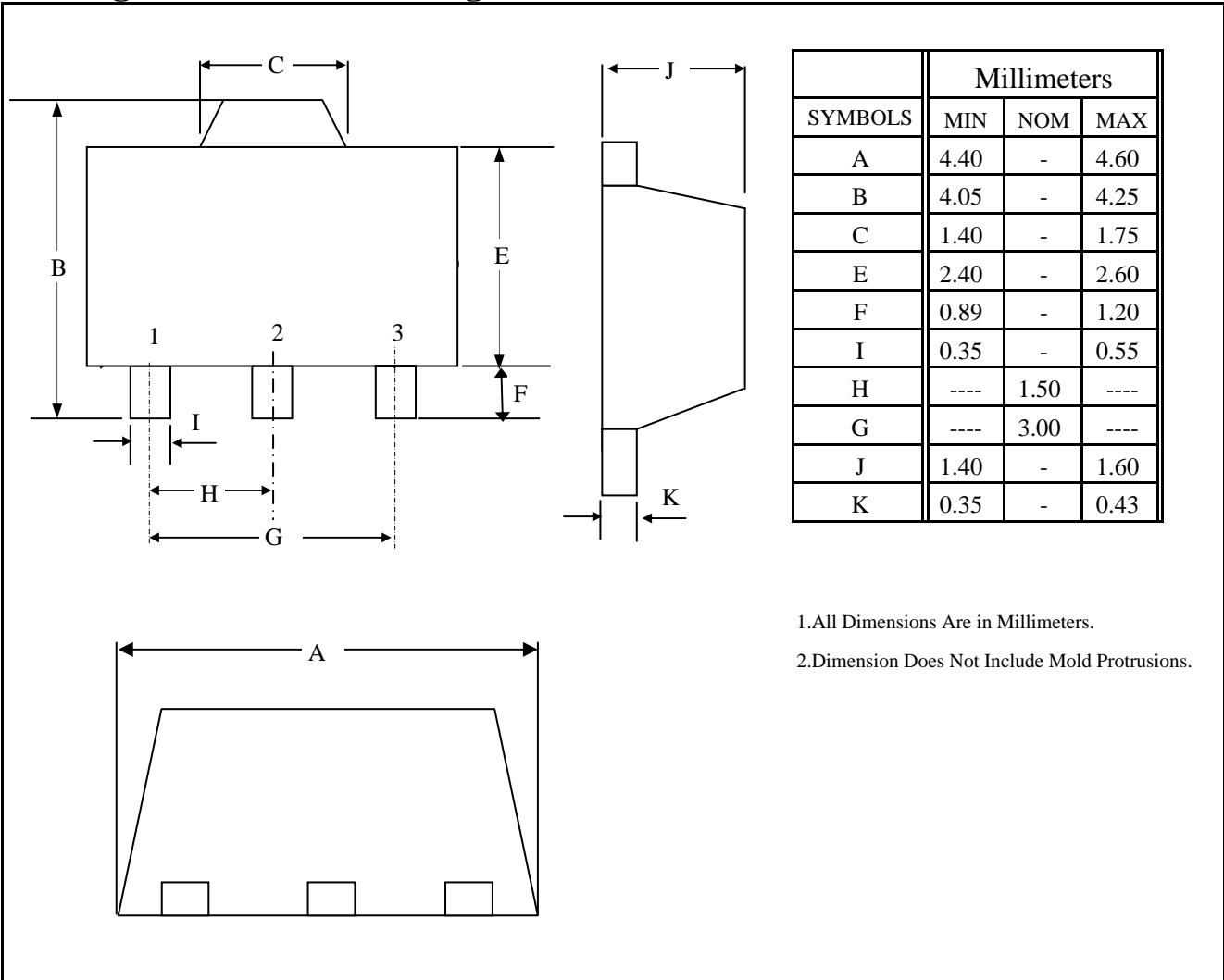

Part Marking Information : SOT-89

