

MGA-43128

High Linearity (700–800) MHz Wireless Data Power Amplifier



Data Sheet

Description

Avago Technologies' MGA-43128 is a high-linearity power amplifier for use in the (700-800) MHz band. High linear output power at 5V is achieved using Avago Technologies' proprietary 0.25 μm GaAs Enhancement-mode pHEMT process. It is housed in a miniature 5.0 x 5.0 x 0.85 mm³ 28-lead QFN package. It includes a shutdown and single-bit gain switch function. A detector is also included on-chip. The compact footprint coupled with high gain and high efficiency makes the MGA-43128 an ideal choice for UMTS 3GPP LTE driver and final stage amplifier applications.

Component Image

5.0 x 5.0 x 0.85 mm³ 28-lead QFN Package (Top View)

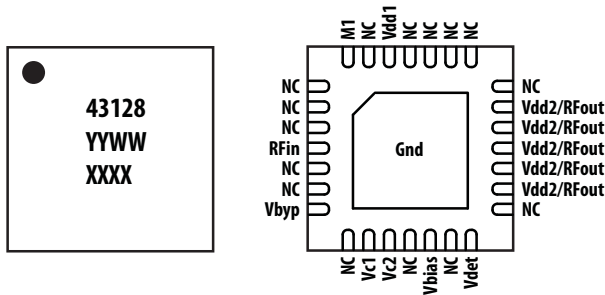

Notes:

Package marking provides orientation and identification

"43128" = Device Part Number

"YYWW" = Year and Work Week

"XXXX" = Assembly Lot Number

Functional Block Diagram

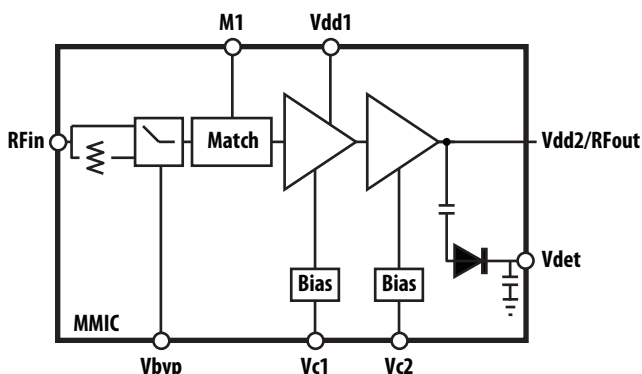

Features

- High gain: 33.4 dB
- High Power linear output: 29.1 dBm at 5 V supply (2.5% EVM, LTE 3GPP.TS 36.104, 10 MHz bandwidth OFDMA)
- Built-in detector and shutdown switches
- Switchable gain: 18 dB attenuation using one single CMOS compatible switch pin
- 3GPP spectral mask compliant at 29 dBm output power
- GaAs E-pHEMT Technology^[1]
- Low cost small package size: 5.0 x 5.0 x 0.85 mm³
- MSL-2a, lead-free and halogen free
- Useable at 3.3 V supply for lower supply voltage applications (27 dBm at 2.5% EVM, LTE 3GPP.TS 36.101, 10MHz bandwidth SC-FDMA)

Specifications

750 MHz; Vdd = Vbias = 5.0 V, Vc1 = 2.8 V, Vc2 = 2.4 V, Iqtotal = 370 mA (typ), LTE 3GPP.TS 36.104, 10 MHz bandwidth OFDMA

- 33.4 dB Gain
- 29.1 dBm Linear Pout (2.5% EVM)
- 36 dBm OP1dB
- 22% PAE @ Linear Pout
- 3.3 V Vdet @ Linear Pout
- 18 dB Switchable Gain Attenuation (Low Gain Mode)
- 40 μA Shutdown Current (Vc = Vbias = 0 V)

Applications

- High linearity amplifier for (700-800) MHz LTE AP, CPE, and Picocell
- Base Station Driver Amplifier

Note:

1. Enhancement mode technology employs positive Vgs, thereby eliminating the need of negative gate voltage associated with conventional depletion mode devices.



Attention: Observe precautions for handling electrostatic sensitive devices.

ESD Machine Model = 50 V

ESD Human Body Model = 500 V

Refer to Avago Application Note A004R:

Electrostatic Discharge, Damage and Control.

MGA-43128 Absolute Maximum Rating ^[1] T_A = 25° C

Symbol	Parameter	Units	Absolute Maximum
Vdd, Vbias	Supply Voltages, Bias Supply Voltage	V	6.0
Vc	Control Voltage	V	(Vdd)
P _{in,max}	CW RF Input Power	dBm	20
P _{diss}	Total Power Dissipation ^[3]	W	7.0
T _j	Junction Temperature	°C	150
T _{STG}	Storage Temperature	°C	-65 to 150

Thermal Resistance

Thermal Resistance ^[2]

$$\theta_{jc} = 13.5^{\circ}\text{C/W}$$

Notes:

1. Operation of this device in excess of any of these limits may cause permanent damage.
2. Thermal resistance measured using Infra-Red Measurement Technique.
3. Board temperature (T_c) is 25°C. For T_c >55.5°C, derate the device power at 74.1 mW per °C rise in board temperature adjacent to package bottom.

Electrical Specifications

T_A = 25° C, Vdd = Vbias = 5.0 V, Vc1 = 2.8 V, Vc2 = 2.4 V, Vbyp = 0 V, Iqtotal = 370 mA, RF performance at 750 MHz, LTE 3GPP. TS 36.104, 10 MHz bandwidth OFDMA operation unless otherwise stated.

Symbol	Parameter and Test Condition	Units	Min.	Typ.	Max.
Vdd	Supply Voltage			5.0	
Iqtotal	Quiescent Supply Current (normal high gain mode)	mA		370	
	Quiescent Supply Current (low gain mode, Vbyp = 5.0 V)	mA		370	
Gain	Gain	dB	31.5	33.4	
OP1dB	Output Power at 1 dB Gain Compression	dBm		36	
Pout_linear	Linear Output power with 3GPP LTE v8.6.0 (March 2009), 10 MHz bandwidth OFDMA @ 2.5% EVM	dBm	27.6	29.1	
Itotal_linear	Total current draw at Pout_linear level	mA		780	1000
S11	Input Return Loss, 50 Ω source	dB		-20	
S22	Output Return Loss, 50 Ω load	dB		-7	
S12	Reverse Isolation	dB		50	
2 Fc	Second harmonic attenuation @ Pin = -20 dBm	dBc		60	
Atten	Gain attenuation in low gain mode (Vbyp = 5.0 V)	dB	14.5	18	21.5
Vdet	Detector output DC voltage @ 29 dBm linear Pout	V		3.3	
DetR	Detector RF dynamic range	dB		17	
S	Stability under load VSWR of 6:1 (all phase angle), spurious output	dBc			-60

Product Consistency Distribution Charts [1]

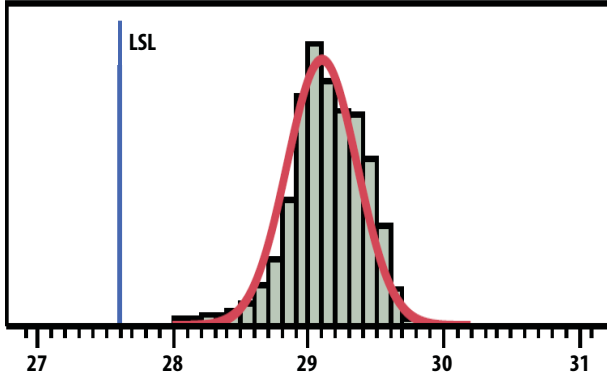

Figure 1. Pout_linear; LSL = 27.6 dBm, Nominal = 29.1 dBm

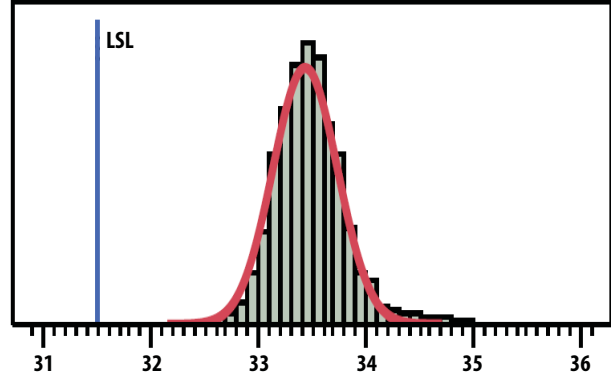

Figure 2. Gain; LSL = 31.5 dB, Nominal = 33.4 dB

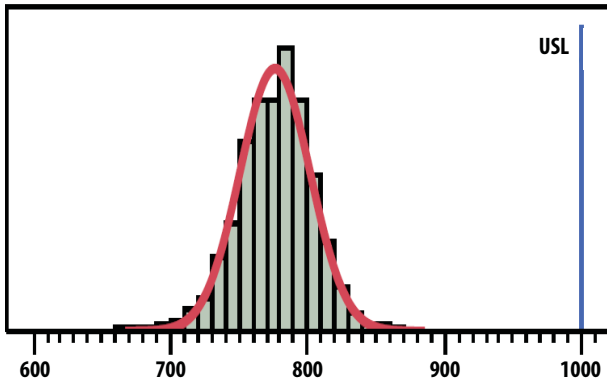

Figure 3. Itotal_linear; Nominal = 780 mA, USL = 1000 mA

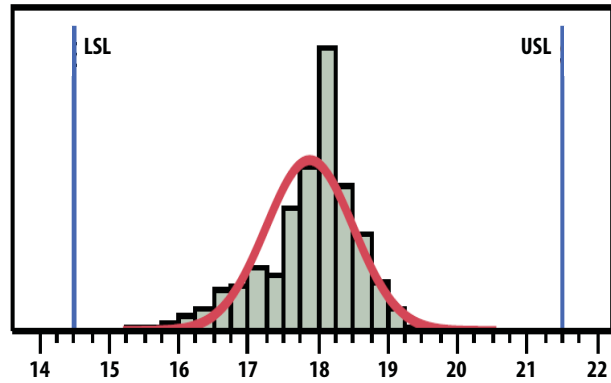

Figure 4. Atten; LSL = 14.5 dB, Nominal = 18 dB, USL = 21.5 dB; Vbyp = 5 V

Note:

1. Distribution data sample size is 3500 samples taken from 3 different wafer lots. $T_A = 25^\circ\text{C}$, $V_{dd} = V_{bias} = 5.0\text{ V}$, $V_{c1} = 2.8\text{ V}$, $V_{c2} = 2.4\text{ V}$, $V_{byp} = 0\text{ V}$, RF performance at 750 MHz unless otherwise stated. Future wafers allocated to this product may have nominal values anywhere between the upper and lower limits.

MGA-43128 Typical Performance

$T_A = 25^\circ\text{C}$, $V_{dd} = V_{bias} = 5.0\text{V}$, $V_{c1} = 2.8\text{V}$, $V_{c2} = 2.4\text{V}$, $V_{byp} = 0\text{V}$, $I_{qtotal} = 370\text{mA}$, RF performance at 750 MHz, LTE 3GPP. TS 36.104, 10 MHz bandwidth OFDMA operation unless otherwise stated.

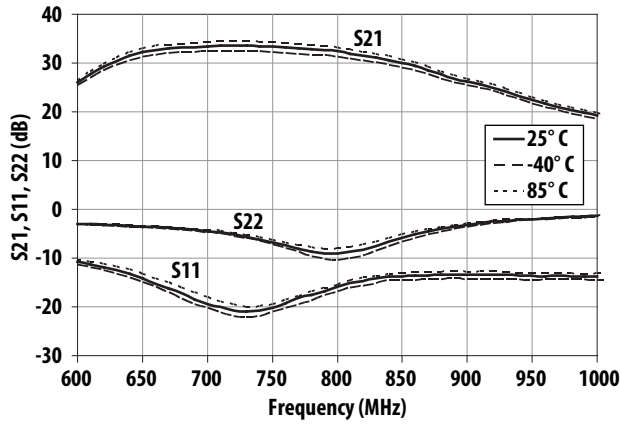

Figure 5. Small-signal performance in high gain mode, $V_{byp} = 0\text{V}$

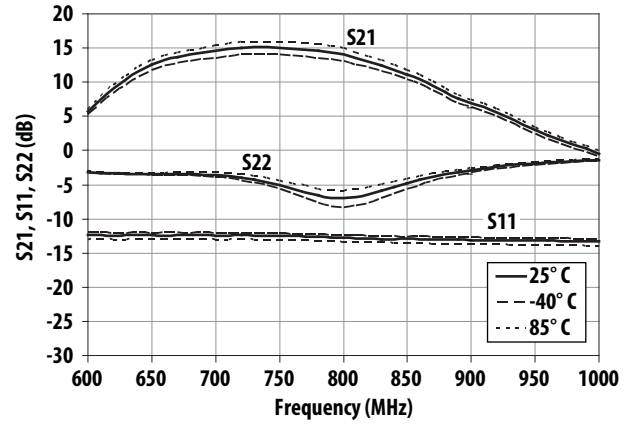

Figure 6. Small-signal performance in low gain mode, $V_{byp} = 5.0\text{V}$

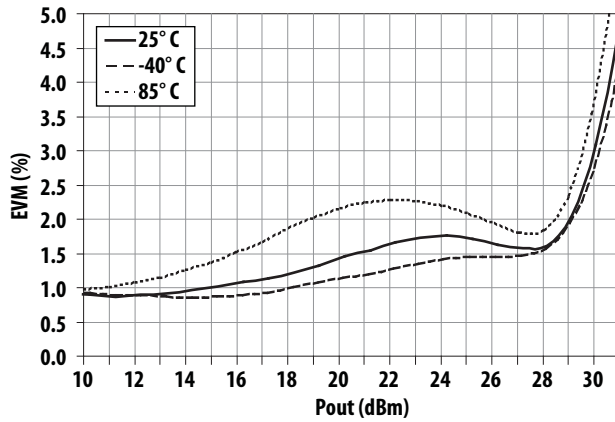

Figure 7. Over-temperature EVM vs Output Power at 728 MHz

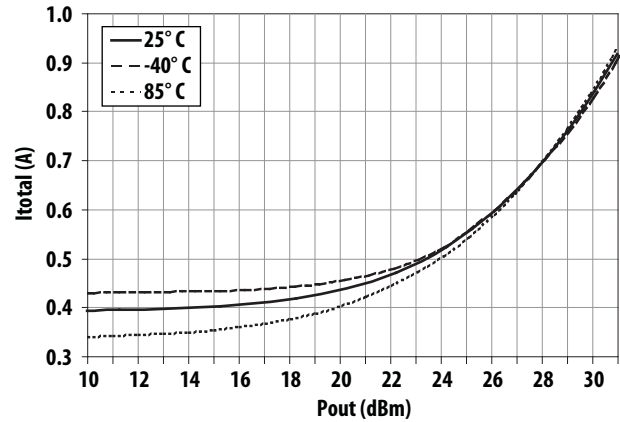

Figure 8. Over-temperature I_{dd_total} vs Output Power at 728 MHz

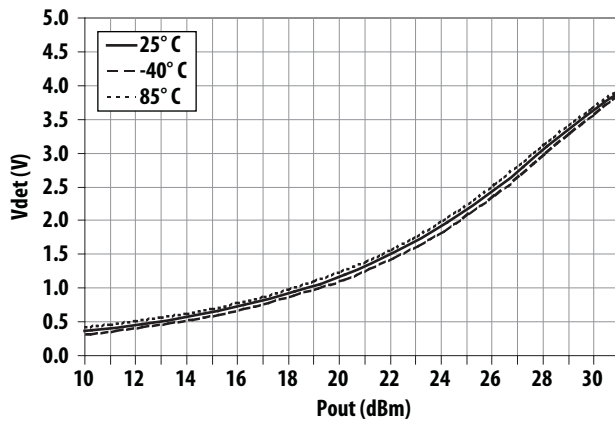

Figure 9. Over-temperature V_{det} vs Output Power at 728 MHz

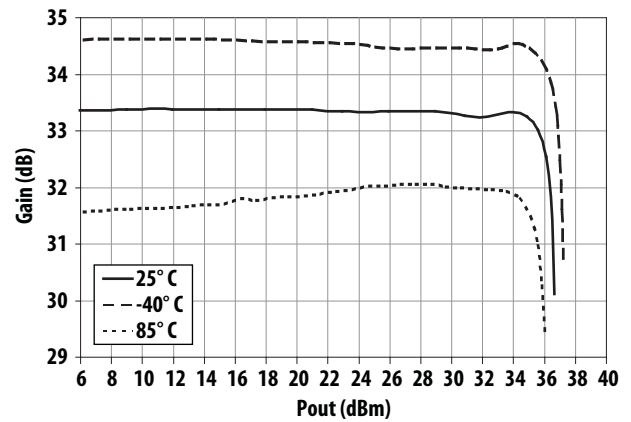

Figure 10. Over-temperature CW Gain vs Output Power at 728 MHz

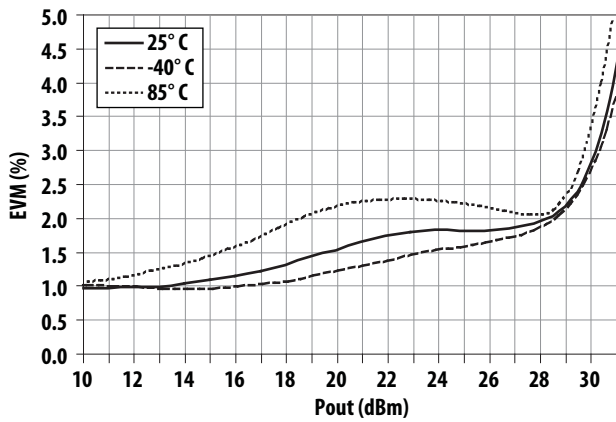

Figure 11. Over-temperature EVM vs Output Power at 750 MHz

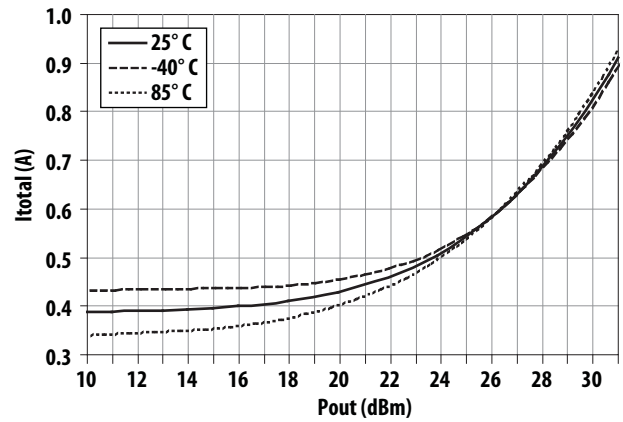

Figure 12. Over-temperature Idd_total vs Output Power at 750 MHz

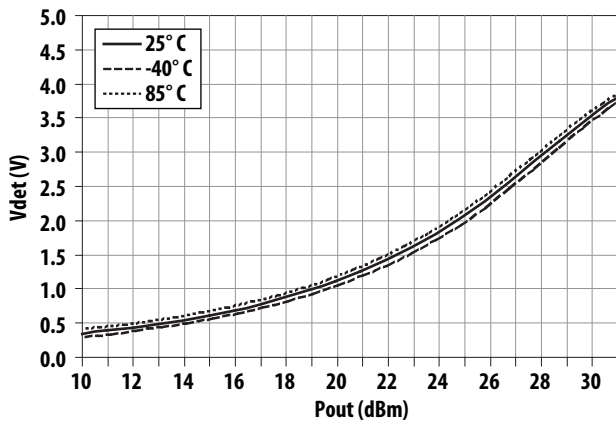

Figure 13. Over-temperature Vdet vs Output Power at 750 MHz

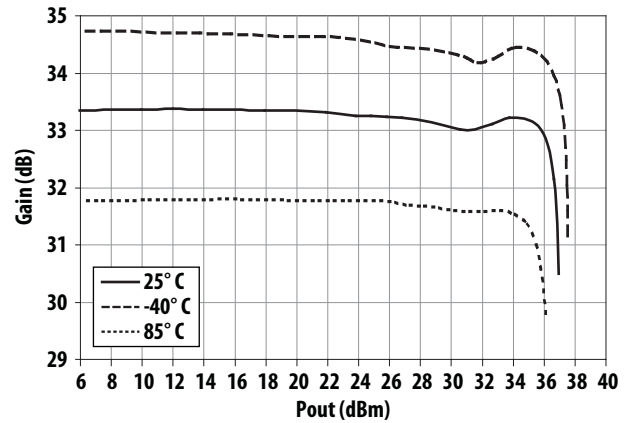

Figure 14. Over-temperature CW Gain vs Output Power at 750 MHz

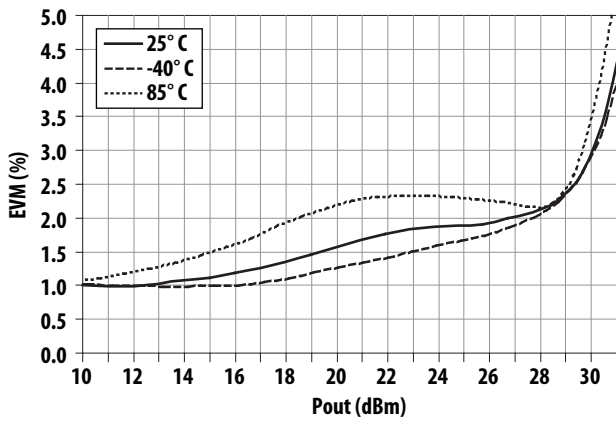

Figure 15. Over-temperature EVM vs Output Power at 756 MHz

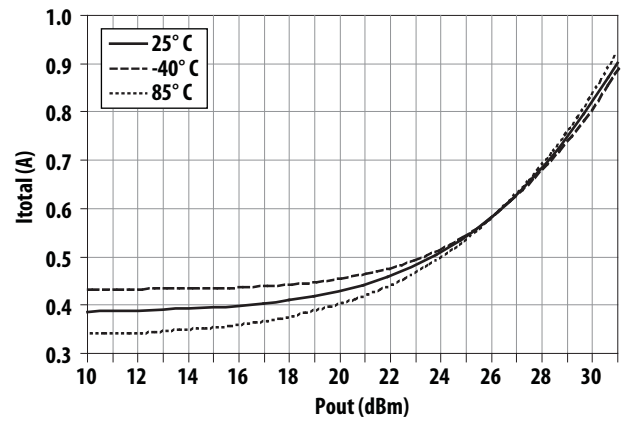

Figure 16. Over-temperature Idd_total vs Output Power at 756 MHz

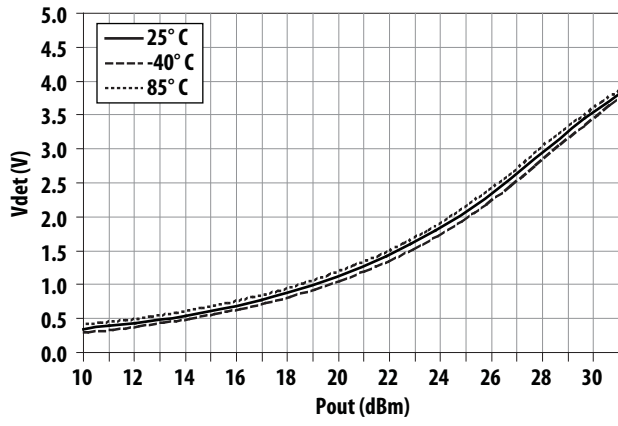

Figure 17. Over-temperature Vdet vs Output Power at 756 MHz

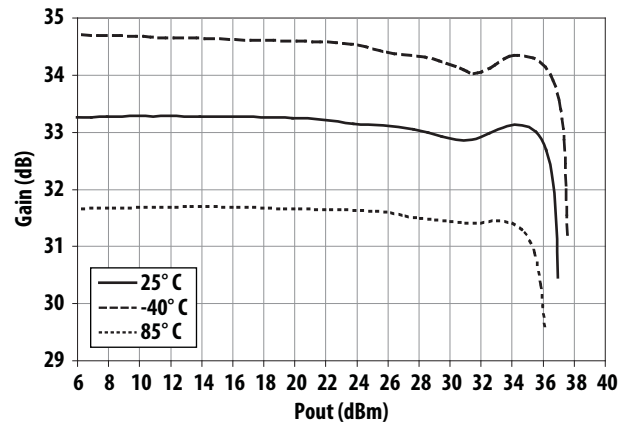

Figure 18. Over-temperature CW Gain vs Output Power at 756 MHz

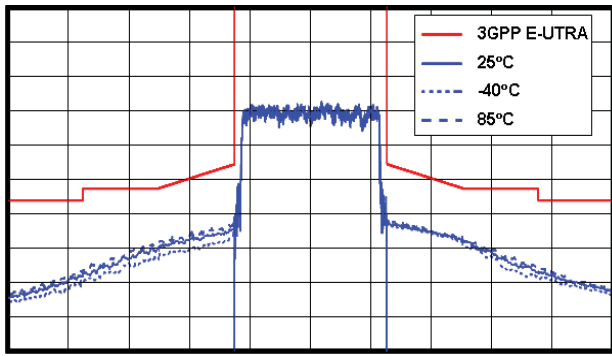

Figure 19. 3GPP E-UTRA bands < 1 GHz Category B Spectrum Emission Mask at Pout 29 dBm at 728 MHz

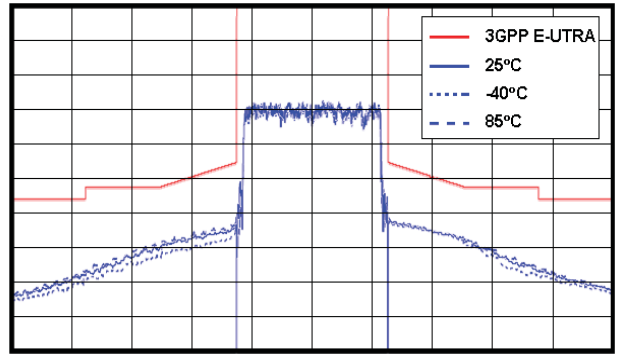

Figure 20. 3GPP E-UTRA bands 12,13 Additional Spectrum Emission Mask at Pout 29 dBm at 728 MHz

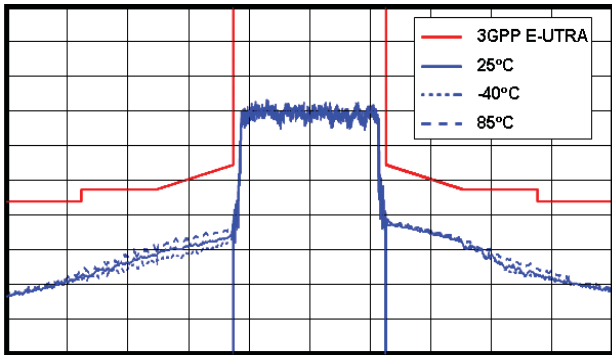

Figure 21. 3GPP E-UTRA bands < 1 GHz Category B Spectrum Emission Mask at Pout 29 dBm at 750 MHz

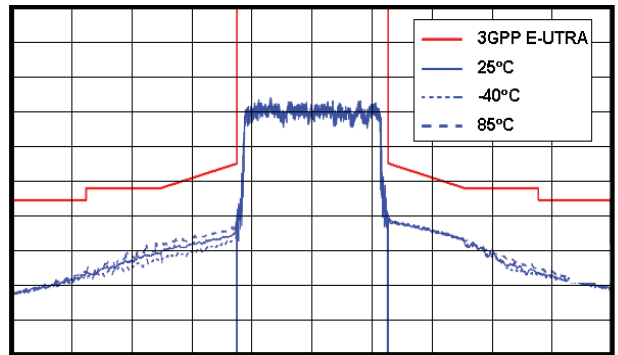

Figure 22. 3GPP E-UTRA bands 12,13 Additional Spectrum Emission Mask at Pout 29 dBm at 750 MHz

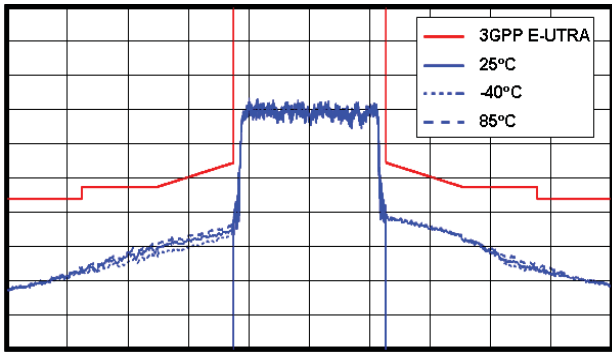

Figure 23. 3GPP E-UTRA bands < 1 GHz Category B Spectrum Emission Mask at Pout 29 dBm at 756 MHz

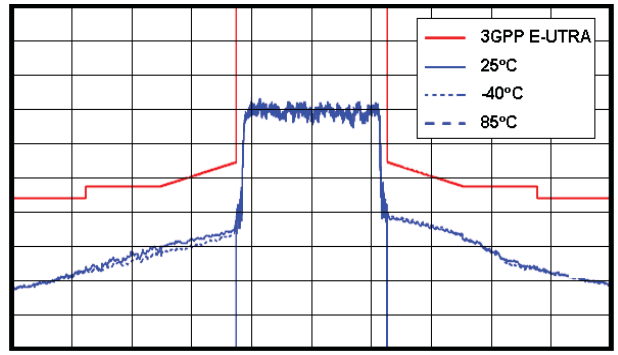

Figure 24. 3GPP E-UTRA bands 12,13 Additional Spectrum Emission Mask at Pout 29 dBm at 756 MHz

MGA-43128 Typical Performance

$T_A = 25^\circ\text{C}$, $V_{dd} = V_{bias} = 3.3\text{V}$, $V_{c1} = 2.8\text{V}$, $V_{c2} = 2.3\text{V}$, $V_{byp} = 0\text{V}$, $I_{qtotal} = 260\text{mA}$, RF performance at 750 MHz, LTE 3GPP. TS 36.101, 10 MHz bandwidth SC-FDMA operation unless otherwise stated.

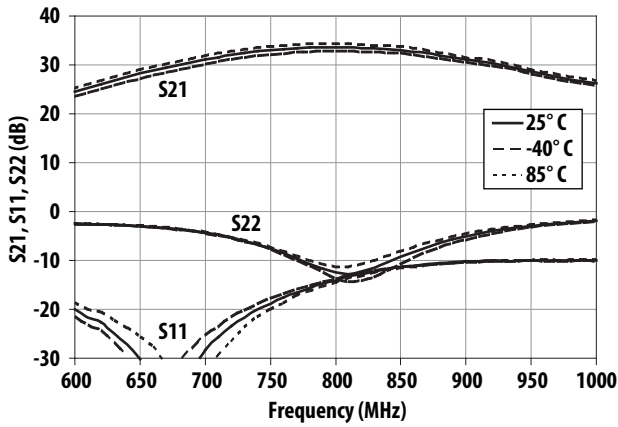

Figure 25. Small-signal performance in high gain mode, $V_{byp} = 0\text{V}$

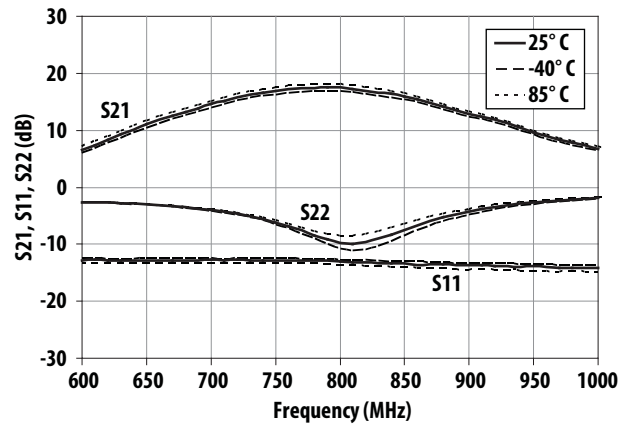

Figure 26. Small-signal performance in low gain mode, $V_{byp} = 3.3\text{V}$

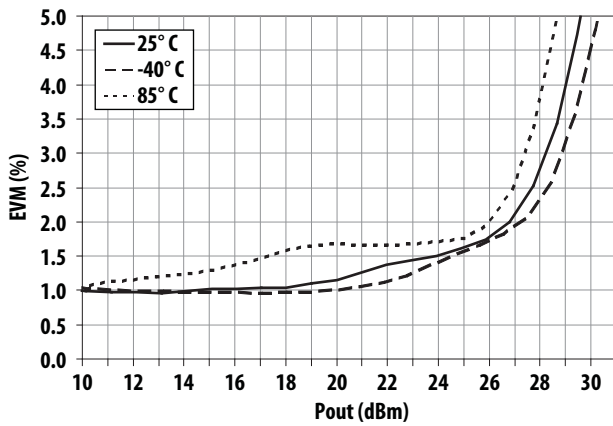

Figure 27. Over-temperature EVM vs Output Power at 698 MHz

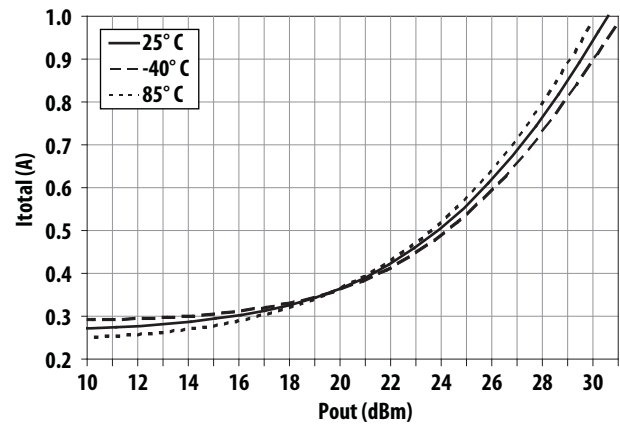

Figure 28. Over-temperature I_{dd_total} vs Output Power at 698 MHz

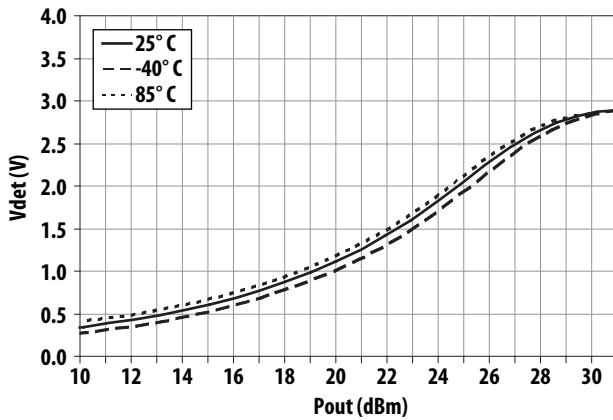

Figure 29. Over-temperature V_{det} vs Output Power at 698 MHz

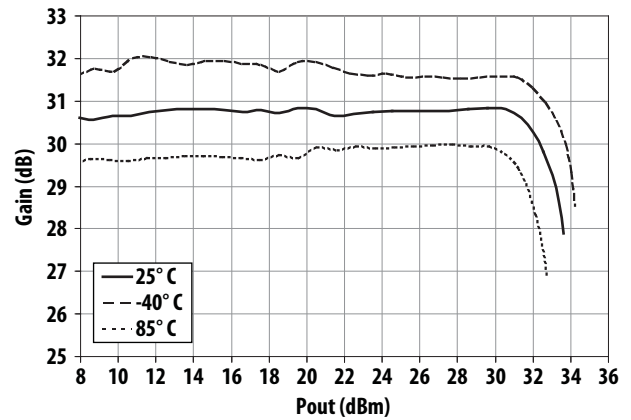

Figure 30. Over-temperature CW Gain vs Output Power at 698 MHz

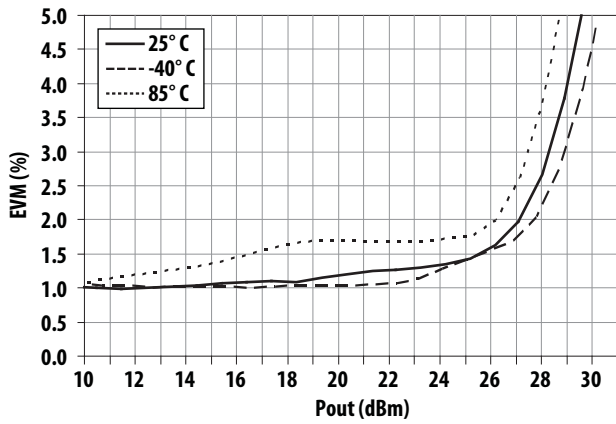

Figure 31. Over-temperature EVM vs Output Power at 706 MHz

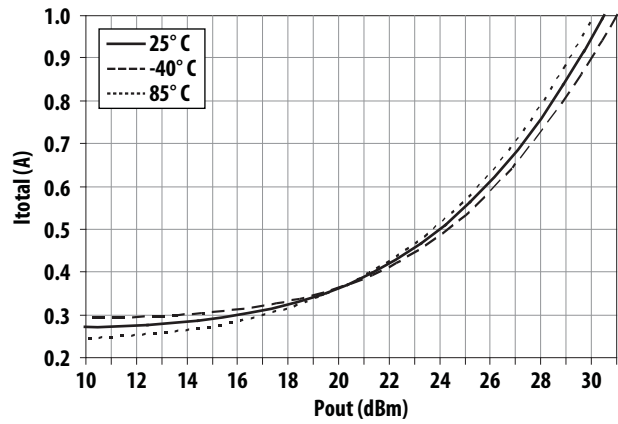

Figure 32. Over-temperature Idd_total vs Output Power at 706 MHz

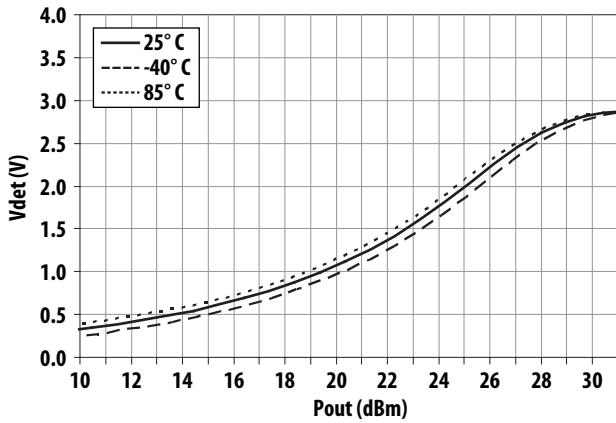

Figure 33. Over-temperature Vdet vs Output Power at 706 MHz

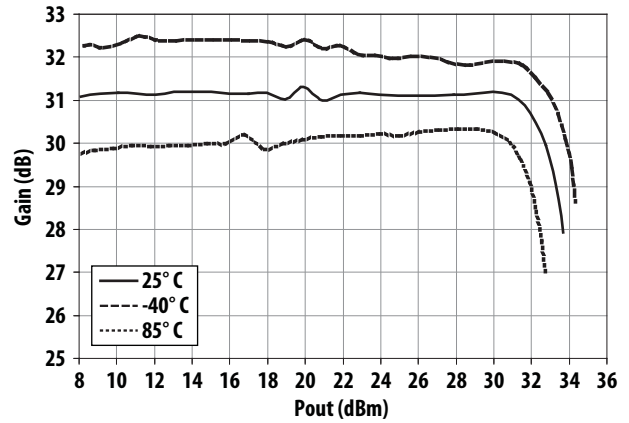

Figure 34. Over-temperature CW Gain vs Output Power at 706 MHz

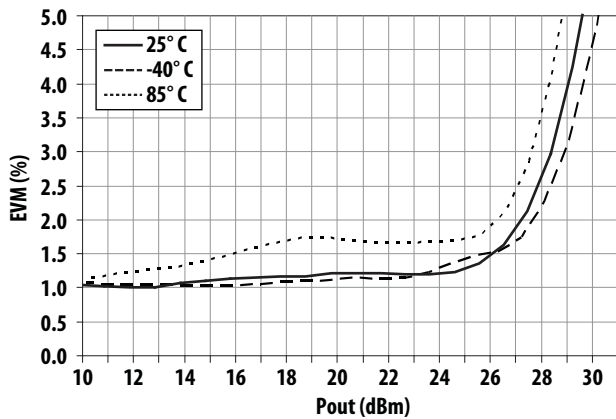

Figure 35. Over-temperature EVM vs Output Power at 716 MHz

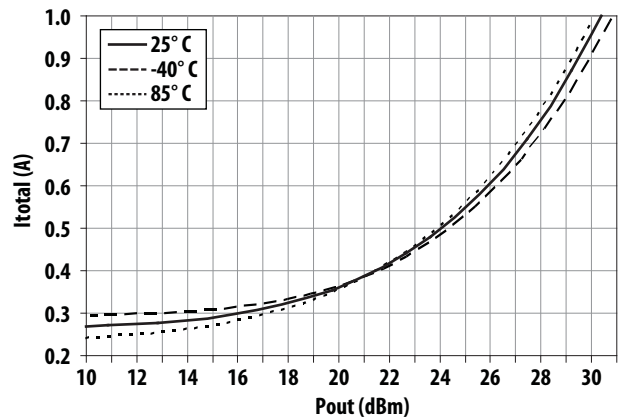

Figure 36. Over-temperature Idd_total vs Output Power at 716 MHz

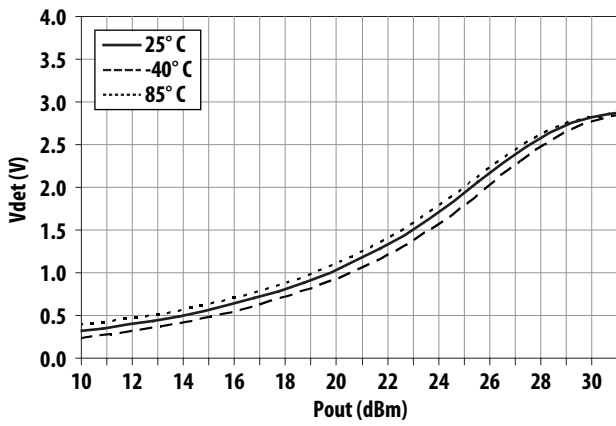

Figure 37. Over-temperature Vdet vs Output Power at 716 MHz

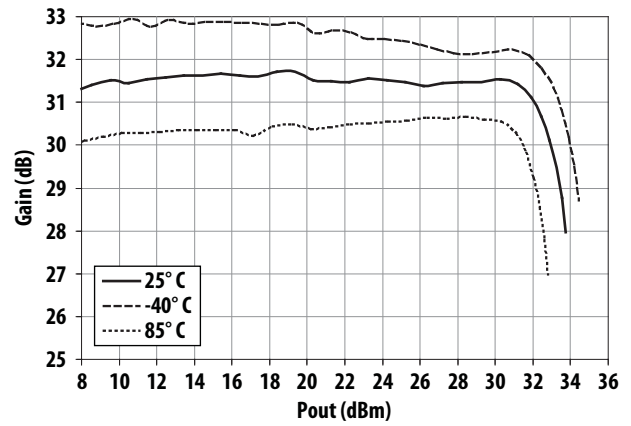

Figure 38. Over-temperature CW Gain vs Output Power at 716 MHz

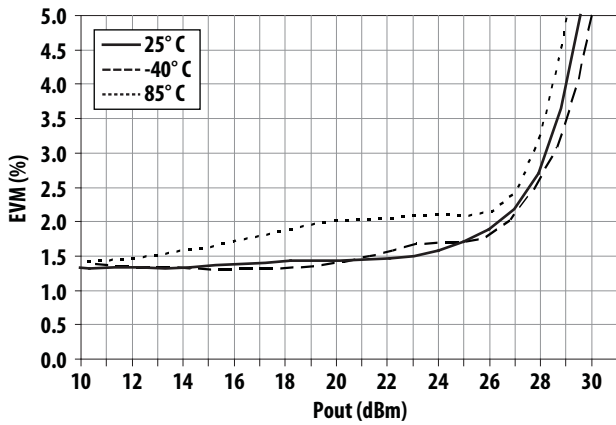

Figure 39. Over-temperature EVM vs Output Power at 777 MHz

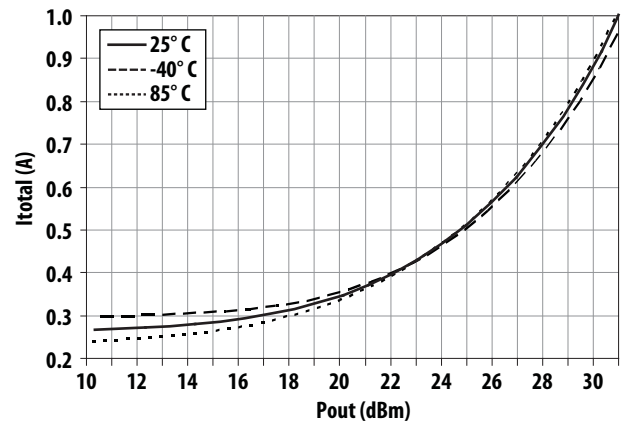

Figure 40. Over-temperature Idd_total vs Output Power at 777 MHz

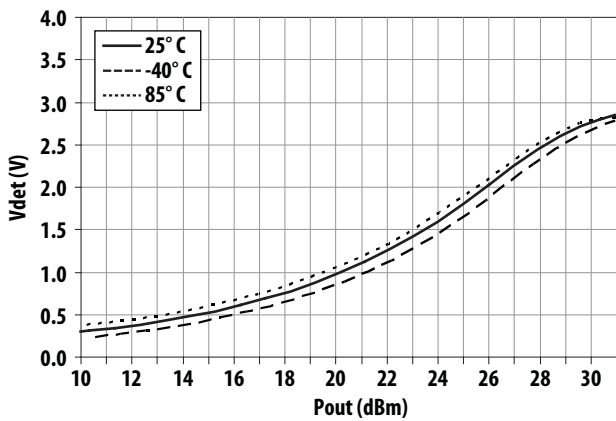

Figure 41. Over-temperature Vdet vs Output Power at 777 MHz

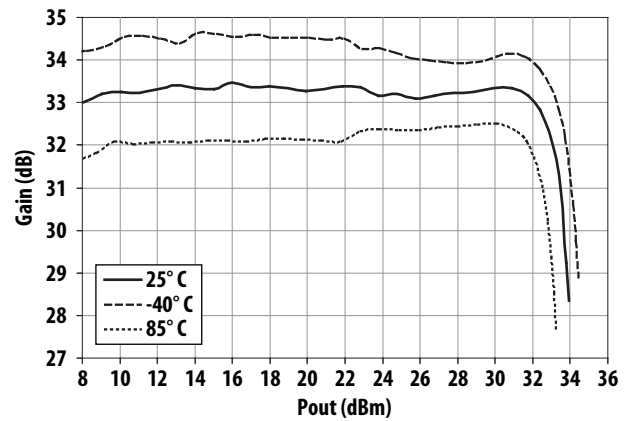

Figure 42. Over-temperature CW Gain vs Output Power at 777 MHz

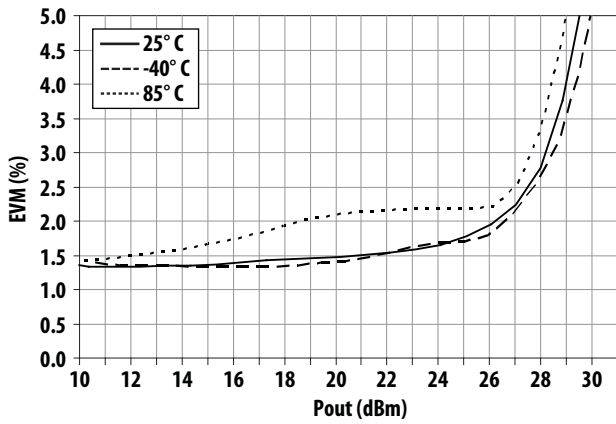

Figure 43. Over-temperature EVM vs Output Power at 782 MHz

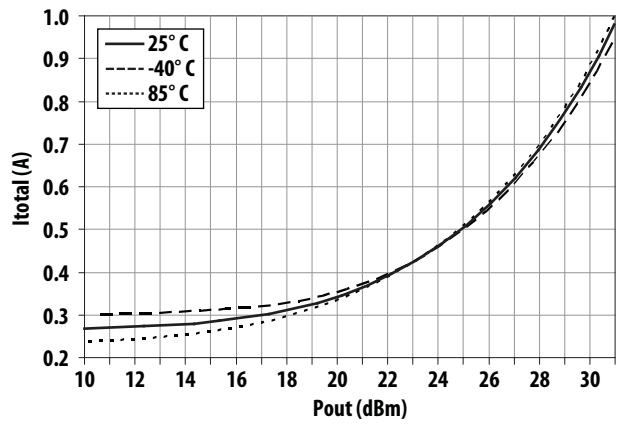

Figure 44. Over-temperature Idd_total vs Output Power at 782 MHz

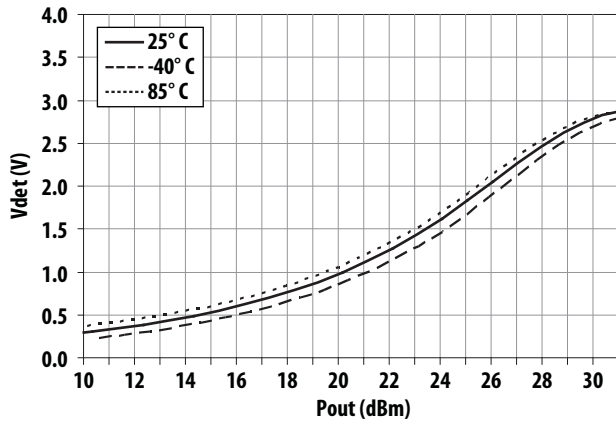

Figure 45. Over-temperature Vdet vs Output Power at 782 MHz

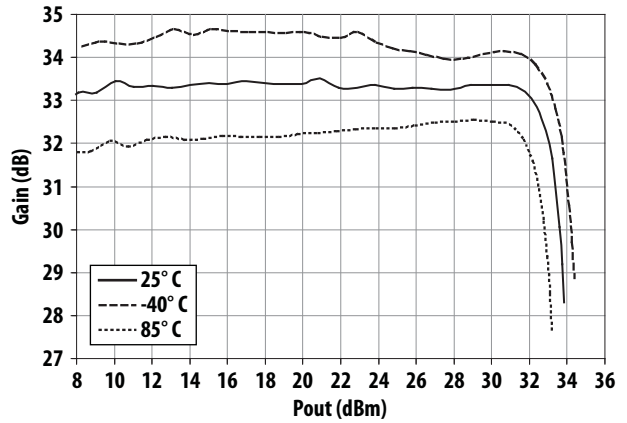

Figure 46. Over-temperature CW Gain vs Output Power at 782 MHz

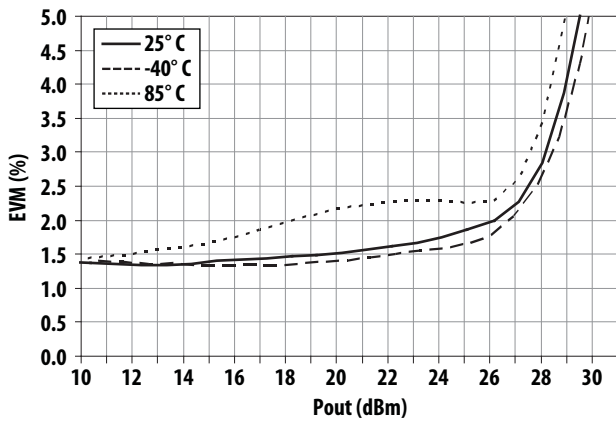

Figure 47. Over-temperature EVM vs Output Power at 787 MHz

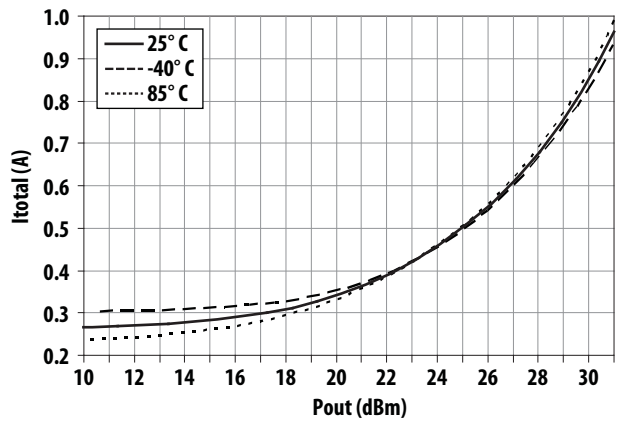

Figure 48. Over-temperature Idd_total vs Output Power at 787 MHz

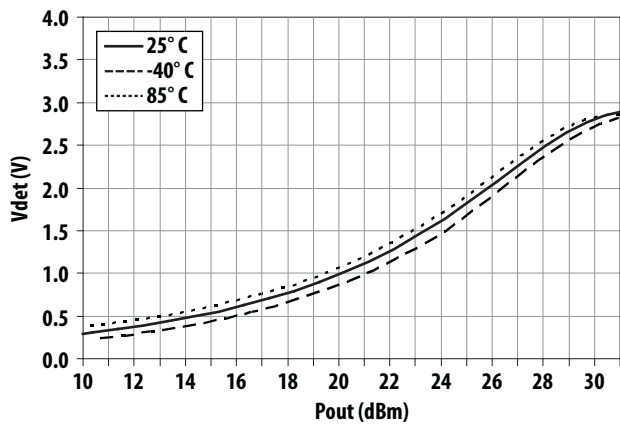

Figure 49. Over-temperature Vdet vs Output Power at 787 MHz

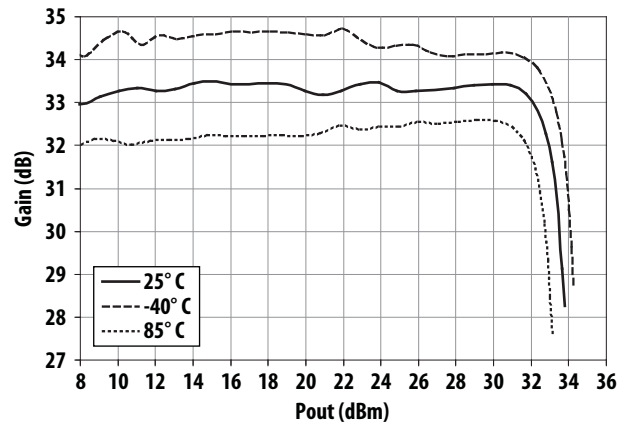

Figure 50. Over-temperature CW Gain vs Output Power at 787 MHz

S-Parameter^[1] (Vdd = Vbias = 5.0 V, Vc1 = 2.8 V, Vc2 = 2.4 V, Vbyp = 0 V, T = 25° C, unmatched)

Freq (GHz)	S11 (dB)	S11 (Ang)	S21 (dB)	S21 (Ang)	S12 (dB)	S12 (Ang)	S22 (dB)	S22 (Ang)
0.1	-8.14	-35.30	-47.42	-5.87	-48.92	-159.35	-1.46	178.41
0.2	-7.31	-68.56	-21.87	-8.50	-57.70	159.14	-1.06	-178.87
0.3	-6.48	-101.78	-3.17	-38.71	-62.88	92.49	-0.95	-178.86
0.4	-6.23	-135.74	13.29	-90.66	-61.50	-97.85	-0.92	-178.64
0.5	-7.87	-164.40	22.16	145.80	-57.88	-134.74	-0.84	-177.81
0.6	-9.90	169.63	21.00	146.66	-64.82	35.29	-0.64	-177.41
0.7	-16.37	176.11	27.51	47.33	-73.33	173.44	-0.40	-177.66
0.8	-15.41	-167.69	23.81	-12.00	-57.62	76.49	-0.23	-179.17
0.9	-14.69	-165.45	20.13	-47.59	-55.52	115.43	-0.17	179.41
1.0	-14.47	-163.62	16.68	-73.16	-59.22	151.66	-0.20	178.20
1.1	-14.13	-163.59	12.81	-93.36	-58.34	148.52	-0.25	177.17
1.2	-13.29	-165.43	6.30	-108.21	-56.59	103.00	-0.30	176.30
1.3	-12.72	-167.44	0.22	8.83	-60.14	97.90	-0.38	175.36
1.4	-11.92	-163.10	15.79	-10.94	-54.96	75.33	-0.54	175.12
1.5	-9.13	-167.99	19.49	-73.15	-58.94	78.81	-0.51	175.98
1.6	-8.25	179.58	17.26	-110.82	-56.48	95.50	-0.39	175.21
1.7	-7.85	171.31	15.02	-130.45	-54.63	85.66	-0.37	174.38
1.8	-7.44	164.79	13.28	-143.72	-53.43	82.54	-0.39	173.65
1.9	-7.08	158.53	11.87	-154.39	-52.98	83.05	-0.39	172.90
2.0	-6.72	152.63	10.67	-163.70	-52.29	68.13	-0.40	172.11
2.1	-6.41	147.12	9.62	-171.91	-53.43	71.77	-0.43	171.39
2.2	-6.10	141.88	8.73	-179.59	-53.67	68.02	-0.44	170.56
2.3	-5.81	136.60	7.91	-172.46	-54.00	47.31	-0.48	169.79
2.4	-5.53	131.41	7.07	-165.18	-53.82	65.89	-0.50	168.98
2.5	-5.29	126.26	6.31	-158.22	-50.94	62.14	-0.54	168.15
2.6	-5.07	121.15	5.56	-151.91	-52.94	47.01	-0.56	167.33
2.7	-4.86	116.41	4.91	-145.58	-48.67	55.89	-0.59	166.44
2.8	-4.66	111.48	4.31	-139.45	-54.58	30.83	-0.61	165.42
2.9	-4.46	106.95	3.74	-133.41	-51.97	60.93	-0.64	164.35
3.0	-4.29	102.32	3.21	-127.41	-51.76	67.83	-0.68	163.37
4.0	-2.85	63.15	0.67	58.70	-47.20	29.01	-2.05	148.16
5.0	-2.66	37.90	-12.25	61.62	-57.05	5.98	-0.22	151.26
6.0	-2.18	25.64	-12.37	10.32	-53.33	-7.48	-0.31	142.65
7.0	-2.43	13.04	-14.10	-23.35	-51.61	0.87	-0.42	136.62
8.0	-3.11	-5.76	-13.87	-62.74	-54.07	-28.02	-0.72	127.31
9.0	-3.46	-30.56	-12.75	-115.55	-48.58	-66.78	-1.71	108.78
10.0	-3.07	-46.00	-14.51	113.24	-47.29	-115.44	-6.23	-163.51
11.0	-2.37	-48.16	-34.00	118.81	-59.20	-178.76	-0.39	129.62
12.0	-2.08	-42.93	-30.43	146.98	-56.82	-92.88	-0.37	109.25
13.0	-2.16	-44.72	-32.94	119.69	-55.06	-90.14	-0.37	95.58
14.0	-2.37	-64.86	-33.75	82.63	-51.20	-122.91	-0.46	88.61
15.0	-1.95	-97.74	-35.00	51.90	-48.40	-142.84	-0.76	79.95
16.0	-1.27	-118.51	-38.27	25.62	-47.03	153.45	-0.99	66.53
17.0	-0.89	-120.81	-38.52	-9.94	-47.28	98.28	-1.24	46.63
18.0	-1.12	-120.66	-37.86	1.87	-39.61	43.37	-1.35	22.60
19.0	-5.11	-116.49	-25.04	-75.18	-25.00	-83.39	-2.96	-2.34
20.0	-2.01	-160.45	-33.31	-169.08	-39.70	166.98	-2.89	3.06

Note:

1. S-parameter is measured with deembedded reference plane at DUT RFin and RFout pins.

S-Parameter^[1] (Vdd = Vbias = 5.0 V, Vc1 = 2.8 V, Vc2 = 2.4 V, Vbyp = 5 V, T = 25° C, unmatched)

Freq (GHz)	S11 (dB)	S11 (Ang)	S21 (dB)	S21 (Ang)	S12 (dB)	S12 (Ang)	S22 (dB)	S22 (Ang)
0.1	-11.94	-8.51	-49.44	-39.74	-46.82	-30.34	-1.47	178.53
0.2	-12.35	-10.89	-37.99	-48.26	-60.54	-46.49	-1.06	-179.02
0.3	-12.74	-12.94	-21.71	-76.41	-54.89	-93.53	-0.95	-178.99
0.4	-13.11	-15.88	-7.11	-117.76	-61.47	22.46	-0.91	-178.85
0.5	-13.04	-18.39	1.50	130.99	-58.14	118.66	-0.86	-178.16
0.6	-13.01	-21.76	0.66	140.87	-68.59	32.18	-0.68	-177.78
0.7	-12.96	-25.86	8.77	41.10	-59.23	-85.20	-0.34	-177.11
0.8	-13.03	-30.11	5.00	-22.83	-57.64	-11.42	-0.12	-179.71
0.9	-13.22	-33.69	1.12	-60.52	-58.18	-26.30	-0.14	178.56
1.0	-12.98	-35.55	-2.63	-87.89	-61.48	155.13	-0.21	177.44
1.1	-12.81	-36.88	-6.88	-109.63	-56.94	81.57	-0.27	176.56
1.2	-13.00	-41.20	-13.82	-125.89	-60.36	21.70	-0.32	175.84
1.3	-13.34	-44.60	-20.25	-7.88	-61.07	-47.01	-0.37	174.94
1.4	-13.47	-48.70	-5.07	-31.29	-63.26	66.70	-0.53	174.32
1.5	-13.78	-53.01	-2.56	-95.16	-58.12	83.32	-0.57	175.09
1.6	-14.09	-56.27	-5.61	-129.67	-61.56	85.29	-0.46	174.67
1.7	-14.43	-60.47	-8.43	-146.48	-58.06	69.87	-0.43	173.91
1.8	-14.80	-64.85	-10.75	-157.23	-56.29	72.32	-0.43	173.20
1.9	-15.20	-69.11	-12.70	-165.08	-54.07	83.09	-0.42	172.45
2.0	-15.58	-72.87	-14.45	-171.21	-54.82	59.94	-0.44	171.64
2.1	-16.05	-77.36	-16.04	-176.03	-58.27	-12.33	-0.46	170.85
2.2	-16.39	-82.04	-17.44	-179.38	-58.14	85.19	-0.45	169.94
2.3	-16.87	-87.57	-18.59	177.72	-55.54	82.02	-0.49	169.12
2.4	-17.60	-92.35	-19.76	174.76	-52.01	60.55	-0.52	168.19
2.5	-18.03	-97.93	-20.89	172.55	-55.89	78.49	-0.54	167.42
2.6	-18.66	-104.26	-21.90	172.64	-57.11	52.76	-0.55	166.47
2.7	-19.33	-111.07	-22.61	171.67	-60.99	88.76	-0.57	165.51
2.8	-20.10	-118.74	-23.19	171.49	-56.86	97.22	-0.59	164.50
2.9	-20.79	-127.09	-23.74	171.01	-51.97	50.77	-0.64	163.39
3.0	-21.60	-136.55	-23.91	171.42	-52.61	61.08	-0.66	162.30
4.0	-16.34	110.44	-21.81	135.34	-49.16	40.50	-2.01	146.68
5.0	-8.79	76.28	-30.55	139.37	-54.37	37.68	-0.21	149.36
6.0	-5.35	58.70	-28.50	88.40	-54.30	9.34	-0.30	140.53
7.0	-3.73	44.52	-28.57	55.97	-50.77	-3.75	-0.43	133.88
8.0	-3.12	25.09	-27.26	20.45	-48.29	-20.92	-0.71	124.43
9.0	-2.49	-5.31	-24.75	-29.37	-48.65	-51.40	-1.73	105.44
10.0	-1.57	-31.23	-25.49	-154.19	-49.37	-144.33	-6.23	-167.65
11.0	-0.95	-41.37	-44.37	-153.26	-65.45	-164.94	-0.38	126.17
12.0	-0.71	-41.57	-37.93	-106.47	-55.36	-68.46	-0.38	105.04
13.0	-0.86	-45.72	-38.33	-122.24	-55.73	-69.82	-0.38	91.24
14.0	-1.22	-67.34	-36.30	-157.35	-49.66	-114.15	-0.49	82.28
15.0	-1.17	-100.69	-34.91	166.11	-46.90	-148.27	-0.73	73.98
16.0	-0.75	-121.46	-35.16	120.62	-46.79	169.61	-1.02	61.39
17.0	-0.59	-124.51	-35.92	74.33	-47.10	96.83	-1.23	40.92
18.0	-1.02	-124.91	-32.86	26.56	-38.05	44.39	-1.38	16.87
19.0	-4.80	-118.77	-26.49	-94.70	-24.57	-91.02	-3.02	-10.14
20.0	-1.78	-163.50	-39.35	-127.38	-42.71	161.68	-2.86	-4.30

Note:

1. S-parameter is measured with deembedded reference plane at DUT RFin and RFout pins.

S-Parameter^[1] (Vdd = Vbias = 3.3 V, Vc1 = 2.8 V, Vc2 = 2.3 V, Vbyp = 0 V, T = 25° C, unmatched)

Freq (GHz)	S11 (dB)	S11 (Ang)	S21 (dB)	S21 (Ang)	S12 (dB)	S12 (Ang)	S22 (dB)	S22 (Ang)
0.1	-8.10	-35.22	-49.86	10.41	-51.11	61.42	-1.62	178.92
0.2	-7.31	-71.21	-17.88	-23.89	-56.56	149.66	-1.11	-177.87
0.3	-6.78	-109.64	-10.40	-110.63	-60.56	-104.69	-0.97	-177.55
0.4	-7.63	-151.19	1.22	-105.42	-64.66	67.21	-0.86	-176.91
0.5	-11.35	172.34	11.72	-151.11	-67.75	-25.09	-0.66	-176.08
0.6	-19.50	143.94	19.33	155.29	-62.07	130.09	-0.44	-176.21
0.7	-25.10	-74.38	23.36	94.52	-61.18	119.08	-0.25	-177.64
0.8	-14.47	-97.42	24.58	37.28	-59.15	-146.47	-0.26	-178.64
0.9	-11.56	-118.80	23.66	-11.00	-55.81	142.75	-0.23	-179.25
1.0	-10.52	-132.64	21.84	-48.10	-60.95	127.12	-0.18	179.91
1.1	-9.99	-141.31	20.03	-77.22	-59.10	123.90	-0.20	178.74
1.2	-9.30	-148.70	18.56	-103.23	-55.05	91.34	-0.31	177.68
1.3	-8.29	-156.47	17.59	-134.98	-59.13	75.75	-0.54	177.52
1.4	-7.61	-172.69	13.86	164.83	-60.46	28.97	-0.42	-179.29
1.5	-8.90	-179.34	-7.93	168.08	-60.25	139.43	0.00	177.98
1.6	-8.73	-179.96	-0.25	-124.11	-61.17	105.03	0.00	175.40
1.7	-8.01	178.25	-3.88	-105.38	-60.79	-15.56	-0.01	173.62
1.8	-6.52	166.88	8.44	-94.65	-54.41	102.86	-0.05	172.61
1.9	-7.02	159.51	6.45	-135.30	-55.63	101.46	-0.06	171.26
2.0	-6.68	152.38	7.26	-147.75	-54.53	83.73	-0.08	170.15
2.1	-6.43	147.14	6.07	-161.29	-50.50	92.59	-0.10	168.92
2.2	-6.16	141.61	5.15	-171.32	-65.26	75.70	-0.13	167.76
2.3	-5.82	136.31	4.33	179.36	-56.38	66.63	-0.14	166.47
2.4	-5.49	130.72	3.42	171.17	-58.04	50.34	-0.18	165.39
2.5	-5.14	125.51	2.64	163.71	-53.04	41.86	-0.19	164.28
2.6	-4.85	120.60	1.85	156.44	-54.07	76.60	-0.21	163.17
2.7	-4.53	115.85	1.09	149.48	-51.83	29.01	-0.19	162.13
2.8	-4.23	111.16	0.31	142.77	-50.32	49.31	-0.22	161.04
2.9	-3.96	106.92	-0.49	136.09	-55.49	20.49	-0.22	160.14
3.0	-3.66	102.78	-1.28	129.68	-51.50	36.03	-0.22	159.20
4.0	-3.32	72.10	-5.09	98.48	-52.66	21.72	-0.29	152.94
5.0	-2.38	48.11	-8.71	49.09	-50.87	13.93	-0.43	147.02
6.0	-2.35	14.04	-12.90	8.60	-52.41	-16.78	-0.29	145.06
7.0	-2.20	-5.81	-14.80	-30.00	-61.31	-8.69	-0.40	137.51
8.0	-2.51	-5.36	-16.01	-64.48	-54.15	-25.53	-0.49	125.29
9.0	-3.10	-3.46	-17.02	-101.85	-53.55	-25.19	-0.84	111.54
10.0	-3.36	-13.89	-18.41	-146.10	-52.82	-33.16	-1.27	100.70
11.0	-2.84	-34.58	-18.40	120.80	-43.41	-138.21	-8.78	168.54
12.0	-2.34	-52.71	-36.50	116.27	-58.92	-28.25	-0.41	116.94
13.0	-1.95	-58.77	-34.01	114.77	-56.13	-90.22	-0.42	98.03
14.0	-1.91	-60.09	-34.79	85.44	-52.85	-109.75	-0.49	83.45
15.0	-2.00	-72.30	-36.21	64.04	-47.41	-140.10	-0.68	71.15
16.0	-1.58	-92.88	-37.26	39.87	-45.73	159.61	-0.91	57.61
17.0	-1.17	-103.62	-38.07	1.30	-49.75	89.61	-1.00	43.27
18.0	-1.54	-111.59	-37.82	-10.03	-43.50	30.12	-1.22	27.85
19.0	-2.07	-122.05	-37.17	-46.22	-44.61	-36.27	-1.43	7.62
20.0	-1.89	-150.97	-37.71	-79.99	-46.79	-16.71	-1.76	-14.92

Note:

1. S-parameter is measured with deembedded reference plane at DUT RFin and RFout pins.

S-Parameter^[1] (Vdd = Vbias = 3.3 V, Vc1 = 2.8 V, Vc2 = 2.3 V, Vbyp = 3.3 V, T = 25° C, unmatched)

Freq (GHz)	S11 (dB)	S11 (Ang)	S21 (dB)	S21 (Ang)	S12 (dB)	S12 (Ang)	S22 (dB)	S22 (Ang)
0.1	-11.92	-6.46	-48.55	109.17	-54.25	53.49	-1.62	178.99
0.2	-12.39	-9.93	-33.65	-61.73	-55.57	140.56	-1.11	-177.83
0.3	-12.70	-11.65	-29.38	-145.07	-63.61	-73.29	-0.97	-177.48
0.4	-12.88	-14.50	-19.24	-123.81	-64.16	106.19	-0.85	-176.88
0.5	-12.82	-18.10	-8.02	-155.28	-61.93	179.01	-0.67	-176.15
0.6	-12.73	-21.02	1.36	155.44	-61.51	73.37	-0.48	-176.12
0.7	-12.59	-24.79	7.00	86.54	-60.27	74.41	-0.25	-177.05
0.8	-12.49	-29.28	7.75	15.52	-68.26	95.86	-0.15	-178.43
0.9	-12.65	-33.77	5.34	-36.90	-63.17	83.17	-0.16	-179.71
1.0	-12.59	-37.67	2.52	-73.44	-62.05	154.42	-0.20	179.29
1.1	-12.53	-42.10	0.01	-101.94	-57.98	30.33	-0.28	178.40
1.2	-12.71	-44.46	-2.09	-127.62	-63.04	169.78	-0.40	177.75
1.3	-12.85	-47.12	-3.84	-159.13	-61.24	44.82	-0.60	178.02
1.4	-13.01	-49.50	-8.51	144.69	-61.65	105.13	-0.38	-179.09
1.5	-13.15	-51.47	-30.57	151.02	-66.71	-127.89	0.00	178.02
1.6	-13.30	-54.44	-23.03	-141.05	-58.24	147.73	-0.01	175.46
1.7	-13.56	-56.71	-27.29	-120.74	-60.88	40.45	0.00	173.70
1.8	-13.87	-59.16	-16.15	-108.68	-56.87	29.32	-0.08	172.61
1.9	-14.20	-61.42	-18.93	-141.58	-57.25	99.98	-0.09	171.33
2.0	-14.61	-63.74	-18.08	-151.82	-60.59	74.54	-0.10	170.34
2.1	-15.13	-66.62	-19.69	-161.50	-55.17	134.56	-0.12	169.12
2.2	-15.65	-69.01	-21.04	-166.95	-60.74	27.34	-0.14	168.01
2.3	-16.31	-71.39	-22.04	-171.37	-59.26	71.07	-0.15	166.73
2.4	-17.16	-74.88	-23.34	-175.26	-54.76	63.63	-0.19	165.73
2.5	-18.11	-78.85	-24.28	-177.10	-56.27	83.31	-0.18	164.46
2.6	-19.28	-83.33	-24.97	-179.16	-54.42	121.59	-0.21	163.45
2.7	-20.47	-89.02	-25.87	-179.99	-57.21	105.17	-0.20	162.42
2.8	-22.05	-97.07	-26.41	179.07	-56.51	125.30	-0.22	161.28
2.9	-23.72	-109.43	-26.84	177.02	-55.13	70.86	-0.22	160.42
3.0	-25.06	-125.78	-27.28	175.94	-53.89	77.12	-0.21	159.49
4.0	-14.39	118.54	-28.14	175.83	-54.61	17.00	-0.29	153.21
5.0	-8.55	86.21	-27.12	130.33	-49.19	41.82	-0.42	147.31
6.0	-6.36	51.08	-28.82	89.39	-53.58	7.20	-0.29	145.41
7.0	-4.12	27.47	-28.73	51.54	-50.12	-3.00	-0.40	137.89
8.0	-2.71	24.22	-29.17	19.43	-51.47	-15.05	-0.50	125.81
9.0	-2.04	21.52	-29.17	-13.12	-48.10	-20.78	-0.84	112.13
10.0	-1.65	3.43	-29.59	-50.40	-47.51	-34.48	-1.26	101.34
11.0	-1.28	-24.96	-27.95	-138.22	-43.70	-119.57	-8.84	169.49
12.0	-0.94	-48.04	-45.36	-129.93	-66.05	-56.32	-0.40	117.68
13.0	-0.76	-57.21	-40.10	-130.14	-56.32	-124.01	-0.41	98.85
14.0	-0.85	-60.04	-37.42	-153.83	-50.73	-114.23	-0.49	84.34
15.0	-1.08	-72.84	-36.35	176.73	-47.97	-140.11	-0.68	72.11
16.0	-0.98	-92.97	-34.97	135.19	-43.88	173.82	-0.91	58.62
17.0	-0.84	-104.26	-36.08	85.82	-48.23	109.86	-1.00	44.15
18.0	-1.45	-111.75	-35.77	26.98	-42.81	32.34	-1.20	28.90
19.0	-1.88	-121.89	-37.46	-7.29	-44.81	-20.78	-1.45	9.00
20.0	-1.66	-151.08	-40.00	-8.99	-48.49	-9.16	-1.75	-13.86

Note:

1. S-parameter is measured with deembedded reference plane at DUT RFin and RFout pins.

Demonstration Board Top View (5 V BOM with OFDMA Modulation)

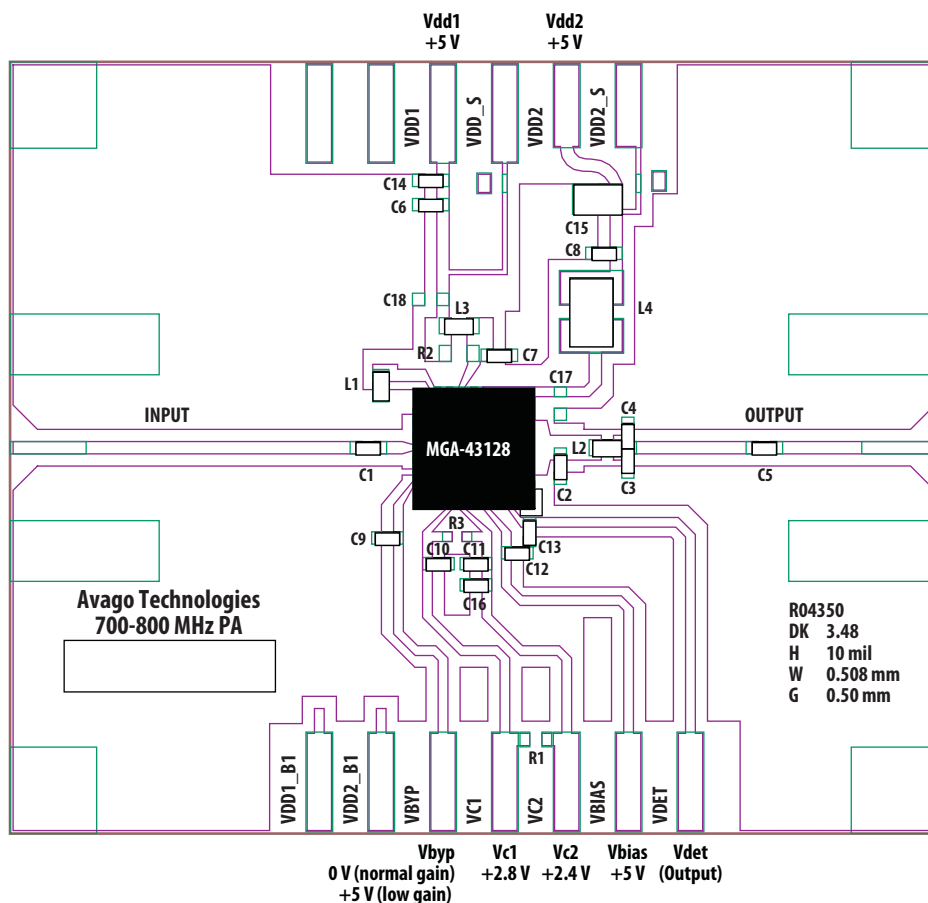

Figure 51. Demonstration Board Application Circuit for MGA-43128 Top View (5 V OFDMA BOM)

Bill of Materials

Component Label	Value	Part Number (Vendor)
C1, C5, C6, C8, C9, C10, C11, C12, C13	82 pF	GRM1555C1H820JZ01 (Murata)
C4, C7	8.2 pF	GJM1555C1H8R2DB01 (Murata)
C3	6.8 pF	GJM1555C1H6R8DB01 (Murata)
C2	5.6 pF	GJM1555C1H5R6DB01 (Murata)
C14	0.1 μ F	GRM155R61A104KA01 (Murata)
C15	4.7 μ F	GRM21BR60J475KA11 (Murata)
C16	1 nF	GRM155R71H102KA01 (Murata)
L1	2.4 nH	0402HP-2N4XJL (Coilcraft)
L2	1.9 nH	0402CS-1N9XJL (Coilcraft)
L3	1.0 nH	0402HP-1N0XJL (Coilcraft)
L4	5.6 nH	0805HQ-5N6XJL (Coilcraft)

Demonstration Board Top View (3.3 V BOM with SC-FDMA Modulation)

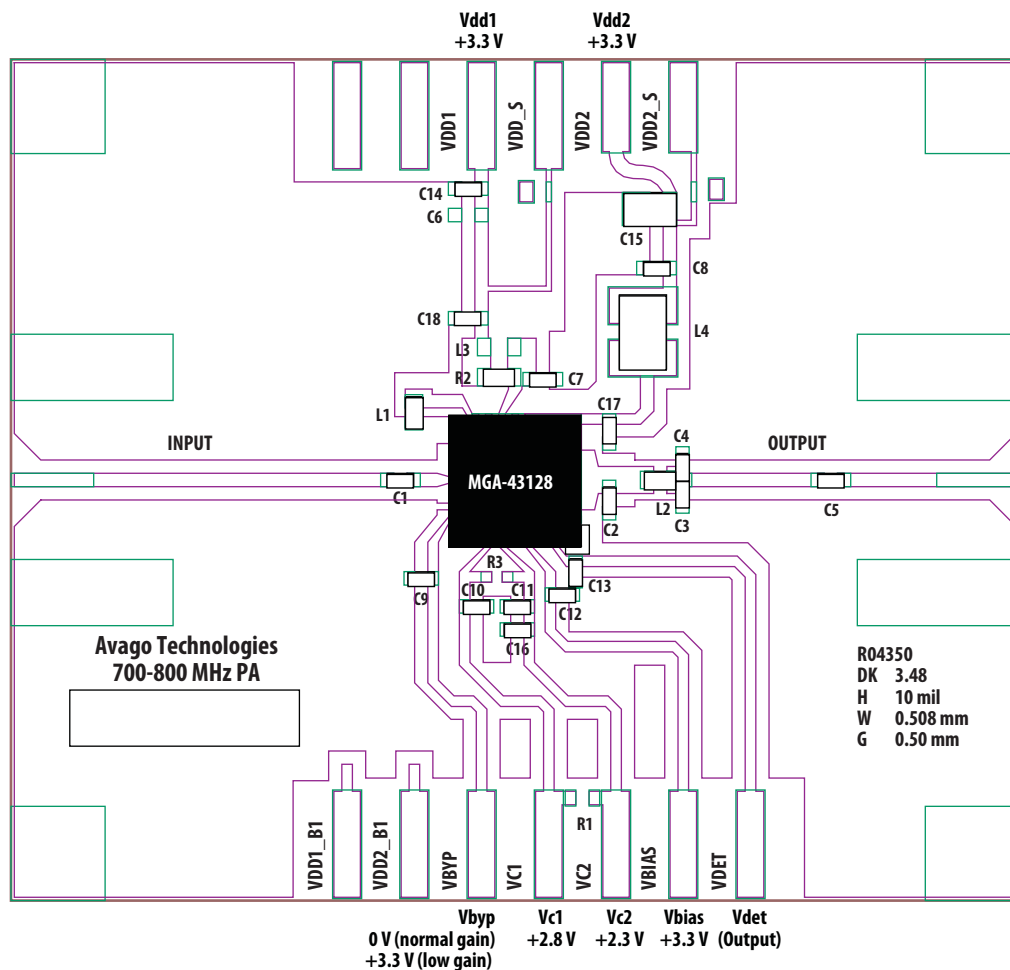

Figure 52. Demonstration Board Application Circuit for MGA-43128 Top View (3.3 V SC-FDMA BOM)

Bill of Materials

Component Label	Value	Part Number (Vendor)
C1, C5, C8, C9, C10, C11, C12, C13	82 pF	GRM1555C1H820JZ01 (Murata)
C2	7.5pF	GJM1555C1H7R5DB01 (Murata)
C3	6.2 pF	GJM1555C1H6R2DB01 (Murata)
C4	8.2 pF	GJM1555C1H8R2DB01 (Murata)
C7	5.6 pF	GJM1555C1H5R6DB01 (Murata)
C14	0.1 μ F	GRM155R61A104KA01 (Murata)
C15	4.7 μ F	GRM21BR60J475KA11 (Murata)
C16	1 nF	GRM155R71H102KA01 (Murata)
C17	12 pF	GJM1555C1H120JB01 (Murata)
C18	220 pF	GRM1555C1H221JA01 (Murata)
L1	6.8 nH	0402HP-6N8XJL (Coilcraft)
L2	1.9 nH	0402CS-1N9XJL (Coilcraft)
L4	5.6 nH	0805HQ-5N6XJL (Coilcraft)
R2	0 Ohm	RK73Z1ETTP (KOA)

Application Schematic (5 V Bias with OFDMA Modulation)

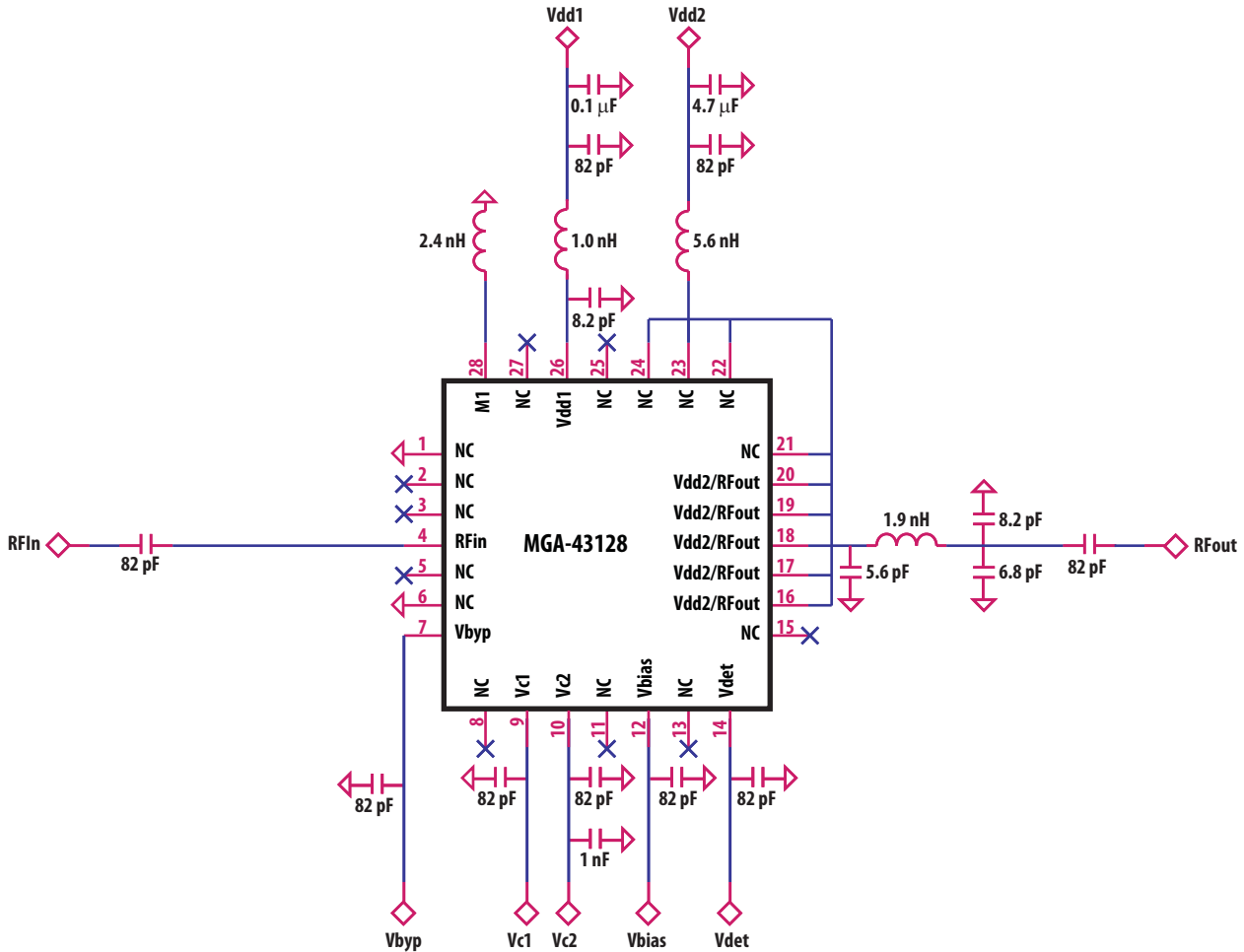

Figure 53. Application Schematic in Demonstration Board (5 V OFDMA BOM)

Notes:

- In normal gain mode operation, $V_{byp} = 0\text{ V}$. V_{c1} , V_{c2} are bias pins that are used to set the bias conditions to the 2 internal gain stages of the PA.
- Typical quiescent current distribution with $V_{dd1} = V_{dd2} = 5\text{ V}$, $V_{byp} = 0\text{ V}$, $V_{c1} = 2.8\text{ V}$, $V_{c2} = 2.4\text{ V}$ is:
 - $I_{dd1} = 45\text{ mA}$
 - $I_{dd2} = 325\text{ mA}$
 - $I_{bias} = 13\text{ mA}$
- Low-gain mode is enabled by setting V_{byp} pin to 5 V. This reduces gain of the amplifier by 18 dB.
- Modulated signal measurements are made with Agilent N9020A MXA Signal Analyzer and Agilent ESG4438C signal generator with N7624B option using the following test conditions:
 - Signal format: LTE 3GPP.TS 36.104, OFDMA
 - Modulation bandwidth: 10 MHz
 Residual distortion of signal generator: (0.6-0.8)%. This distortion is included in the overall EVM data in the datasheet.
- Typical operating voltages and currents:
 - Normal gain mode: $V_{dd1} = V_{dd2} = V_{bias} = 5\text{ V}$. $V_{byp} = 0\text{ V}$. $I_q(\text{total}) = 370\text{ mA}$.
 - Bypass mode: $V_{dd2} = V_{dd1} = V_{bias} = 5\text{ V}$. $V_{byp} = 5\text{ V}$. $I_q(\text{total}) = 370\text{ mA}$.
- $V_{dd1/2}$ are shown as separate supplies with individual bypass capacitors. This yields the most stable configuration. If a common power supply line is used, proper broadband bypass decoupling is recommended to reduce common mode feedback through the supply line.

Application Schematic (3.3 V Bias with SC-FDMA Modulation)

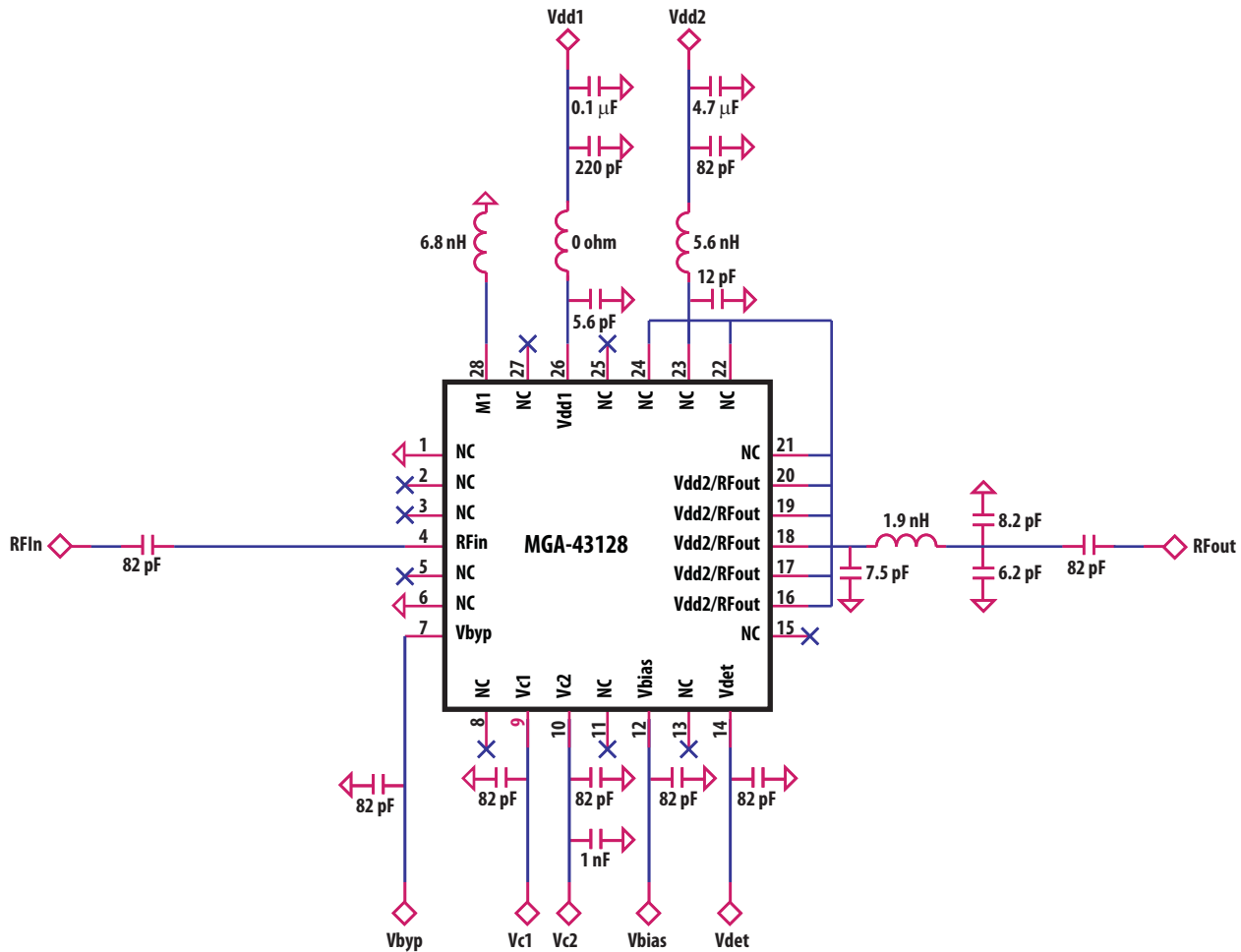
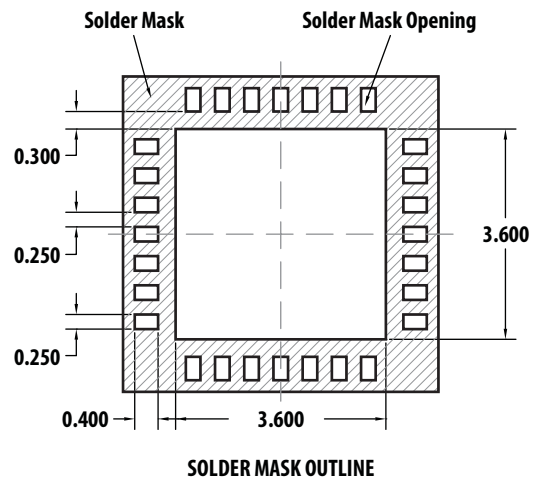
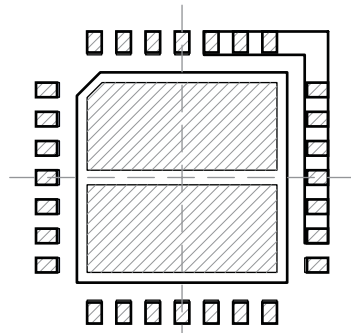
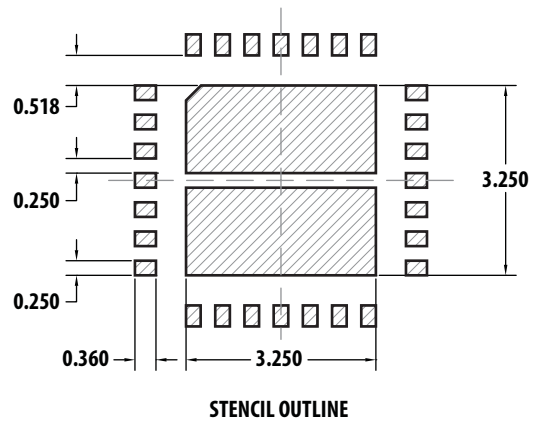
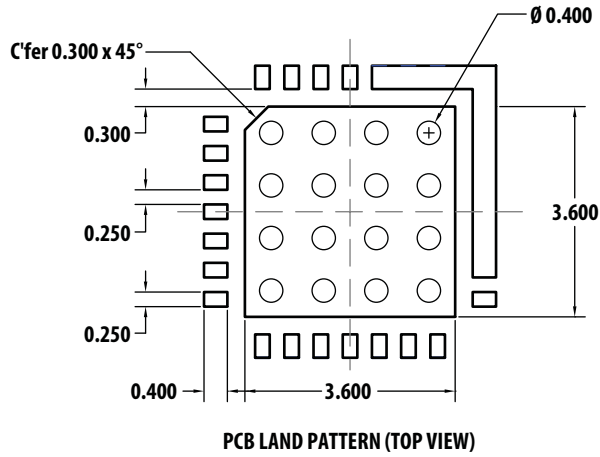

Figure 54. Application Schematic in Demonstration Board (3.3 V SC-FDMA BOM)

Notes:

1. In normal gain mode operation, $V_{byp} = 0\text{ V}$. V_{c1} , V_{c2} are bias pins that are used to set the bias conditions to the 2 internal gain stages of the PA.
2. Typical quiescent current distribution with $V_{dd1} = V_{dd2} = 3.3\text{ V}$, $V_{byp} = 0\text{ V}$, $V_{c1} = 2.8\text{ V}$, $V_{c2} = 2.3\text{ V}$ is:
 - a. $I_{dd1} = 32\text{ mA}$
 - b. $I_{dd2} = 218\text{ mA}$
 - c. $I_{bias} = 12\text{ mA}$
3. Low-gain mode is enabled by setting V_{byp} pin to 3.3 V. This reduces gain of the amplifier by 16.5 dB.
4. Modulated signal measurements are made with Agilent N9020A MXA Signal Analyzer and Agilent ESG4438C signal generator with N7624B option using the following test conditions:
 - Signal format: LTE 3GPP.TS 36.101, SC-FDMA
 - Modulation bandwidth: 10 MHz
Residual distortion of signal generator: (0.6-0.8)%. This distortion is included in the overall EVM data in the datasheet.
5. Typical operating voltages and currents:
 - d. Normal gain mode: $V_{dd1} = V_{dd2} = V_{bias} = 3.3\text{ V}$. $V_{byp} = 0\text{ V}$. $I_{q(\text{total})} = 260\text{ mA}$.
 - e. Bypass mode: $V_{dd2} = V_{dd1} = V_{bias} = 3.3\text{ V}$. $V_{byp} = 3.3\text{ V}$. $I_{q(\text{total})} = 260\text{ mA}$.
6. $V_{dd1/2}$ are shown as separate supplies with individual bypass capacitors. This yields the most stable configuration. If a common power supply line is used, proper broadband bypass decoupling is recommended to reduce common mode feedback through the supply line.

PCB Land Patterns and Stencil Design



(All dimensions in mm)

QFN 5.0 x 5.0 x 0.85 mm³ 28-Lead Package Dimensions

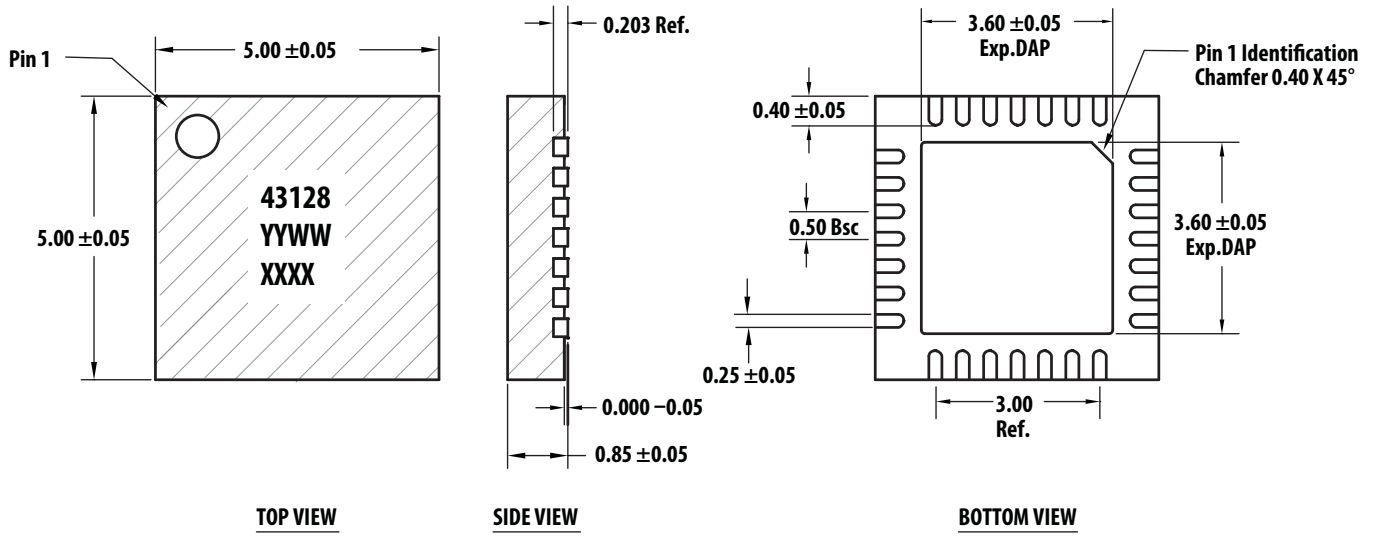

Notes:

1. All dimensions are in millimeters
2. Dimensions are inclusive of plating
3. Dimensions are exclusive of mold flash and metal burr.

Part Number Ordering Information

Part Number	Qty	Container
MGA-43128-BLKG	100	Antistatic Bag
MGA-43128-TR1G	1000	7" Reel

Device Orientation

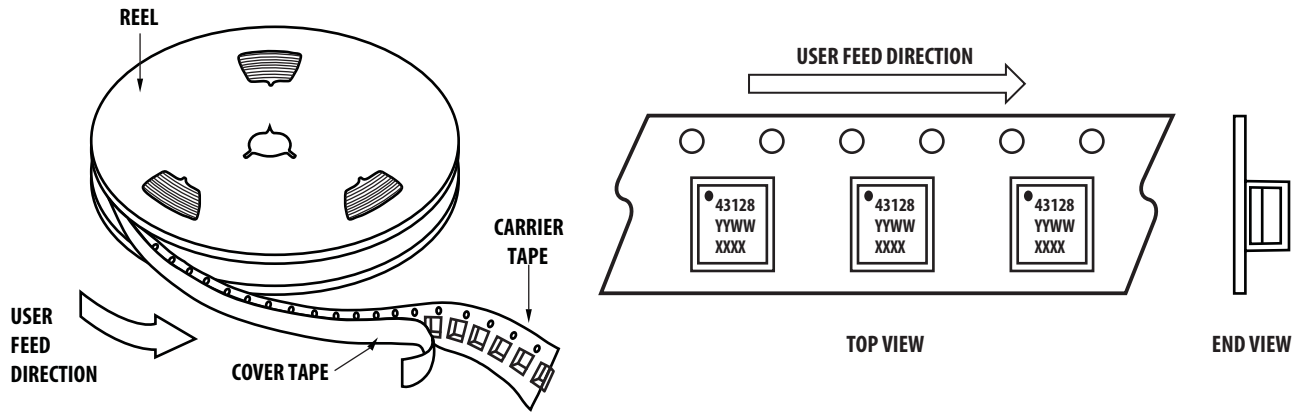

Tape Dimensions

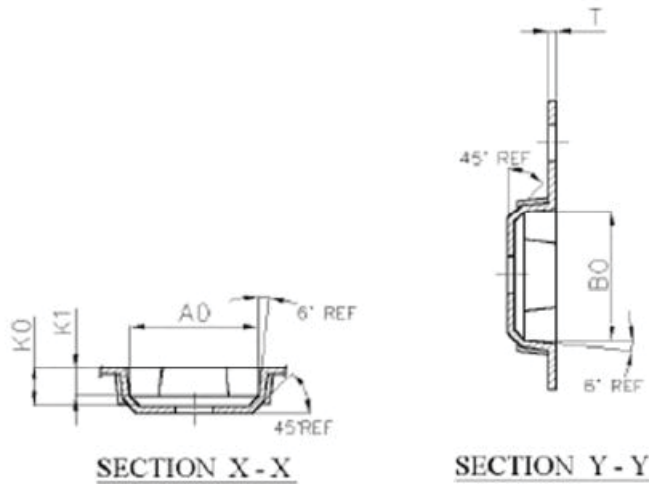
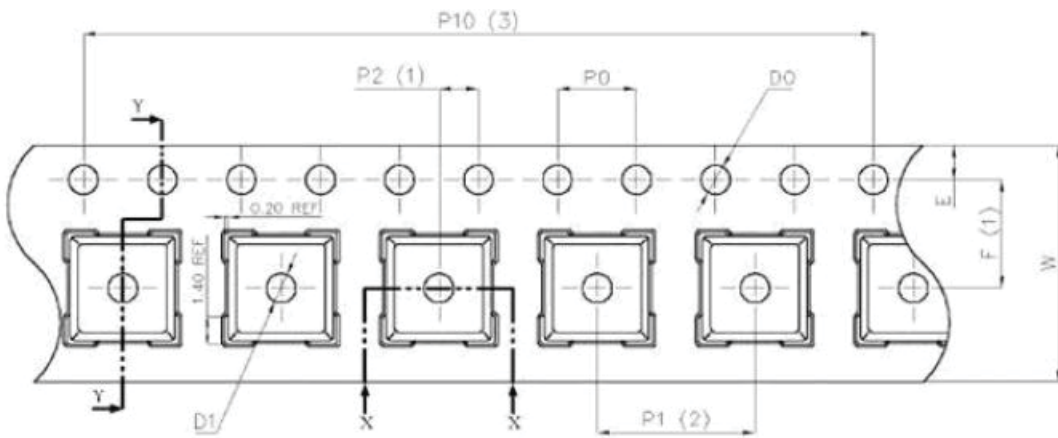

Dimension List			
Annote	Milimeter	Annote	Milimeter
A0	5.40±0.10	P0	4.00±0.10
B0	5.40±0.10	P2	2.00±0.10
D0	1.50 ^{+0.10} ₋₀	P10	40.00±0.20
D1	1.60±0.10	E	1.75±0.10
K0	1.90±0.10	F	5.50±0.10
K1	1.50±0.10	T	0.30±0.03
P1	8.00±0.10	W	12.00±0.30

Reel Dimensions (7 inch reel)

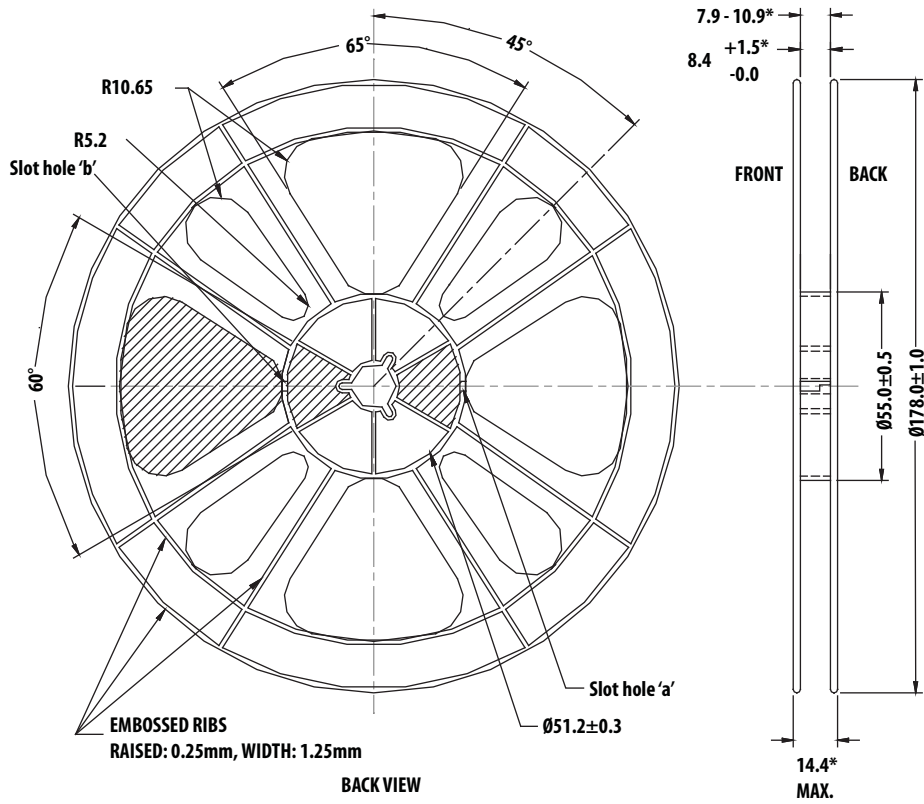
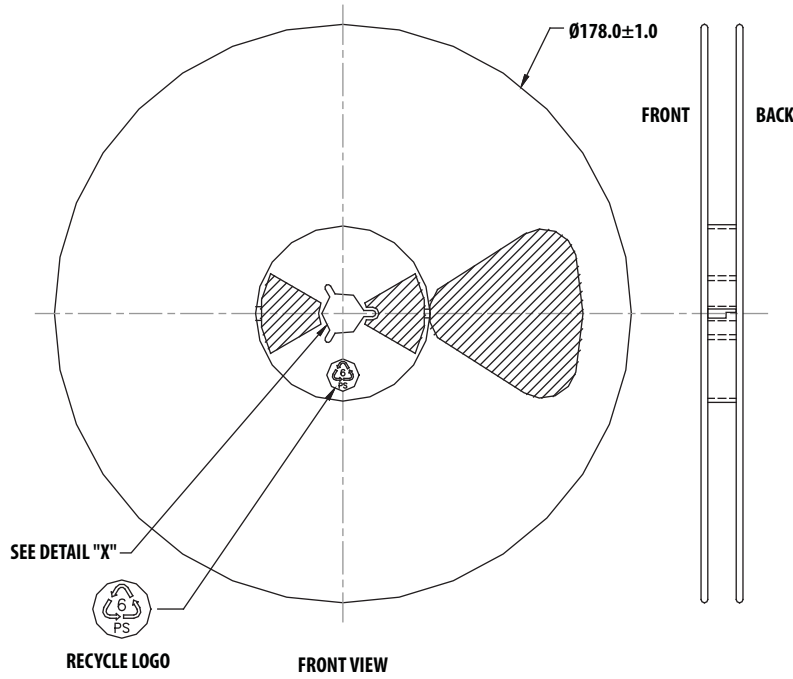

For product information and a complete list of distributors, please go to our web site: www.avagotech.com

Avago, Avago Technologies, and the A logo are trademarks of Avago Technologies in the United States and other countries. Data subject to change. Copyright © 2005-2012 Avago Technologies. All rights reserved. AV02-3246EN - February 29, 2012

