



HD/SD SDI Receiver, with Integrated Adaptive Cable Equalizer complete with SMPTE Audio and Video Processing

Key Features

- Operation at 1.485Gb/s, 1.485/1.001Gb/s and 270Mb/s
- Supports SMPTE 292M, SMPTE 259M-C and DVB-ASI
- Integrated adaptive cable equalizer
- Typical equalized length of Belden 1694A cable:
 - ◆ 230m at 1.485Gb/s
 - ◆ 440m at 270Mb/s
- Integrated Reclocker with low phase noise, integrated VCO
- Serial digital reclocked, or non-reclocked output
- Integrated audio de-embedder for 8 channels of 48kHz audio
- Integrated audio clock generator
- Ancillary data extraction
- Parallel data bus selectable as either 20-bit or 10-bit
- Comprehensive error detection and correction features
- Output H, V, F or CEA 861 Timing Signals
- 1.2V digital core power supply, 1.2V and 3.3V analog power supplies, and selectable 1.8V or 3.3V I/O power supply
- GSPI Host Interface
- -20°C to +85°C operating temperature range
- Low power operation (typically 480mW)
- Small 11mm x 11mm 100-ball BGA package
- Pb-free and ROHS compliant

Errata

Refer to Errata document entitled **GS1670/GS1671 Errata** for this device (document number 53878).

Applications

Application: 1080p30 or 720p60 Monitor

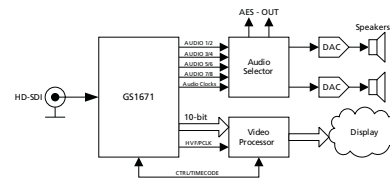

Application: Multi-format Downconverter

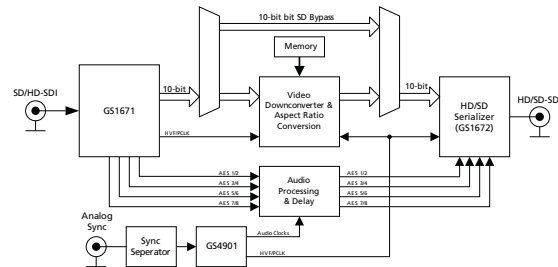

Application: Multi-input Video Monitoring System

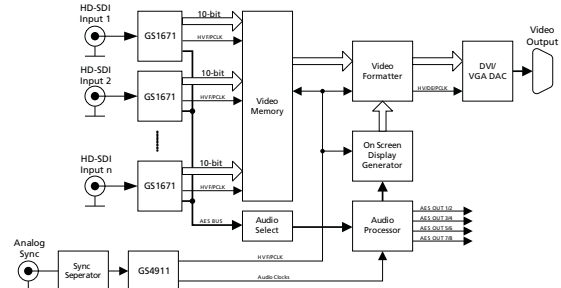

Application: Multi-format Audio De-embedder Module

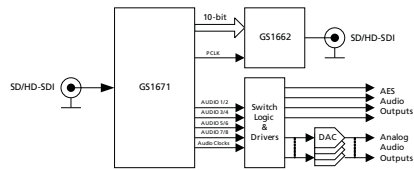

Application: Multi-format Digital VTR/Video Server

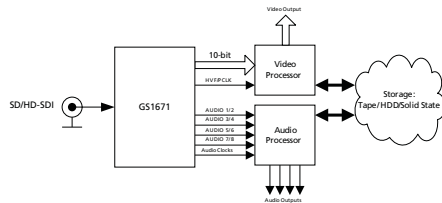

Description

The GS1671 is a multi-rate SDI integrated Receiver which includes complete SMPTE processing, as per SMPTE 292M and SMPTE 259M-C. The SMPTE processing features can be bypassed to support signals with other coding schemes.

The GS1671 integrates Gennum's adaptive cable equalizer technology, achieving unprecedented cable lengths and jitter tolerance. It features DC restoration to compensate for the DC content of SMPTE pathological signals.

The device features an Integrated Reclocker with an internal VCO and a wide Input Jitter Tolerance (IJT) of 0.7UI.

A serial digital loop-through output is provided, which can be configured to output either reclocked or non-reclocked serial digital data. The serial digital output can be connected to an external cable driver.

The device operates in one of four basic modes: SMPTE mode, DVB-ASI mode, Data-Through mode or Standby mode.

In SMPTE mode (the default operating mode), the GS1671 performs full SMPTE processing, and features a number of data integrity checks and measurement capabilities.

The device also supports ancillary data extraction, and can provide entire ancillary data packets through host-accessible registers. It also provides a variety of other packet detection and error handling features. All of these processing features are optional, and may be individually enabled or disabled through register programming.

In DVB-ASI mode, sync word detection, alignment and 8b/10b decoding is applied to the received data stream.

In Data-Through mode all forms of SMPTE and DVB-ASI processing are disabled, and the device can be used as a simple serial to parallel converter.

The device can also operate in a lower power Standby mode. In this mode, no signal processing is carried out and the parallel output is held static.

Parallel data outputs are provided in 20-bit or 10-bit format for HD and SD video rates, with a variety of mapping options. As such, this parallel bus can interface directly with video processor ICs, and output data can be multiplexed onto 10 bits for a low pin count interface.

Up to eight channels (two audio groups) of serial digital audio may be extracted from the video data stream, in accordance with SMPTE 272M-C and SMPTE 299M.

The output audio formats supported by the device include AES/EBU and I²S, and two other industry standard serial digital formats. A variety of audio processing features are provided to ease implementation. Audio clocks are internally generated and provided by the device.

Functional Block Diagram

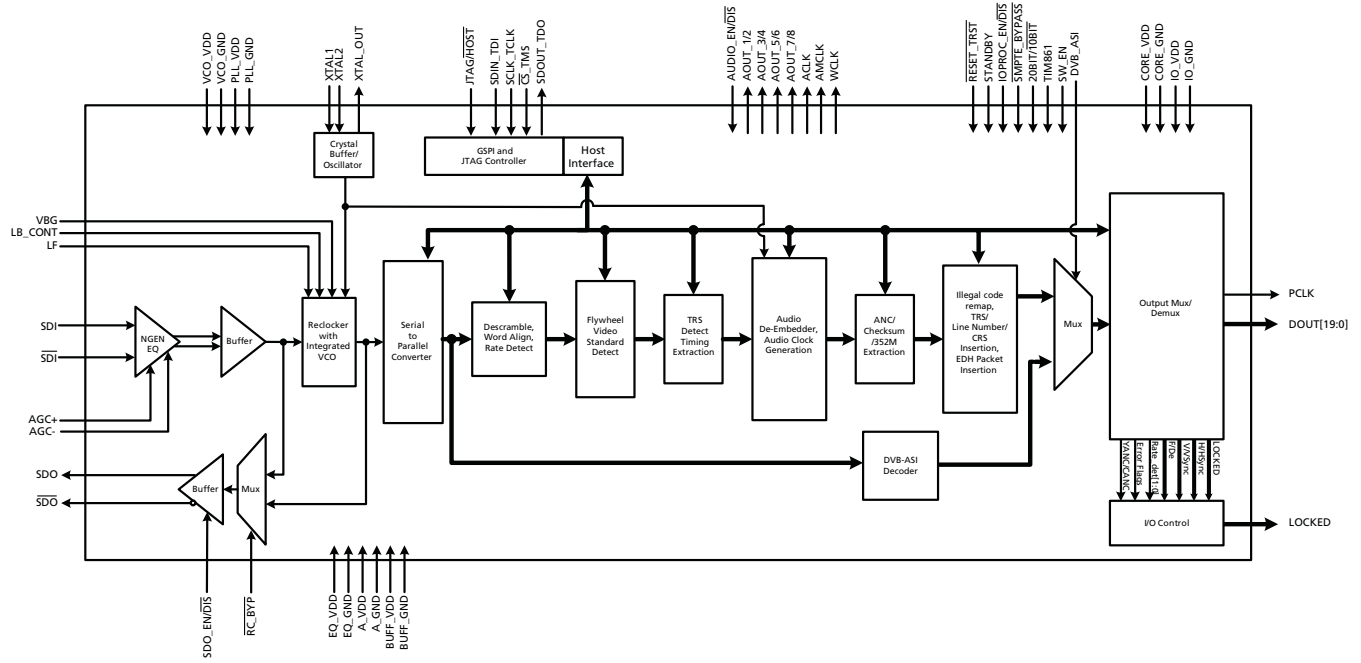

GS1671 Functional Block Diagram

Contents

Key Features	1
Errata.....	1
Applications.....	1
Description.....	2
Functional Block Diagram	3
1. Pin Out.....	8
1.1 Pin Assignment	8
1.2 Pin Descriptions	8
2. Electrical Characteristics	16
2.1 Absolute Maximum Ratings	16
2.2 Recommended Operating Conditions	16
2.3 DC Electrical Characteristics	17
2.4 AC Electrical Characteristics	19
3. Input/Output Circuits	23
4. Detailed Description.....	26
4.1 Functional Overview	26
4.2 Serial Digital Input	27
4.2.1 Integrated Adaptive Cable Equalizer.....	27
4.3 Serial Digital Loop-Through Output	28
4.4 Serial Digital Reclocker	29
4.4.1 PLL Loop Bandwidth	29
4.5 External Crystal/Reference Clock	30
4.6 Lock Detect	31
4.6.1 Asynchronous Lock	31
4.6.2 Signal Interruption.....	32
4.7 SMPTE Functionality	32
4.7.1 Descrambling and Word Alignment	32
4.8 Parallel Data Outputs	33
4.8.1 Parallel Data Bus Buffers.....	33
4.8.2 Parallel Output in SMPTE Mode	35
4.8.3 Parallel Output in DVB-ASI Mode	35
4.8.4 Parallel Output in Data-Through Mode	36
4.8.5 Parallel Output Clock (PCLK).....	36
4.9 Timing Signal Generator	37
4.9.1 Manual Switch Line Lock Handling	37
4.9.2 Automatic Switch Line Lock Handling.....	38
4.10 Programmable Multi-function Outputs	40
4.11 H:V:F Timing Signal Generation	41
4.11.1 CEA-861 Timing Generation	42
4.12 Automatic Video Standards Detection	48
4.13 Data Format Detection & Indication	50
4.14 EDH Detection	51
4.14.1 EDH Packet Detection	51
4.14.2 EDH Flag Detection	51

4.15 Video Signal Error Detection & Indication	52
4.15.1 TRS Error Detection	54
4.15.2 Line Based CRC Error Detection	54
4.15.3 EDH CRC Error Detection.....	54
4.15.4 HD Line Number Error Detection	55
4.16 Ancillary Data Detection & Indication	55
4.16.1 Programmable Ancillary Data Detection.....	56
4.16.2 SMPTE 352M Payload Identifier	57
4.16.3 Ancillary Data Checksum Error	57
4.16.4 Video Standard Error	58
4.17 Signal Processing	58
4.17.1 TRS Correction & Insertion.....	59
4.17.2 Line Based CRC Correction & Insertion	59
4.17.3 Line Number Error Correction & Insertion	60
4.17.4 ANC Data Checksum Error Correction & Insertion	60
4.17.5 EDH CRC Correction & Insertion	60
4.17.6 Illegal Word Re-mapping	60
4.17.7 TRS and Ancillary Data Preamble Remapping.....	61
4.17.8 Ancillary Data Extraction.....	61
4.18 Audio De-embedder	65
4.18.1 Serial Audio Data I/O Signals.....	65
4.18.2 Serial Audio Data Format Support	67
4.18.3 Audio Processing.....	71
4.18.4 Error Reporting	77
4.19 GSPI - HOST Interface	78
4.19.1 Command Word Description	78
4.19.2 Data Read or Write Access.....	79
4.19.3 GSPI Timing.....	80
4.20 Host Interface Register Maps	82
4.20.1 Video Core Registers.....	82
4.20.2 SD Audio Core Registers.....	91
4.20.3 HD Audio Core Registers.....	106
4.21 JTAG Test Operation	121
4.22 Device Power-up	123
4.23 Device Reset	123
4.24 Standby Mode	123
5. Application Reference Design	124
5.1 High Gain Adaptive Cable Equalizers	124
5.2 PCB Layout	124
5.3 Typical Application Circuit	125
6. References & Relevant Standards	126
7. Package & Ordering Information	127
7.1 Package Dimensions	127
7.2 Packaging Data	128
7.3 Marking Diagram	128
7.4 Solder Reflow Profiles	129
7.5 Ordering Information	129
Revision History	129

List of Figures

Figure 3-1: Digital Input Pin with Schmitt Trigger	23
Figure 3-2: Bidirectional Digital Input/Output Pin.....	23
Figure 3-3: Bidirectional Digital Input/Output Pin with programmable drive strength.....	24
Figure 3-4: XTAL1/XTAL2/XTAL-OUT	24
Figure 3-5: VBG	24
Figure 3-6: LB_CONT	25
Figure 3-7: Loop Filter	25
Figure 3-8: SDO/ $\overline{\text{SDO}}$	25
Figure 3-9: Equalizer Input Equivalent Circuit	25
Figure 4-1: GS1671 Integrated EQ Block Diagram	28
Figure 4-2: 27MHz Clock Sources	30
Figure 4-3: PCLK to Data and Control Signal Output Timing - SDR Mode 1	33
Figure 4-4: PCLK to Data and Control Signal Output Timing - SDR Mode 2	34
Figure 4-5: Switch Line Locking on a Non-Standard Switch Line	38
Figure 4-6: H:V:F Output Timing - HDTV 20-bit Mode	41
Figure 4-7: H:V:F Output Timing - HDTV 10-bit Mode	41
Figure 4-8: H:V:F Output Timing - HD 20-bit Output Mode	42
Figure 4-9: H:V:F Output Timing - HD 10-bit Output Mode	42
Figure 4-10: H:V:F Output Timing - SD 20-bit Output Mode	42
Figure 4-11: H:V:F Output Timing - SD 10-bit Output Mode	42
Figure 4-12: H:V:DE Output Timing 1280 x 720p @ 59.94/60 (Format 4)	44
Figure 4-13: H:V:DE Output Timing 1920 x 1080i @ 59.94/60 (Format 5)	44
Figure 4-14: H:V:DE Output Timing 720 (1440) x 480i @ 59.94/60 (Format 6&7)	45
Figure 4-15: H:V:DE Output Timing 1280 x 720p @ 50 (Format 19)	45
Figure 4-16: H:V:DE Output Timing 1920 x 1080i @ 50 (Format 20)	46
Figure 4-17: H:V:DE Output Timing 720 (1440) x 576 @ 50 (Format 21 & 22)	46
Figure 4-18: H:V:DE Output Timing 1920 x 1080p @ 23.94/24 (Format 32)	47
Figure 4-19: H:V:DE Output Timing 1920 x 1080p @ 25 (Format 33)	47
Figure 4-20: H:V:DE Output Timing 1920 x 1080p @ 29.97/30 (Format 34)	48
Figure 4-21: Y/1ANC and C/2ANC Signal Timing	56
Figure 4-22: Ancillary Data Extraction - Step A	62
Figure 4-23: Ancillary Data Extraction - Step B	63
Figure 4-24: Ancillary Data Extraction - Step C	63
Figure 4-25: Ancillary Data Extraction - Step D	64
Figure 4-26: ACLK to Data Signal Output Timing	66
Figure 4-27: I ² S Audio Output Format	67
Figure 4-28: AES/EBU Audio Output Format	67
Figure 4-29: Serial Audio, Left Justified, MSB First	68
Figure 4-30: Serial Audio, Left Justified, LSB First	68
Figure 4-31: Serial Audio, Right Justified, MSB First	68
Figure 4-32: Serial Audio, Right Justified, LSB First	68
Figure 4-33: AES/EBU Audio Output to Bit Clock Timing	68
Figure 4-34: ECC 24-bit Array and Examples	71
Figure 4-35: Sample Distribution over 5 Video Frames (525-line Systems)	72
Figure 4-36: Audio Buffer After Initial 26 Sample Write	73
Figure 4-37: Audio Buffer Pointer Boundary Checking	73
Figure 4-38: GSPI Application Interface Connection	78
Figure 4-39: Command Word Format	78
Figure 4-40: Data Word Format	79
Figure 4-41: Write Mode	80
Figure 4-42: Read Mode	80

Figure 4-43: GSPI Time Delay	80
Figure 4-44: In-Circuit JTAG	122
Figure 4-45: System JTAG	122
Figure 4-46: Reset Pulse	123
Figure 7-1: Pb-free Solder Reflow Profile	129

List of Tables

Table 1-1: Pin Descriptions	8
Table 2-1: Absolute Maximum Ratings.....	16
Table 2-2: Recommended Operating Conditions.....	16
Table 2-3: DC Electrical Characteristics	17
Table 2-4: AC Electrical Characteristics	19
Table 4-1: Serial Digital Output.....	28
Table 4-2: PLL Loop Bandwidth	29
Table 4-3: Input Clock Requirements.....	30
Table 4-4: Lock Detect Conditions.....	31
Table 4-5: GS1671 Output Video Data Format Selections.....	34
Table 4-6: GS1671 PCLK Output Rates	36
Table 4-7: Switch Line Position for Digital Systems	39
Table 4-8: Output Signals Available on Programmable Multi-Function Pins.....	40
Table 4-9: Supported CEA-861 Formats.....	43
Table 4-10: CEA861 Timing Formats	43
Table 4-11: Supported Video Standard Codes	48
Table 4-12: Data Format Register Codes	50
Table 4-13: Error Status Register and Error Mask Register	53
Table 4-14: IOPROC_DISABLE Register Bits	59
Table 4-15: Serial Audio Pin Descriptions	65
Table 4-16: Audio Output Formats.....	67
Table 4-17: Audio Data Packet Detect Register	69
Table 4-18: Audio Group DID Host Interface Settings.....	70
Table 4-19: Audio Data and Control Packet DID Setting Register	70
Table 4-20: Audio Buffer Pointer Offset Settings	74
Table 4-21: Audio Channel Mapping Codes	74
Table 4-22: Audio Sample Word Lengths	75
Table 4-23: Audio Channel Status Information Registers	76
Table 4-24: Audio Channel Status Block for Regenerate Mode Default Settings	76
Table 4-25: Audio Mute Control Bits	77
Table 4-26: GSPI Time Delay.....	80
Table 4-27: GSPI Timing Parameters (50% levels; 3.3V or 1.8V operation)	81
Table 4-28: Video Core Configuration and Status Registers.....	82
Table 4-29: SD Audio Core Configuration and Status Registers.....	91
Table 4-30: HD Audio Core Configuration and Status Registers.....	106
Table 4-31: ANC Extraction FIFO Access Registers.....	121
Table 7-1: Packaging Data.....	128

1. Pin Out

1.1 Pin Assignment

	1	2	3	4	5	6	7	8	9	10
A	VBG	LF	LB_CONT	VCO_VDD	STAT0	STAT1	IO_VDD	PCLK	DOUT18	DOUT17
B	A_VDD	PLL_VDD	RSV	VCO_GND	STAT2	STAT3	IO_GND	DOUT19	DOUT16	DOUT15
C	SDI	A_GND	PLL_VDD	PLL_VDD	STAT4	STAT5	$\overline{\text{RESET}}_{\text{TRST}}$	DOUT12	DOUT14	DOUT13
D	$\overline{\text{SDI}}$	A_GND	A_GND	PLL_GND	CORE_GND	CORE_VDD	SW_EN	JTAG/HOST	IO_GND	IO_VDD
E	EQ_VDD	EQ_GND	A_GND	PLL_GND	CORE_GND	CORE_VDD	SDOUT_TDO	SDIN_TDI	DOUT10	DOUT11
F	AGCP	RSV	A_GND	PLL_GND	CORE_GND	CORE_VDD	$\overline{\text{CS}}_{\text{TMS}}$	SCLK_TCK	DOUT8	DOUT9
G	AGCN	A_GND	$\overline{\text{RC}}_{\text{BYP}}$	CORE_GND	CORE_GND	CORE_VDD	$\overline{\text{SMPTE}}_{\text{BYPASS}}$	DVB_ASI	IO_GND	IO_VDD
H	BUFF_VDD	BUFF_GND	AUDIO_EN/DIS	WCLK	TIM_861	XTAL_OUT	20bit/10bit	IOPROC_EN/DIS	DOUT6	DOUT7
J	SDO	SDO_EN/DIS	AOUT_1/2	ACLK	AOUT_5/6	XTAL2	IO_GND	DOUT1	DOUT4	DOUT5
K	$\overline{\text{SDO}}$	STANDBY	AOUT_3/4	AMCLK	AOUT_7/8	XTAL1	IO_VDD	DOUT0	DOUT2	DOUT3

1.2 Pin Descriptions

Table 1-1: Pin Descriptions

Pin Number	Name	Timing	Type	Description
A1	VBG		Analog Input	Band Gap voltage filter connection.
A2	LF		Analog Input	Loop Filter component connection.
A3	LB_CONT		Analog Input	Connection for loop bandwidth control resistor.
A4	VCO_VDD		Input Power	POWER pin for the VCO. Connect to 1.2V±5% analog supply followed by a RC filter (see 5. Application Reference Design). A 105Ω 1% resistor must be used in the RC filter circuit. VCO_VDD is nominally 0.7V.

Table 1-1: Pin Descriptions (Continued)

Pin Number	Name	Timing	Type	Description																										
A5, A6, B5, B6, C5, C6	STAT[0:5]		Output	<p>MULTI-FUNCTIONAL OUTPUT PORT.</p> <p>Please refer to the Output Logic parameters in the DC Electrical Characteristics table for logic level threshold and compatibility.</p> <p>Each of the STAT [0:5] pins can be configured individually to output one of the following signals:</p> <table border="1"> <thead> <tr> <th>Signal</th> <th>Default</th> </tr> </thead> <tbody> <tr> <td>H/HSYNC</td> <td>STAT0</td> </tr> <tr> <td>V/VSYNC</td> <td>STAT1</td> </tr> <tr> <td>F/DE</td> <td>STAT2</td> </tr> <tr> <td>LOCKED</td> <td>STAT3</td> </tr> <tr> <td>Y/1ANC</td> <td>STAT4</td> </tr> <tr> <td>C/2ANC</td> <td>–</td> </tr> <tr> <td>DATA ERROR</td> <td>STAT5</td> </tr> <tr> <td>VIDEO ERROR</td> <td>–</td> </tr> <tr> <td>AUDIO ERROR</td> <td>–</td> </tr> <tr> <td>EDH DETECTED</td> <td>–</td> </tr> <tr> <td>CARRIER DETECT</td> <td>–</td> </tr> <tr> <td>RATE_DET</td> <td>–</td> </tr> </tbody> </table>	Signal	Default	H/HSYNC	STAT0	V/VSYNC	STAT1	F/DE	STAT2	LOCKED	STAT3	Y/1ANC	STAT4	C/2ANC	–	DATA ERROR	STAT5	VIDEO ERROR	–	AUDIO ERROR	–	EDH DETECTED	–	CARRIER DETECT	–	RATE_DET	–
Signal	Default																													
H/HSYNC	STAT0																													
V/VSYNC	STAT1																													
F/DE	STAT2																													
LOCKED	STAT3																													
Y/1ANC	STAT4																													
C/2ANC	–																													
DATA ERROR	STAT5																													
VIDEO ERROR	–																													
AUDIO ERROR	–																													
EDH DETECTED	–																													
CARRIER DETECT	–																													
RATE_DET	–																													
A7, D10, G10, K7	IO_VDD		Input Power	POWER connection for digital I/O. Connect to 3.3V or 1.8V DC digital.																										
A8	PCLK		Output	<p>PARALLEL DATA BUS CLOCK</p> <p>Please refer to the Output Logic parameters in the DC Electrical Characteristics table for logic level threshold and compatibility.</p> <table border="1"> <tbody> <tr> <td>HD 10-bit mode</td> <td>PCLK @ 148.5 or 148.5/1.001MHz</td> </tr> <tr> <td>HD 20-bit mode</td> <td>PCLK @ 74.25 or 74.25/1.001MHz</td> </tr> <tr> <td>SD 10-bit mode</td> <td>PCLK @ 27MHz</td> </tr> <tr> <td>SD 20-bit mode</td> <td>PCLK @ 13.5MHz</td> </tr> </tbody> </table>	HD 10-bit mode	PCLK @ 148.5 or 148.5/1.001MHz	HD 20-bit mode	PCLK @ 74.25 or 74.25/1.001MHz	SD 10-bit mode	PCLK @ 27MHz	SD 20-bit mode	PCLK @ 13.5MHz																		
HD 10-bit mode	PCLK @ 148.5 or 148.5/1.001MHz																													
HD 20-bit mode	PCLK @ 74.25 or 74.25/1.001MHz																													
SD 10-bit mode	PCLK @ 27MHz																													
SD 20-bit mode	PCLK @ 13.5MHz																													

Table 1-1: Pin Descriptions (Continued)

Pin Number	Name	Timing	Type	Description
A9, A10, B8, B9, B10, C8, C9, C10, E9, E10	DOUT18, 17, 19, 16, 15, 12, 14, 13, 10, 11		Output	<p>PARALLEL DATA BUS</p> <p>Please refer to the Output Logic parameters in the DC Electrical Characteristics table for logic level threshold and compatibility.</p> <hr/> <p>20-bit mode 20bit/10bit = HIGH</p> <p>SMPTE mode ($\overline{\text{SMPTE_BYPASS}}$ = HIGH and DVB_ASI = LOW): Luma data output for SD and HD data rates</p> <p>DVB-ASI mode ($\overline{\text{SMPTE_BYPASS}}$ = LOW and DVB_ASI = HIGH): Not defined</p> <p>Data-Through mode ($\overline{\text{SMPTE_BYPASS}}$ = LOW and DVB_ASI = LOW): Data output</p> <hr/> <p>10-bit mode 20bit/10bit = LOW</p> <p>SMPTE mode ($\overline{\text{SMPTE_BYPASS}}$ = HIGH and DVB_ASI = LOW): Multiplexed Luma/Chroma data output for SD and HD data rates</p> <p>DVB-ASI mode ($\overline{\text{SMPTE_BYPASS}}$ = LOW and DVB_ASI = HIGH): 8b/10b decoded DVB-ASI data</p> <p>Data-Through mode ($\overline{\text{SMPTE_BYPASS}}$ = LOW and DVB_ASI = LOW): Data output</p>
B1	A_VDD		Input Power	POWER pin for analog circuitry. Connect to 3.3V DC analog.
B2, C3, C4	PLL_VDD		Input Power	POWER pins for the Reclocker PLL. Connect to 1.2V DC analog.
B3, F2	RSV			These pins must be left unconnected.
B4	VCO_GND		Input Power	GND pin for the VCO. Connect to analog GND.
B7, D9, G9, J7	IO_GND		Input Power	GND connection for digital I/O. Connect to digital GND.
C1, D1	SDI, $\overline{\text{SDI}}$		Analog Input	Serial Digital Differential Input.
C2, D2, D3, E3, F3, G2	A_GND		Input Power	GND pins for sensitive analog circuitry. Connect to analog GND.
C7	$\overline{\text{RESET_TRST}}$		Input	<p>CONTROL SIGNAL INPUT</p> <p>Please refer to the Input Logic parameters in the DC Electrical Characteristics table for logic level threshold and compatibility.</p> <p>Used to reset the internal operating conditions to default settings and to reset the JTAG sequence.</p> <p>Normal mode (JTAG/$\overline{\text{HOST}}$ = LOW): When LOW, all functional blocks are set to default conditions and all digital output signals become high impedance. When HIGH, normal operation of the device resumes.</p> <p>JTAG test mode (JTAG/$\overline{\text{HOST}}$ = HIGH): When LOW, all functional blocks are set to default and the JTAG test sequence is reset. When HIGH, normal operation of the JTAG test sequence resumes after $\overline{\text{RESET_TRST}}$ is de-asserted.</p>
D4, E4, F4	PLL_GND		Input Power	GND pins for the Reclocker PLL. Connect to analog GND.

Table 1-1: Pin Descriptions (Continued)

Pin Number	Name	Timing	Type	Description
D5, E5, F5, G4, G5	CORE_GND		Input Power	GND connection for device core. Connect to digital GND.
D6, E6, F6, G6	CORE_VDD		Input Power	POWER connection for device core. Connect to 1.2V DC digital.
D7	SW_EN		Input	CONTROL SIGNAL INPUT Please refer to the Input Logic parameters in the DC Electrical Characteristics table for logic level threshold and compatibility. Used to enable switch-line locking, as described in Section 4.9.1 .
D8	JTAG/ $\overline{\text{HOST}}$		Input	CONTROL SIGNAL INPUT Please refer to the Input Logic parameters in the DC Electrical Characteristics table for logic level threshold and compatibility. Used to select JTAG test mode or host interface mode. When JTAG/ $\overline{\text{HOST}}$ is HIGH, the host interface port is configured for JTAG test. When JTAG/ $\overline{\text{HOST}}$ is LOW, normal operation of the host interface port resumes.
E1	EQ_VDD		Input Power	POWER pin for SDI buffer. Connect to 3.3V DC analog.
E2	EQ_GND		Input Power	GND pin for SDI buffer. Connect to analog GND.
E7	SDOUT_TDO		Output	COMMUNICATION SIGNAL OUTPUT Please refer to the Output Logic parameters in the DC Electrical Characteristics table for logic level threshold and compatibility. GSPI serial data output/test data out. In JTAG mode (JTAG/ $\overline{\text{HOST}}$ = HIGH), this pin is used to shift test results from the device. In host interface mode, this pin is used to read status and configuration data from the device. Note: GSPI is slightly different than the SPI. For more details on GSPI, please refer to 4.19 GSPI - HOST Interface .
E8	SDIN_TDI		Input	COMMUNICATION SIGNAL INPUT Please refer to the Input Logic parameters in the DC Electrical Characteristics table for logic level threshold and compatibility. GSPI serial data in/test data in. In JTAG mode (JTAG/ $\overline{\text{HOST}}$ = HIGH), this pin is used to shift test data into the device. In host interface mode, this pin is used to write address and configuration data words into the device.
F1, G1	AGCP, AGCN			Automatic Gain Control for the equalizer. Attach the AGC capacitor between these pins.

Table 1-1: Pin Descriptions (Continued)

Pin Number	Name	Timing	Type	Description				
F7	$\overline{CS_TMS}$		Input	<p>COMMUNICATION SIGNAL INPUT</p> <p>Please refer to the Input Logic parameters in the DC Electrical Characteristics table for logic level threshold and compatibility.</p> <p>Chip select / test mode start.</p> <p>In JTAG mode ($JTAG/\overline{HOST} = \text{HIGH}$), this pin is Test Mode Start, used to control the operation of the JTAG test.</p> <p>In host interface mode ($JTAG/\overline{HOST} = \text{LOW}$), this pin operates as the host interface chip select and is active LOW.</p>				
F8	SCLK_TCK		Input	<p>COMMUNICATION SIGNAL INPUT</p> <p>Please refer to the Input Logic parameters in the DC Electrical Characteristics table for logic level threshold and compatibility.</p> <p>Serial data clock signal.</p> <p>In JTAG mode ($JTAG/\overline{HOST} = \text{HIGH}$), this pin is the JTAG clock.</p> <p>In host interface mode ($JTAG/\overline{HOST} = \text{LOW}$), this pin is the host interface serial bit clock.</p> <p>All JTAG/host interface addresses and data are shifted into/out of the device synchronously with this clock.</p>				
F9, F10, H9, H10, J8, J9, J10, K8, K9, K10	DOUT8, 9, 6, 7, 1, 4, 5, 0, 2, 3		Output	<p>PARALLEL DATA BUS</p> <p>Please refer to the Output Logic parameters in the DC Electrical Characteristics table for logic level threshold and compatibility.</p> <hr/> <table border="0"> <tr> <td style="vertical-align: top;"> <p>20-bit mode $20\text{bit}/\overline{10\text{bit}} = \text{HIGH}$</p> </td> <td style="vertical-align: top;"> <p>SMPTE mode ($\overline{SMPTE_BYPASS} = \text{HIGH}$ and $DVB_ASI = \text{LOW}$): Chroma data output for SD and HD data rates</p> <p>DVB-ASI mode ($\overline{SMPTE_BYPASS} = \text{LOW}$ and $DVB_ASI = \text{HIGH}$): Not defined</p> <p>Data-Through mode ($\overline{SMPTE_BYPASS} = \text{LOW}$ and $DVB_ASI = \text{LOW}$): Data output</p> </td> </tr> </table> <hr/> <table border="0"> <tr> <td style="vertical-align: top;"> <p>10-bit mode $20\text{bit}/\overline{10\text{bit}} = \text{LOW}$</p> </td> <td style="vertical-align: top;"> <p>Forced LOW</p> </td> </tr> </table>	<p>20-bit mode $20\text{bit}/\overline{10\text{bit}} = \text{HIGH}$</p>	<p>SMPTE mode ($\overline{SMPTE_BYPASS} = \text{HIGH}$ and $DVB_ASI = \text{LOW}$): Chroma data output for SD and HD data rates</p> <p>DVB-ASI mode ($\overline{SMPTE_BYPASS} = \text{LOW}$ and $DVB_ASI = \text{HIGH}$): Not defined</p> <p>Data-Through mode ($\overline{SMPTE_BYPASS} = \text{LOW}$ and $DVB_ASI = \text{LOW}$): Data output</p>	<p>10-bit mode $20\text{bit}/\overline{10\text{bit}} = \text{LOW}$</p>	<p>Forced LOW</p>
<p>20-bit mode $20\text{bit}/\overline{10\text{bit}} = \text{HIGH}$</p>	<p>SMPTE mode ($\overline{SMPTE_BYPASS} = \text{HIGH}$ and $DVB_ASI = \text{LOW}$): Chroma data output for SD and HD data rates</p> <p>DVB-ASI mode ($\overline{SMPTE_BYPASS} = \text{LOW}$ and $DVB_ASI = \text{HIGH}$): Not defined</p> <p>Data-Through mode ($\overline{SMPTE_BYPASS} = \text{LOW}$ and $DVB_ASI = \text{LOW}$): Data output</p>							
<p>10-bit mode $20\text{bit}/\overline{10\text{bit}} = \text{LOW}$</p>	<p>Forced LOW</p>							
G3	$\overline{RC_BYP}$		Input	<p>CONTROL SIGNAL INPUT</p> <p>Please refer to the Input Logic parameters in the DC Electrical Characteristics table for logic level threshold and compatibility.</p> <p>When this pin is LOW, the serial digital output is the buffered version of the input serial data. When this pin is HIGH, the serial digital output is the reclocked version of the input serial data.</p>				

Table 1-1: Pin Descriptions (Continued)

Pin Number	Name	Timing	Type	Description
G7	$\overline{\text{SMPTE_BYPASS}}$		Input/Output	<p>CONTROL SIGNAL INPUT/OUTPUT</p> <p>Please refer to the Input/Output Logic parameters in the DC Electrical Characteristics table for logic level threshold and compatibility.</p> <p>Indicates the presence of valid SMPTE data.</p> <p>When the $\text{AUTO}/\overline{\text{MAN}}$ bit in the host interface register is HIGH (Default), this pin is an OUTPUT. $\overline{\text{SMPTE_BYPASS}}$ is HIGH when the device locks to a SMPTE compliant input. $\overline{\text{SMPTE_BYPASS}}$ is LOW under all other conditions.</p> <p>When the $\text{AUTO}/\overline{\text{MAN}}$ bit in the host interface register is LOW, this pin is an INPUT:</p> <p>No SMPTE scrambling takes place, and none of the I/O processing features of the device are available when $\overline{\text{SMPTE_BYPASS}}$ is set LOW.</p> <p>When $\overline{\text{SMPTE_BYPASS}}$ is set HIGH, the device carries out SMPTE scrambling and I/O processing.</p> <p>When $\overline{\text{SMPTE_BYPASS}}$ and DVB_ASI are both set LOW, the device operates in Data-Through mode.</p>
G8	DVB_ASI		Input/Output	<p>CONTROL SIGNAL INPUT</p> <p>Please refer to the Input/Output Logic parameters in the DC Electrical Characteristics table for logic level threshold and compatibility.</p> <p>Used to enable/disable DVB-ASI data extraction in manual mode.</p> <p>When the $\text{AUTO}/\overline{\text{MAN}}$ bit in the host interface is LOW, this pin is an input and when the DVB_ASI pin is set HIGH the device will carry out DVB_ASI data extraction and processing. The $\overline{\text{SMPTE_BYPASS}}$ pin must be set LOW. When $\overline{\text{SMPTE_BYPASS}}$ and DVB_ASI are both set LOW, the device operates in Data-Through mode.</p> <p>When the $\text{AUTO}/\overline{\text{MAN}}$ bit in the host interface is HIGH (default), DVB-ASI is configured as a status output (set LOW), and DVB-ASI input streams are not supported or recognized.</p>
H1	BUFF_VDD		Input Power	POWER pin for the serial digital output 50Ω buffer. Connect to 3.3V DC analog.
H2	BUFF_GND		Input Power	GND pin for the cable driver buffer. Connect to analog GND.
H3	$\text{AUDIO_EN}/\overline{\text{DIS}}$		Input	<p>CONTROL SIGNAL INPUT</p> <p>Please refer to the Input Logic parameters in the DC Electrical Characteristics table for logic level threshold and compatibility.</p> <p>Enables or disables audio extraction.</p>
H4	WCLK		Output	<p>48kHz word clock for Audio.</p> <p>Please refer to the Output Logic parameters in the DC Electrical Characteristics table for logic level threshold and compatibility.</p>
H5	TIM_861		Input	<p>CONTROL SIGNAL INPUT</p> <p>Please refer to the Input Logic parameters in the DC Electrical Characteristics table for logic level threshold and compatibility.</p> <p>Used to select CEA-861 timing mode.</p> <p>When TIM_861 is HIGH, the device outputs CEA 861 timing signals ($\text{HSYNC}/\overline{\text{VSYNC}}/\text{DE}$) instead of H:V:F digital timing signals.</p>
H6	XTAL_OUT		Digital Output	Buffered 27MHz crystal output. Can be used to cascade the crystal signal.

Table 1-1: Pin Descriptions (Continued)

Pin Number	Name	Timing	Type	Description
H7	20bit/ $\overline{10bit}$		Input	CONTROL SIGNAL INPUT Please refer to the Input Logic parameters in the DC Electrical Characteristics table for logic level threshold and compatibility. Used to select the output bus width. HIGH = 20-bit, LOW = 10-bit.
H8	IOPROC_EN/ \overline{DIS}		Input	CONTROL SIGNAL INPUT Please refer to the Input Logic parameters in the DC Electrical Characteristics table for logic level threshold and compatibility. Used to enable or disable audio and video processing features. When IOPROC_EN is HIGH, the audio and video processing features of the device are enabled. When IOPROC_EN is LOW, the processing features of the device are disabled, and the device is in a low-latency operating mode.
J1, K1	SDO, \overline{SDO}		Output	Serial Data Output Signal. 50Ω CML buffer for interfacing to an external cable driver. Serial digital output signal operating at 1.485Gb/s, 1.485/1.001Gb/s and 270Mb/s.
J2	SDO_EN/ \overline{DIS}		Input	CONTROL SIGNAL INPUT Please refer to the Input Logic parameters in the DC Electrical Characteristics table for logic level threshold and compatibility. Used to enable/disable the serial digital output stage. When SDO_EN/ \overline{DIS} is LOW, the serial digital output signals, SDO and \overline{SDO} , are both pulled HIGH. When SDO_EN/ \overline{DIS} is HIGH, the serial digital output signals, SDO and \overline{SDO} , are enabled.
J3	AOUT_1/2		Output	Serial Audio Output; Channels 1 and 2. Please refer to the Output Logic parameters in the DC Electrical Characteristics table for logic level threshold and compatibility.
J4	ACLK		Output	64fs sample clock for audio. Please refer to the Output Logic parameters in the DC Electrical Characteristics table for logic level threshold and compatibility.
J5	AOUT_5/6		Output	Serial Audio Output; Channels 5 and 6. Please refer to the Output Logic parameters in the DC Electrical Characteristics table for logic level threshold and compatibility.
J6, K6	XTAL2, XTAL1		Analog Input	Input connection for 27MHz crystal.
K2	STANDBY		Input	CONTROL SIGNAL INPUT Please refer to the Input Logic parameters in the DC Electrical Characteristics table for logic level threshold and compatibility. When this pin is set HIGH, the device is placed in a power-saving mode. No data processing occurs, and the digital I/Os are powered down. In this mode, the serial digital output signals, SDO and \overline{SDO} , are both pulled HIGH.
K3	AOUT_3/4		Output	Serial Audio Output; Channels 3 and 4. Please refer to the Output Logic parameters in the DC Electrical Characteristics table for logic level threshold and compatibility.

Table 1-1: Pin Descriptions (Continued)

Pin Number	Name	Timing	Type	Description
K4	AMCLK		Output	Oversampled master clock for audio (128fs, 256fs, 512fs selectable). Please refer to the Output Logic parameters in the DC Electrical Characteristics table for logic level threshold and compatibility.
K5	AOUT_7/8		Output	Serial Audio Output; Channels 7 and 8. Please refer to the Output Logic parameters in the DC Electrical Characteristics table for logic level threshold and compatibility.

2. Electrical Characteristics

2.1 Absolute Maximum Ratings

Table 2-1: Absolute Maximum Ratings

Parameter	Value/Units
Supply Voltage, Digital Core (CORE_VDD)	-0.3V to +1.5V
Supply Voltage, Digital I/O (IO_VDD)	-0.3V to +4.0V
Supply Voltage, Analog 1.2V (PD_VDD, VCO_VDD)	-0.3V to +1.5V
Supply Voltage, Analog 3.3V (EQ_VDD, BUFF_VDD, A_VDD)	-0.3V to +4.0V
Input Voltage Range (digital inputs)	-2.0V to +5.25V
Ambient Operating Temperature (T_A)	$-40^{\circ}\text{C} \leq T_A \leq 95^{\circ}\text{C}$
Storage Temperature (T_{STG})	$-40^{\circ}\text{C} \leq T_{STG} \leq 125^{\circ}\text{C}$
Peak Reflow Temperature (JEDEC J-STD-020C)	260°C
ESD Sensitivity, HBM (JESD22-A114)	2kV

NOTES:

Absolute Maximum Ratings are those values beyond which damage may occur. Functional operation under these conditions or at any other condition beyond those indicated in the AC/DC Electrical Characteristics sections is not implied.

2.2 Recommended Operating Conditions

Table 2-2: Recommended Operating Conditions

Parameter	Symbol	Conditions	Min	Typ	Max	Units	Notes
Operating Temperature Range, Ambient	T_A	–	-20	–	85	°C	–
Supply Voltage, Digital Core	CORE_VDD	–	1.14	1.2	1.26	V	–
Supply Voltage, Digital I/O	IO_VDD	1.8V mode	1.71	1.8	1.89	V	–
		3.3V mode	3.13	3.3	3.47	V	–
Supply Voltage, PLL	PLL_VDD	–	1.14	1.2	1.26	V	–
Supply Voltage, VCO	VCO_VDD	–	–	0.7	–	V	1
Supply Voltage, Analog	A_VDD	–	3.13	3.3	3.47	V	2
Supply Voltage, Serial Digital Input	EQ_VDD	–	3.13	3.3	3.47	V	2
Supply Voltage, CD Buffer	BUFF_VDD	–	3.13	3.3	3.47	V	2

NOTES

1. This is 0.7V rather than 1.2V because there is a voltage drop across an external 105Ω resistor. See [Typical Application Circuit on page 125](#).
2. The 3.3V supplies must track the 3.3V supply of an external CD.

2.3 DC Electrical Characteristics

Table 2-3: DC Electrical Characteristics

Guaranteed over recommended operating conditions unless otherwise noted.

Parameter	Symbol	Conditions	Min	Typ	Max	Units	Notes
System							
+1.2V Supply Current	I_{1V2}	10/20bit HD	–	170	220	mA	–
		10/20bit SD	–	140	185	mA	–
		DVB_ASI	–	130	170	mA	–
+1.8V Supply Current	I_{1V8}	10/20bit HD	–	15	21	mA	–
		10/20bit SD	–	4	7	mA	–
		DVB_ASI	–	4	6	mA	–
+3.3V Supply Current	I_{3V3}	10/20bit HD	–	110	135	mA	–
		10/20bit SD	–	90	100	mA	–
		DVB_ASI	–	90	95	mA	–
Total Device Power (IO_VDD = 1.8V)	P_{1D8}	10/20bit HD	–	480	590	mW	–
		10/20bit SD	–	420	520	mW	–
		DVB_ASI	–	410	500	mW	–
		Reset	–	390	–	mW	–
		Standby	–	23	45	mW	–
Total Device Power (IO_VDD = 3.3V)	P_{3D3}	10/20bit HD	–	570	730	mW	–
		10/20bit SD	–	460	560	mW	–
		DVB_ASI	–	440	540	mW	–
		Reset	–	410	–	mW	–
		Standby	–	23	45	mW	–
Digital I/O							
Input Logic LOW	V_{IL}	3.3V or 1.8V operation	IO_VSS -0.3	–	0.3 x IO_VDD	V	–
Input Logic HIGH	V_{IH}	3.3V or 1.8V operation	0.7 x IO_VDD	–	IO_VDD +0.3	V	–
Output Logic LOW	V_{OL}	IOL = 5mA, 1.8V operation	–	–	0.2	V	–
		IOL = 8mA, 3.3V operation	–	–	0.4	V	–
Output Logic HIGH	V_{OH}	IOH = 5mA, 1.8V operation	1.4	–	–	V	–
		IOH = 8mA, 3.3V operation	2.4	–	–	V	–
Serial Input							
Serial Input Common Mode Voltage	–	75Ω load	–	2.2	–	V	–
Serial Output							
Serial Output Common Mode Voltage	–	50Ω load	BUFF_VDD -(0.6/2)	BUFF_VDD -(0.45/2)	BUFF_VDD -(0.35/2)	V	–

Table 2-3: DC Electrical Characteristics (Continued)

Guaranteed over recommended operating conditions unless otherwise noted.

Parameter	Symbol	Conditions	Min	Typ	Max	Units	Notes
-----------	--------	------------	-----	-----	-----	-------	-------

Notes:

The output drive strength of the digital outputs can be programmed through the host interface. please see [Table 4-28: Video Core Configuration and Status Registers](#), register 06Dh for details.

2.4 AC Electrical Characteristics

Table 2-4: AC Electrical Characteristics

Guaranteed over recommended operating conditions unless otherwise noted.

Parameter	Symbol	Conditions	Min	Typ	Max	Units	Notes	
System								
Device Latency: AUDIO_EN = 1, SMPTE mode, IOPROC_EN = 1	-	HD	79	-	83	PCLK	-	
		SD	50	-	59	PCLK	-	
Device Latency: AUDIO_EN = 0, SMPTE mode, IOPROC_EN = 1	-	HD	44	-	48	PCLK	-	
		SD	44	-	48	PCLK	-	
Device Latency: AUDIO_EN = 0, SMPTE mode, IOPROC_EN = 0	-	HD	33	-	36	PCLK	-	
		SD	32	-	35	PCLK	-	
Device Latency: AUDIO_EN = 0, SMPTE bypass, IOPROC_EN = 0	-	HD	6	-	9	PCLK	-	
		SD	5	-	9	PCLK	-	
Device Latency: DVB-ASI	-	SD	12	-	16	PCLK	-	
Reset Pulse Width	t_{reset}	-	1	-	-	ms	-	
Parallel Output								
Parallel Clock Frequency	f_{PCLK}	-	13.5	-	148.5	MHz	-	
Parallel Clock Duty Cycle	DC_{PCLK}	-	40	-	60	%	-	
Output Data Hold Time (1.8V)	t_{oh}	HD 10-bit 6pF Load	DBUS	1.0	-	-	ns	1
			STAT	1.0	-	-	ns	1
		HD 20-bit 6pF Load	DBUS	1.0	-	-	ns	1
			STAT	1.0	-	-	ns	1
		SD 10-bit 6pF Load	DBUS	19.4	-	-	ns	1
			STAT	19.4	-	-	ns	1
		SD 20-bit 6pF Load	DBUS	38.0	-	-	ns	1
			STAT	38.0	-	-	ns	1

Table 2-4: AC Electrical Characteristics (Continued)

Guaranteed over recommended operating conditions unless otherwise noted.

Parameter	Symbol	Conditions	Min	Typ	Max	Units	Notes			
Output Data Hold Time (3.3V)	t_{oh}	HD 10-bit 6pF Cload	DBUS	1.0	–	–	ns	2		
			STAT	1.0	–	–	ns	2		
		HD 20-bit 6pF Cload	DBUS	1.0	–	–	ns	2		
			STAT	1.0	–	–	ns	2		
		SD 10-bit 6pF Cload	DBUS	19.4	–	–	ns	2		
			STAT	19.4	–	–	ns	2		
		SD 20-bit 6pF Cload	DBUS	38.0	–	–	ns	2		
			STAT	38.0	–	–	ns	2		
		Output Data Delay Time (1.8V)	t_{od}	HD 10-bit 15pF Cload	DBUS	–	–	3.7	ns	3
					STAT	–	–	4.4	ns	3
				HD 20-bit 15pF Cload	DBUS	–	–	3.7	ns	3
					STAT	–	–	4.4	ns	3
SD 10-bit 15pF Cload	DBUS			–	–	22.2	ns	3		
	STAT			–	–	22.2	ns	3		
SD 20-bit 15pF Cload	DBUS			–	–	41.0	ns	3		
	STAT			–	–	41.0	ns	3		
Output Data Delay Time (3.3V)	t_{od}			HD 10-bit 15pF Cload	DBUS	–	–	3.7	ns	4
					STAT	–	–	4.1	ns	4
				HD 20-bit 15pF Cload	DBUS	–	–	3.7	ns	4
					STAT	–	–	4.1	ns	4
		SD 10-bit 15pF Cload	DBUS	–	–	22.2	ns	4		
			STAT	–	–	22.2	ns	4		
		SD 20-bit 15pF Cload	DBUS	–	–	41.0	ns	4		
			STAT	–	–	41.0	ns	4		
		Output Data Rise/Fall Time (1.8V)	t_r/t_f	All modes 6pF Cload	STAT	–	–	0.4	ns	1
					DBUS	–	–	0.4	ns	1
					AUDIO	–	–	0.6	ns	1
				All modes 15pF Cload	STAT	–	–	1.5	ns	3
DBUS	–				–	1.4	ns	3		
AUDIO	–				–	2.3	ns	3		

Table 2-4: AC Electrical Characteristics (Continued)

Guaranteed over recommended operating conditions unless otherwise noted.

Parameter	Symbol	Conditions	Min	Typ	Max	Units	Notes	
Output Data Rise/Fall Time (3.3V)	t_r/t_f	All modes 6pF Load	STAT	–	–	0.5	ns	2
			DBUS	–	–	0.4	ns	2
			AUDIO	–	–	0.6	ns	2
		All modes 15pF Load	STAT	–	–	1.6	ns	4
			DBUS	–	–	1.4	ns	4
			AUDIO	–	–	2.2	ns	4
Serial Digital Input								
Serial Input Data Rate	DR_{SDI}	–	0.27	–	1.485	Gb/s	–	
Serial Input Voltage Swing	ΔV_{SDI}	$T_A = 25^\circ\text{C}$, differential, 270Mb/s & 1.485Gb/s	720	800	950	mV _{p-p}	6	
Achievable Cable Length	–	Belden 1694A cable, HD	210	230	–	m	–	
		Belden 1694A cable, SD	400	440	–	m	–	
Input Return Loss	–	single ended	15	21	–	dB	7	
Input Resistance	–	single ended	–	1.52	–	k Ω	–	
Input Capacitance	–	single ended	–	1	–	pF	–	
Serial Digital Output								
Serial Output Data Rate	DR_{SDO}	–	0.27	–	1.485	Gb/s	–	
Serial Output Swing	ΔV_{SDO}	Differential with 100 Ω load	320	–	600	mV _{p-p}	–	
Serial Output Rise Time 20% ~ 80%	tr_{SDO}	–	–	–	180	ps	–	
Serial Output Fall Time 20% ~ 80%	tf_{SDO}	–	–	–	180	ps	–	
Serial Output Jitter with loop-through mode	t_{OJ}	HD, PRB523, Belden 1694A cable, 210m	–	–	100	ps	–	
		SD, PRB523, Belden 1694A cable, 440m	–	–	470	ps	–	
Serial Output Duty Cycle Distortion	DCD_{SDD}	HD	–	10	–	ps	–	
		SD	–	20	–	ps	–	
Synchronous lock time	–	–	–	–	25	μs	–	
Asynchronous lock time	–	–	0.1	–	20	ms	–	
Lock time from power-up	–	After 20 minutes at -20 $^\circ\text{C}$	–	–	5	s	–	

Table 2-4: AC Electrical Characteristics (Continued)

Guaranteed over recommended operating conditions unless otherwise noted.

Parameter	Symbol	Conditions	Min	Typ	Max	Units	Notes
GSPI							
GSPI Input Clock Frequency	f_{SCLK}	50% levels 3.3V or 1.8V operation	–	–	60	MHz	5
GSPI Input Clock Duty Cycle	DC_{SCLK}		40	50	60	%	5
GSPI Input Data Setup Time	–		1.5	–	–	ns	5
GSPI Input Data Hold Time	–		1.5	–	–	ns	5
GSPI Output Data Hold Time	–	–	1.5	–	–	ns	5
\overline{CS} low before SCLK rising edge	–	50% levels 3.3V or 1.8V operation	1.5	–	–	ns	5
Time between end of command word (or data in Auto-Increment mode) and the first SCLK of the following data word - write cycle	–	50% levels 3.3V or 1.8V operation	37.1	–	–	ns	5
Time between end of command word (or data in Auto-Increment mode) and the first SCLK of the following data word - read cycle	–	50% levels 3.3V or 1.8V operation	148.4	–	–	ns	5
\overline{CS} high after SCLK falling edge	–	50% levels 3.3V or 1.8V operation	37.1	–	–	ns	5

Notes:

1. 1.89V and 0°C.
2. 3.47V and 0°C.
3. 1.71V and 85°C
4. 3.13V and 85°C
5. Timing parameters defined in [Section 4.19.3](#)
6. 0m cable length
7. Tested on a GS1671 board from 5MHz to 1.485GHz.

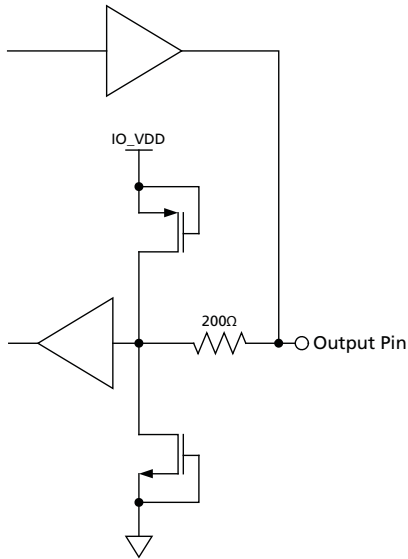

Figure 3-3: Bidirectional Digital Input/Output Pin with programmable drive strength. These pins are configured to output unless in Reset Mode; in which case they are high-impedance. The drive strength can be set by writing to address 06Dh in the host interface register. (DOUT0, DOUT1, DOUT2, DOUT3, DOUT4, DOUT5, DOUT6, DOUT7, DOUT8, DOUT9, SDOUT_TDO, STAT0, STAT1, STAT2, STAT3, STAT4, STAT5, XTAL_OUT, DOUT10, DOUT11, DOUT12, DOUT13, DOUT14, DOUT15, DOUT16, DOUT17, DOUT18, DOUT19, PCLK)

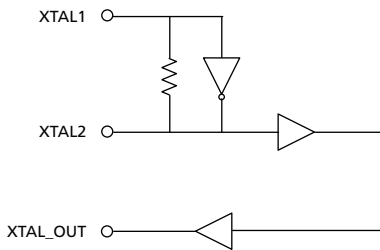

Figure 3-4: XTAL1/XTAL2/XTAL-OUT

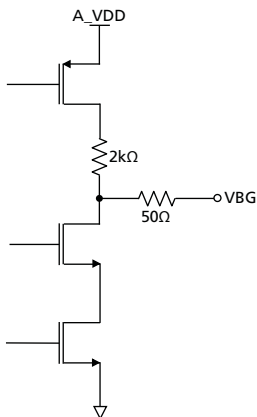

Figure 3-5: VBG

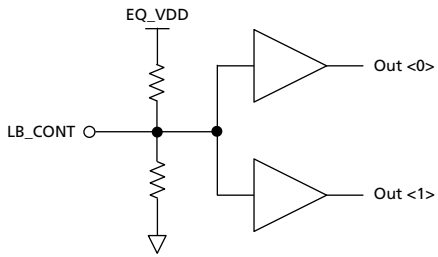

Figure 3-6: LB_CONT

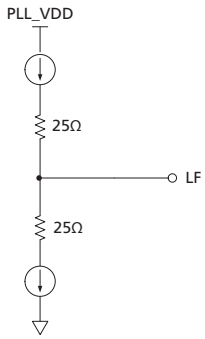

Figure 3-7: Loop Filter

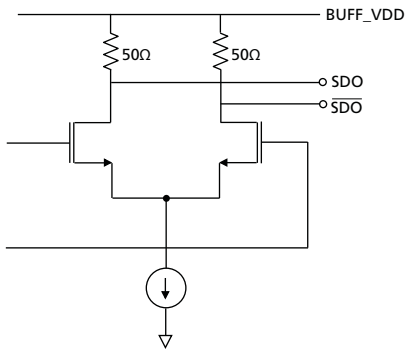

Figure 3-8: SDO/ $\overline{\text{SDO}}$

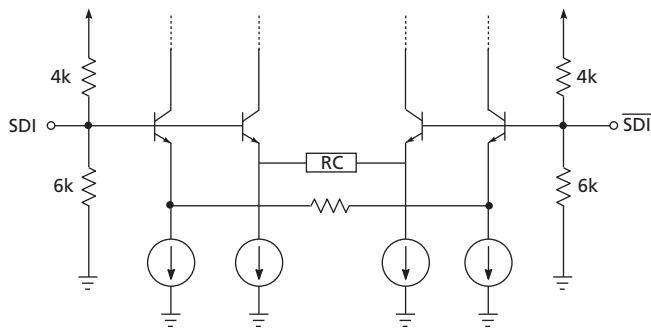

Figure 3-9: Equalizer Input Equivalent Circuit

4. Detailed Description

Refer to the document entitled **GS1670/GS1671 Errata** for this device (document number 53878).

4.1 Functional Overview

The GS1671 is a multi-rate SDI integrated Receiver which includes complete SMPTE processing, as per SMPTE 292M and SMPTE 259M-C. The SMPTE processing features can be bypassed to support signals with other coding schemes.

The GS1671 integrates Gennum's adaptive cable equalizer technology, achieving unprecedented cable lengths and jitter tolerance. It features DC restoration to compensate for the DC content of SMPTE pathological signals.

The device features an Integrated Reclocker with an internal VCO and a wide Input Jitter Tolerance (IJT) of 0.7UI.

A serial digital loop through output is provided, which can be configured to output either reclocked or non-reclocked serial digital data. The Serial Digital Output can be connected to an external Cable Driver.

The device operates in one of four basic modes: SMPTE mode, DVB-ASI mode, Data-Through mode or Standby mode.

In SMPTE mode, the GS1671 performs SMPTE de-scrambling and NRZI to NRZ decoding and word alignment. Line-based CRC errors, line number errors, TRS errors and ancillary data check sum errors can all be detected. The GS1671 also provides ancillary data extraction. The entire ancillary data packet is extracted, and written to host-accessible registers. Other processing functions include H:V:F timing extraction, Luma and Chroma ancillary data indication, video standard detection, and SMPTE 352M packet detection and decoding. All of the processing features are optional, and may be enabled or disabled via the Host Interface.

In DVB-ASI mode, 8b/10b decoding is applied to the received data stream.

In Data-Through mode, all forms of SMPTE and DVB-ASI decoding are disabled, and the device can be used as a simple serial to parallel converter.

The device can also be placed in a lower power Standby mode. In this mode, no signal processing is carried out and the parallel output is held static. Placing the Receiver in Standby mode will automatically place the integrated equalizer in power down mode as well.

Parallel data outputs are provided in 20-bit or 10-bit multiplexed format for HD and SD video rates. In all cases, this 20-bit parallel bus can be multiplexed onto 10 bits for a low pin count interface with downstream devices. The associated Parallel Clock input signal operates at 148.5 or 148.5/1.001MHz (for all HD 10-bit multiplexed modes), 74.25 or 74.25/1.001MHz (for HD 20-bit mode), 27MHz (for SD 10-bit mode) and 13.5MHz (for SD 20-bit mode).

Up to eight channels, in two groups, of serial digital audio may be extracted from the video data stream, in accordance with SMPTE 272M and SMPTE 299M. The output signal formats supported by the device include AES/EBU and three other industry standard

serial digital formats. 16, 20 and 24-bit audio formats are supported at 48kHz synchronous for SD modes and 48kHz synchronous or asynchronous in HD mode. Additional audio processing features include group selection, channel swapping, ECC error detection and correction (HD mode only), and audio channel status extraction. Audio clock and control signals provided by the device include Word Clock (fs), Serial Clock (64fs), and Audio Master Clock at user-selectable rates of 128fs, 256fs or 512fs.

4.2 Serial Digital Input

The GS1671 can accept serial digital inputs compliant with SMPTE 292 and SMPTE 259M-C.

4.2.1 Integrated Adaptive Cable Equalizer

The GS1671 integrates Gennum's adaptive cable equalizer technology.

The integrated adaptive equalizer can equalize HD and SD serial digital signals, and will typically equalize 230m of Belden 1694A cable at 1.485Gb/s and 440m at 270Mb/s. The integrated adaptive equalizer is powered from a single +3.3V power supply and consumes approximately 195mW of power.

The equalizer can be bypassed by programming register 073h through the GSPI interface.

4.2.1.1 Serial Digital Inputs

The Serial Data Signal may be connected to the input pins (SDI/ $\overline{\text{SDI}}$) in either a differential or single ended configuration. AC coupling of the inputs is recommended, as the SDI and $\overline{\text{SDI}}$ inputs are internally biased at approximately 1.8V.

4.2.1.2 Cable Equalization

The input signal passes through a variable gain equalizing stage whose frequency response closely matches the inverse of the cable loss characteristic. In addition, the variation of the frequency response with control voltage imitates the variation of the inverse cable loss characteristic with cable length.

The edge energy of the equalized signal is monitored by a detector circuit which produces an error signal corresponding to the difference between the desired edge energy and the actual edge energy. This error signal is integrated by both an internal and an external AGC filter capacitor providing a steady control voltage for the gain stage. As the frequency response of the gain stage is automatically varied by the application of negative feedback, the edge energy of the equalized signal is kept at a constant level which is representative of the original edge energy at the transmitter. The equalized signal is also DC restored, effectively restoring the logic threshold of the equalized signal to its correct level independent of shifts due to AC-coupling.

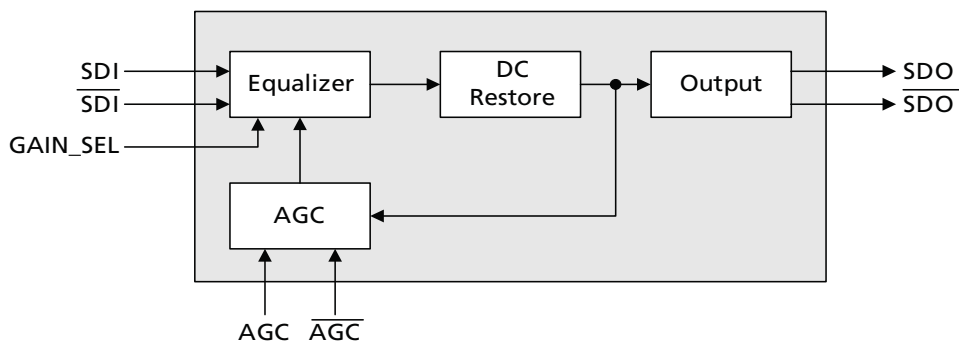

Figure 4-1: GS1671 Integrated EQ Block Diagram

4.3 Serial Digital Loop-Through Output

The GS1671 contains a 100Ω differential serial output buffer which can be configured to output either a retimed or a buffered version of the serial digital input. The SDO and $\overline{\text{SDO}}$ outputs of this buffer can interface directly to a 1.485Gb/s-capable, SMPTE compliant Genum cable driver. See [5.3 Typical Application Circuit on page 125](#).

When the $\overline{\text{RC_BYP}}$ pin is set HIGH, the serial digital output is the re-timed version of the serial input.

When the $\overline{\text{RC_BYP}}$ pin is set LOW, the serial digital output is simply the buffered version of the serial input, bypassing the internal reclocker.

The output can be disabled by setting the SDO_EN/ $\overline{\text{DIS}}$ pin LOW. The output is also disabled when the STANDBY pin is asserted HIGH. When the output is disabled, both SDO and $\overline{\text{SDO}}$ pins are set to VDD and remain static.

The SDO output is muted when the $\overline{\text{RC_BYP}}$ pin is set HIGH and the PLL is unlocked (LOCKED pin is LOW). When muted, the output is held static at logic '0' or logic '1'.

Table 4-1: Serial Digital Output

SDO_EN/ $\overline{\text{DIS}}$	$\overline{\text{RC_BYP}}$	SDO/ $\overline{\text{SDO}}$
0	X	Disabled
1	1	Re-timed
1	0	Buffered (not re-timed)

NOTE: the serial digital output is muted when the GS1671 is unlocked.

4.4 Serial Digital Reclocker

The GS1671 includes both a PLL stage and a sampling stage.

The PLL is comprised of two distinct loops:

- A coarse frequency acquisition loop sets the centre frequency of the integrated Voltage Controlled Oscillator (VCO) using an external 27MHz reference clock
- A fine frequency and phase locked loop aligns the VCO's phase and frequency to the input serial digital stream

The frequency lock loop results in a very fast lock time.

The sampling stage re-times the serial digital input with the locked VCO clock. This generates a clean serial digital stream, which may be output on the SDO/ $\overline{\text{SDO}}$ output pins and converted to parallel data for further processing. Parallel data is not affected by $\overline{\text{RC_BYP}}$. Only the SDO is affected by this pin.

4.4.1 PLL Loop Bandwidth

The fine frequency and phase lock loop in the GS1671 reclocker is non-linear. The PLL loop bandwidth scales with the jitter amplitude of the input data stream; automatically reduces bandwidth in response to higher jitter. This allows the PLL to reject more of the jitter in the input data stream and produce a very clean reclocked output.

The loop bandwidth of the GS1671 PLL is defined with 0.2UI input jitter. The bandwidth is controlled by the LB_CONT pin. Under nominal conditions, with the LB_CONT pin floating and 0.2UI input jitter applied, the loop bandwidth is set to 1/1000 of the frequency of the input data stream. Connecting the LB_CONT pin to 3.3V reduces the bandwidth to half of the nominal setting. Connecting the LB_CONT pin to GND increases the bandwidth to double the nominal setting. [Table 4-2](#) below summarizes this information.

Table 4-2: PLL Loop Bandwidth

Input Data Rate	LB_CONT Pin Connection	Loop Bandwidth (MHz) ¹
SD	3.3V	0.135
	Floating	0.27
	0V	0.54
HD	3.3V	0.75
	Floating	1.5
	0V	3.0

¹Measured with 0.2UI input jitter applied

4.5 External Crystal/Reference Clock

The GS1671 requires an external 27MHz reference clock for correct operation. This reference clock is generated by connecting a crystal to the XTAL1 and XTAL2 pins of the device. See [Application Reference Design on page 124](#). Table 4-3 shows XTAL characteristics.

Alternately, a 27MHz external clock source can be connected to the XTAL1 pin of the device, as shown in [Figure 4-2](#).

The frequency variation of the crystal including aging, supply and temperature variation, should be less than +/-100ppm.

The equivalent series resistance (or motional resistance) should be a maximum of 50Ω.

The external crystal is used in the frequency acquisition process. It has no impact on the output jitter performance of the part when the part is locked to incoming data. Because of this, the only key parameter is the frequency variation of the crystal that is stated above.

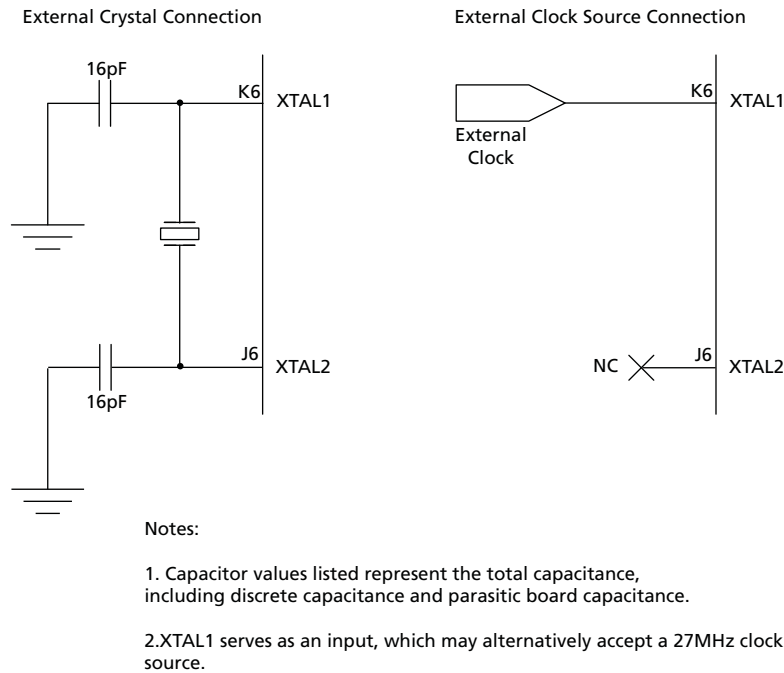

Figure 4-2: 27MHz Clock Sources

Table 4-3: Input Clock Requirements

Parameter	Min	Typ	Max	UOM	Notes
XTAL1 Low Level Input Voltage (V_{il})	–	–	20% of VDD_IO	V	3
XTAL1 High Level Input Voltage (V_{ih})	80% of VDDIO	–	–	V	3
XTAL1 Input Slew Rate	2	–	–	V/ns	3

Table 4-3: Input Clock Requirements (Continued)

Parameter	Min	Typ	Max	UOM	Notes
XTAL1 to XOUT Prop. Delay (High to Low)	1.3	1.5	2.3	ns	3
XTAL1 to XOUT Prop. Delay (Low to High)	1.3	1.6	2.3	ns	3

NOTES:

Valid when the cell is used to buffer an external clock source which is connected to the XTAL1 pin, then nothing should be connected to the XTAL2 pin.

4.6 Lock Detect

The LOCKED output signal is available by default on the STAT3 output pin, but may be programmed to be output through any one of the six programmable multi-functional pins of the device; STAT[5:0].

The LOCKED output signal is set HIGH by the Lock Detect block under the following conditions:

Table 4-4: Lock Detect Conditions

Mode of Operation	Mode Setting	Condition for Locked
Data-Through Mode	$\overline{\text{SMPTE_BYPASS}} = \text{LOW}$ $\text{DVB_ASI} = \text{LOW}$	Reclocker PLL is locked.
SMPTE Mode	$\overline{\text{SMPTE_BYPASS}} = \text{HIGH}$ $\text{DVB_ASI} = \text{LOW}$	Reclocker PLL is locked 2 consecutive TRS words are detected in a 2-line window.
DVB_ASI Mode	$\overline{\text{SMPTE_BYPASS}} = \text{LOW}$ $\text{DVB_ASI} = \text{HIGH}$ $\text{Bit AUTO/MAN} = \text{LOW}$	Reclocker PLL is locked 32 consecutive DVB_ASI words with no errors are detected within a 128-word window.

NOTE 1: The part will lock to ASI in Auto mode, but could falsely unlock for some ASI input patterns.

NOTE 2: In Standby mode, the reclocker PLL unlocks. However, the LOCKED signal retains whatever state it previously held. So, if before Standby assertion, the LOCKED signal is HIGH, then during standby, it remains HIGH regardless of the status of the PLL.

4.6.1 Asynchronous Lock

The lock detection algorithm is a continuous process, beginning at device power-up or after a system reset. It continues until the device is powered down or held in reset.

The device first determines if a valid serial digital input signal has been presented to the device. If no valid serial data stream has been detected, the serial data into the device is considered invalid, and the LOCKED signal is LOW.

Once a valid input signal has been detected, the asynchronous lock algorithm enters a “hunt” phase, in which the device attempts to detect the presence of either TRS words or DVB-ASI sync words.

By default, the device powers up in auto mode (the $\overline{\text{AUTO/MAN}}$ bit in the host interface is set HIGH). In this mode, the device operating frequency toggles between HD and SD rates as it attempts to lock to the incoming data rate. The PCLK output continues to operate, and the frequency may switch between 148.5MHz, 74.25MHz, 27MHz and 13.5MHz.

When the device is operating in manual mode ($\overline{\text{AUTO/MAN}}$ bit in the host interface is LOW), the operating frequency needs to be set through the host interface using the RATE_DET bit. In this mode, the asynchronous lock algorithm does not toggle the operating rate of the device and attempts to lock within a single standard. Lock is achieved within three lines of the selected standard.

4.6.2 Signal Interruption

The device tolerates a signal interruption of up to 10 μ s without unlocking, as long as no TRS words are deleted by this interruption. If a signal interruption of greater than 10 μ s is detected, the lock detection algorithm may lose the current data rate, and LOCKED will de-assert until the data rate is re-acquired by the lock detection block.

4.7 SMPTE Functionality

4.7.1 Descrambling and Word Alignment

The GS1671 performs NRZI to NRZ decoding and data descrambling according to SMPTE 292/SMPTE 259M-C and word aligns the data to TRS sync words.

When operating in manual mode ($\overline{\text{AUTO/MAN}} = \text{LOW}$), the device only carries out SMPTE decoding, descrambling and word alignment when the $\overline{\text{SMPTE_BYPASS}}$ pin is set HIGH and the DVB_ASI pin is set LOW.

When operating in Auto mode ($\overline{\text{AUTO/MAN}} = \text{HIGH}$), the GS1671 carries out descrambling and word alignment to enable the detection of TRS sync words. When two consecutive valid TRS words (SAV and EAV), with the same bit alignment have been detected, the device word-aligns the data to the TRS ID words.

TRS ID word detection is a continuous process. The device remains in SMPTE mode until TRS ID words fail to be detected.

NOTE: Both 8-bit and 10-bit TRS headers are identified by the device.

4.8 Parallel Data Outputs

The parallel data outputs are aligned to the rising edge of the PCLK.

4.8.1 Parallel Data Bus Buffers

The parallel data bus, status signal outputs and control signal input pins are all connected to high-impedance buffers.

The device supports 1.8 or 3.3V (LVTTTL and LVCMOS levels) supplied at the IO_VDD and IO_GND pins.

All output buffers (including the PCLK output), are set to high-impedance in Reset mode ($\overline{\text{RESET_TRST}} = \text{LOW}$).

I/O Timing Specs:

10-bit SDR Mode:

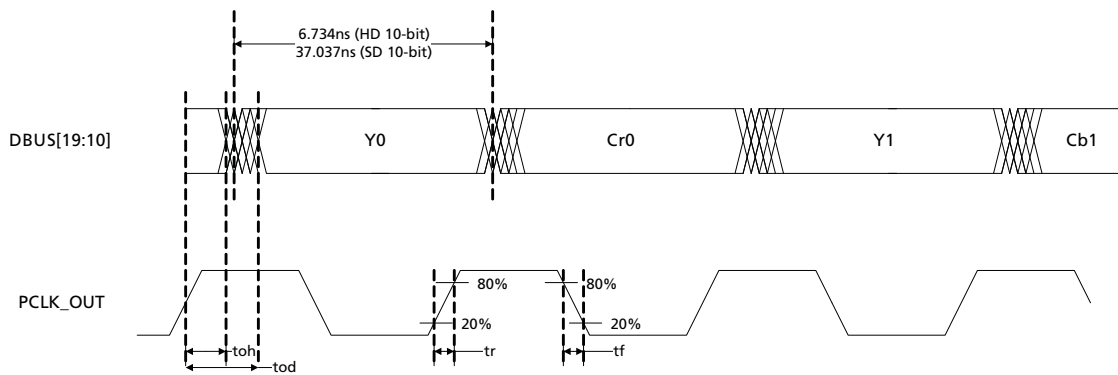

		10bHD Mode						10bSD Mode					
		3.3V			1.8V			3.3V			1.8V		
		toh	tr/tf (min)	Cload	tod	tr/tf (max)	Cload	toh	tr/tf (min)	Cload	tod	tr/tf (max)	Cload
dbus	stat	1.000ns	0.400ns	6 pF	3.700ns	1.400ns	15 pF	1.000ns	0.400ns	6 pF	3.700ns	1.400ns	15 pF
		1.000ns	0.500ns		4.100ns	1.600ns		1.000ns	0.400ns		4.400ns	1.500ns	

Figure 4-3: PCLK to Data and Control Signal Output Timing - SDR Mode 1

I/O Timing Specs:

20-bit SDR Mode:

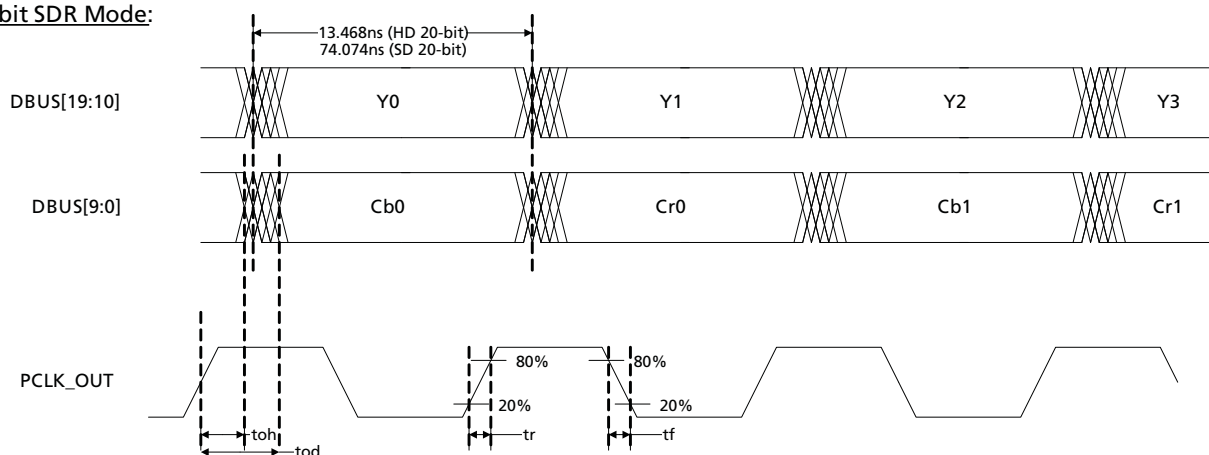

20bHD Mode												
	3.3V						1.8V					
	toh	tr/tf (min)	Cload	tod	tr/tf (max)	Cload	toh	tr/tf (min)	Cload	tod	tr/tf (max)	Cload
dbus	1.000ns	0.400ns	6 pF	3.700ns	1.400ns	15 pF	1.000ns	0.400ns	6 pF	3.700ns	1.400ns	15 pF
stat	1.000ns	0.500ns		4.100ns	1.600ns		1.000ns	0.400ns		4.400ns	1.500ns	

20bSD Mode												
	3.3V						1.8V					
	toh	tr/tf (min)	Cload	tod	tr/tf (max)	Cload	toh	tr/tf (min)	Cload	tod	tr/tf (max)	Cload
dbus	38.000ns	0.400ns	6 pF	41.000ns	1.400ns	15 pF	38.000ns	0.400ns	6 pF	41.000ns	1.400ns	15 pF
stat	38.000ns	0.500ns		41.000ns	1.600ns		38.000ns	0.400ns		41.000ns	1.500ns	

Figure 4-4: PCLK to Data and Control Signal Output Timing - SDR Mode 2

The GS1671 has a 20-bit output parallel bus, which can be configured for different output formats as shown in [Table 4-5](#).

Table 4-5: GS1671 Output Video Data Format Selections

Output Data Format	Pin/Register Bit Settings				DOUT[9:0]	DOUT[19:10]
	20BIT /10BIT	RATE_SEL	SMPTE BYPASS	DVB-ASI		
20-bit demultiplexed HD format	HIGH	LOW	HIGH	LOW	Chroma	Luma
20-bit data output HD format	HIGH	LOW	LOW	LOW	DATA	DATA
20-bit demultiplexed SD format	HIGH	HIGH	HIGH	LOW	Chroma	Luma
20-bit data output SD format	HIGH	HIGH	LOW	LOW	DATA	DATA

Table 4-5: GS1671 Output Video Data Format Selections (Continued)

Output Data Format	Pin/Register Bit Settings				DOUT[9:0]	DOUT[19:10]
	20BIT /10BIT	RATE_SEL	SMPTE_BYPASS	DVB-ASI		
10-bit multiplexed HD format	LOW	LOW	HIGH	LOW	Driven LOW	Luma/Chroma
10-bit data output HD format	LOW	LOW	LOW	LOW	Driven LOW	DATA
10-bit multiplexed SD format	LOW	HIGH	HIGH	LOW	Driven LOW	Luma/Chroma
10-bit data output SD format	LOW	HIGH	LOW	LOW	Driven LOW	DATA
DVB-ASI format	LOW	HIGH	–	HIGH	DOUT19 = WORD_ERR DOUT18 = SYNC_OUT DOUT17 = H_OUT DOUT16 = G_OUT DOUT15 = F_OUT DOUT14 = E_OUT DOUT13 = D_OUT DOUT12 = C_OUT DOUT11 = B_OUT DOUT10 = A_OUT	

NOTE: When in Auto Mode, swap RATE_SEL with RATE_DET.

4.8.2 Parallel Output in SMPTE Mode

When the device is operating in SMPTE mode ($\overline{\text{SMPTE_BYPASS}} = \text{HIGH}$ and $\text{DVB_ASI} = \text{LOW}$), data is output in either Multiplexed or Demultiplexed form depending on the setting of the 20bit/ $\overline{10\text{bit}}$ pin.

When operating in 20-bit mode ($\overline{20\text{bit}/10\text{bit}} = \text{HIGH}$), the output data is demultiplexed Luma and Chroma data for SD and HD data rates.

When operating in 10-bit mode ($\overline{20\text{bit}/10\text{bit}} = \text{LOW}$), the output data is multiplexed Luma and Chroma data for SD and HD data rates. In this mode, the data is presented on the DOUT[19:10] pins, with DOUT[9:0] being forced LOW.

4.8.3 Parallel Output in DVB-ASI Mode

In DVB-ASI mode, the 20bit/ $\overline{10\text{bit}}$ pin must be set LOW to configure the output parallel bus for 10-bit operation.

DVB-ASI mode is enabled when the $\text{AUTO}/\overline{\text{MAN}}$ bit is LOW, $\overline{\text{SMPTE_BYPASS}}$ pin is LOW and the DVB_ASI pin is HIGH.

The extracted 8-bit data is presented on DOUT[17:10] such that $\text{DOUT}[17:10] = \text{HOUT} \sim \text{AOUT}$, where AOUT is the least significant bit of the decoded transport stream data.

In addition, the DOUT19 and DOUT18 pins are configured as DVB-ASI status signals WORDERR and SYNCOUT respectively.

SYNCOUT is HIGH whenever a K28.5 sync character is output from the device.

WORDERR is HIGH whenever the device has detected a running disparity error or illegal code word.

4.8.4 Parallel Output in Data-Through Mode

This mode is enabled when the $\overline{\text{SMPTE_BYPASS}}$ and $\overline{\text{DVB_ASI}}$ pins are LOW.

In this mode, data is passed to the output bus without any decoding, descrambling or word-alignment.

The output data width (10-bit or 20-bit) is controlled by the setting of the $\overline{20\text{bit}/10\text{bit}}$ pin.

4.8.5 Parallel Output Clock (PCLK)

The frequency of the PCLK output signal of the GS1671 is determined by the output data rate and the $\overline{20\text{bit}/10\text{bit}}$ pin setting. Table 4-6 lists the output signal formats according to the data format selected in Manual mode ($\overline{\text{AUTO/MAN}}$ bit in the host interface is set LOW), or detected in Auto mode ($\overline{\text{AUTO/MAN}}$ bit in the host interface is set HIGH).

Table 4-6: GS1671 PCLK Output Rates

Output Data Format	Pin/Control Bit Settings				PCLK Rate
	$\overline{20\text{bit}/10\text{bit}}$	RATE_DET	$\overline{\text{SMPTE_BYPASS}}$	$\overline{\text{DVB-ASI}}$	
20-bit demultiplexed HD format	HIGH	LOW	HIGH	LOW	74.25 or 74.25/1.001MHz
20-bit data output HD format	HIGH	LOW	LOW	LOW	74.25 or 74.25/1.001MHz
20-bit demultiplexed SD format	HIGH	HIGH	HIGH	LOW	13.5MHz
20-bit data output SD format	HIGH	HIGH	LOW	LOW	13.5MHz
10-bit multiplexed HD format	LOW	LOW	HIGH	LOW	148.5 or 148.5/1.001MHz
10-bit data output HD format	LOW	LOW	LOW	LOW	148.5 or 148.5/1.001MHz
10-bit multiplexed SD format	LOW	HIGH	HIGH	LOW	27MHz
10-bit data output SD format	LOW	HIGH	LOW	LOW	27MHz
10-bit ASI output SD format	LOW	HIGH	LOW	HIGH	27MHz

4.9 Timing Signal Generator

The GS1671 has an internal timing signal generator which is used to generate digital FVH timing reference signals, to detect and correct certain error conditions and automatic video standard detection.

The timing signal generator is only operational in SMPTE mode ($\overline{\text{SMPTE_BYPASS}} = \text{HIGH}$).

The timing signal generator consists of a number of counters and comparators operating at video pixel and video line rates. These counters maintain information about the total line length, active line length, total number of lines per field/frame and total active lines per field/frame for the received video standard.

It takes one video frame to obtain full synchronization to the received video standard.

NOTE: Both 8-bit and 10-bit TRS words are identified by the device. Once synchronization has been achieved, the timing signal generator continues to monitor the received TRS timing information to maintain synchronization.

The timing signal generator re-synchronizes all pixel and line based counters on every received TRS ID. Note that for correct operation of the timing signal generator, the SW_EN input pin must be set LOW, unless manual synchronous switching is enabled (Section 4.9.1).

4.9.1 Manual Switch Line Lock Handling

The principle of switch line lock handling is that the switching of synchronous video sources will only disturb the horizontal timing and alignment, whereas the vertical timing remains in synchronization - i.e. switching between video sources of the same format.

To account for the horizontal disturbance caused by a synchronous switch, the word alignment block and timing signal generator automatically re-synchronizes to the new timing immediately if the synchronous switch happens during the designated switch line, as defined in SMPTE recommended practice RP168-2002.

The device samples the SW_EN pin on every PCLK cycle. When a Logic LOW to HIGH transition on this pin is detected anywhere within the active line, the word alignment block and timing signal generator re-synchronize immediately to the next TRS word.

This allows the system to force immediate lock on any line, if the switch point is non-standard.

To ensure proper switch line lock handling, the SW_EN signal should be asserted HIGH anywhere within the active portion of the line on which the switch has taken place, and should be held HIGH for approximately one video line. After this time period, SW_EN should be de-asserted. SW_EN should be held LOW during normal device operation.

NOTE: It is the rising edge of the SW_EN signal, which generates the switch line lock re-synchronization. This edge must be in the active portion of the line containing the video switch point.

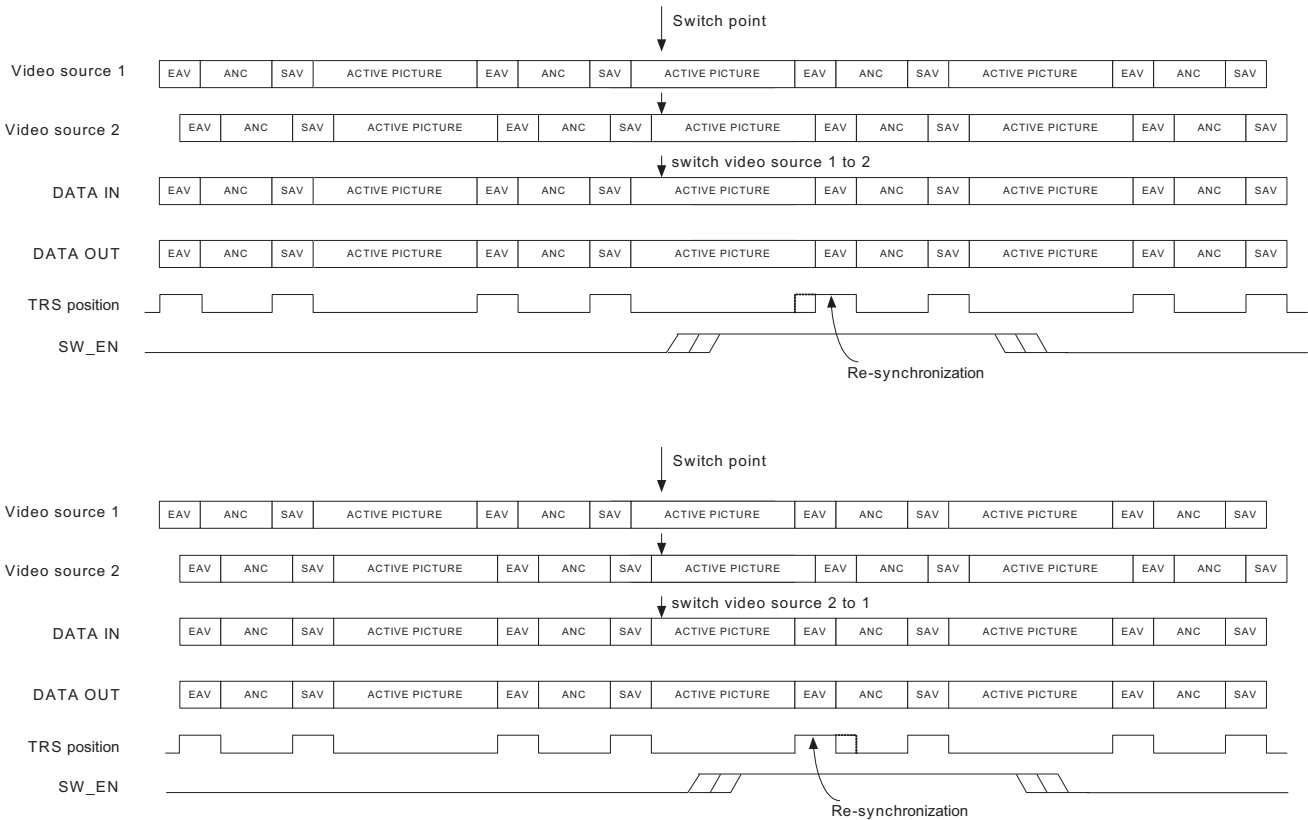

Figure 4-5: Switch Line Locking on a Non-Standard Switch Line

4.9.2 Automatic Switch Line Lock Handling

The synchronous switch point is defined for all major video standards in SMPTE RP168-2002. The device automatically re-synchronizes the word alignment block and timing signal generator at the switch point, based on the detected video standard.

The device, as described in [Section 4.9.1](#) and [Figure 4-5](#) above, implements the re-synchronization process automatically, every field/frame. The switch line is defined as follows:

- For 525 line interlaced systems: resynchronization takes place at then end of lines 10 & 273
- For 525 line progressive systems: resynchronization takes place at then end of line 10
- For 625 line interlaced systems: resynchronization takes place at then end of lines 6 & 319
- For 625 line progressive systems: resynchronization takes place at then end of line 6
- For 750 line progressive systems: resynchronization takes place at then end of line 7
- For 1125 line interlaced systems: resynchronization takes place at then end of lines 7 & 568
- For 1125 line progressive systems: resynchronization takes place at then end of line 7

NOTE: Unless indicated by SMPTE 352M payload identifier packets, the GS1671 does not distinguish between 1125-line progressive segmented-frame (PsF) video and 1125-line interlaced video operating at 25 or 30fps. However, PsF video operating at 24fps is detected by the device.

A full list of all major video standards and switching lines is shown in [Table 4-7](#).

Table 4-7: Switch Line Position for Digital Systems

System	Frame Rate & Structure	Pixel Structure		Signal Standard	Parallel Interface	Serial Interface	Line No.
1125	60/I	1920x1080	4:2:2	274M + RP211		292	7/569
	50/I			274M + RP211			
	30/P			274M + RP211			7
	25/P			274M + RP211			
	24/P			274M + RP211			
	30/PsF			274M + RP211			
	25/PsF			274M + RP211			
	24/PsF			274M + RP211			
750	60/P	1280x720	4:2:2	296M		292	7
	50/P			296M			
	30/P			296M			
	25/P			296M			
	24/P			296M			
625	50/P	720x576	4:2:2	BT.1358	349M	292	6
				BT.1358	347M	344M	
				BT.1358	BT.1358	BT.1362	
			4:2:0	BT.1358	349M	292	
				BT.1358	BT.1358	BT.1362	
				50/I	960x576	4:2:2	
	BT.601	BT.656	259M				
	720x576	4:4:4:4	BT.799		349M	292	
			BT.799		347M	344M	
			BT.799		BT.799	344M	
			BT.799		BT.799	-	
	4:2:2	BT.601	349M	292			
BT.601		125M	259M				

Table 4-7: Switch Line Position for Digital Systems (Continued)

System	Frame Rate & Structure	Pixel Structure		Signal Standard	Parallel Interface	Serial Interface	Line No.
525	59.94/P	720x483	4:2:2	293M	349M	292	10
				293M	347M	344M	
				293M	293M	294M	
		4:2:0	293M	349M	292		
			293M	293M	294M		
	59.94/I	960x483	4:2:2	267M	349M	292	10/273
				267M	267M	259M	
		720x483	4:4:4	267M	349M	292	
				267M	347M	344M	
				267M	RP174	344M	
4:2:2	125M	349M	292				
	125M	125M	259M				
HD-SDTI	P or PsF structure	1920x1080	4:2:2	274M	274M + 348M	292	7
	I structure			274M			7/569
	P structure	1280x720	296M	296M + 348M	7		
SDTI	50/I	720x576	4:2:2	BT.656	BT.656 + 305M	259M	6/319
	59.94/I	720x483		125M			125M + 305M

4.10 Programmable Multi-function Outputs

The GS1671 has 6 multi-function output pins, STAT [5:0], which are programmable via the host interface to output one of the following signals:

Table 4-8: Output Signals Available on Programmable Multi-Function Pins

Status Signal	Selection Code	Default Output Pin
H/HSYNC (according to TIM_861 Pin) Section 4.11	0000	STAT 0
V/VSYSN (according to TIM_861 Pin) Section 4.11	0001	STAT 1
F/DE (according to TIM_861 Pin) Section 4.11	0010	STAT 2
LOCKED Section 4.6	0011	STAT 3
Y/1ANC Section 4.16	0100	STAT 4
C/2ANC Section 4.16	0101	–
DATA ERROR Section 4.15	0110	STAT 5

Table 4-8: Output Signals Available on Programmable Multi-Function Pins (Continued)

Status Signal	Selection Code	Default Output Pin
$\overline{\text{VIDEO ERROR}}$	0111	–
$\overline{\text{AUDIO ERROR}}$	1000	–
EDH DETECTED	1001	–
CARRIER DETECT	1010	–
RATE_DET	1011	–

NOTE:

Each of the STAT[5:0] pins are configurable individually using the register bits in the host interface; STAT[5:0]_CONFIG (008h/009h).

4.11 H:V:F Timing Signal Generation

The GS1671 extracts critical timing parameters from the received TRS words.

Horizontal blanking (H), Vertical blanking (V), and Field odd/even (F) timing are output on the STAT[2:0] pins by default.

Using the H_CONFIG bit in the host interface, the H signal timing can be selected as one of the following:

1. Active line blanking (H_CONFIG = LOW) - the H output is HIGH for the horizontal blanking period, including the EAV TRS words.
2. TRS based blanking (H_CONFIG = HIGH) - the H output is set HIGH for the entire horizontal blanking period as indicated by the H bit in the received TRS signals.

The timing of these signals is shown in [Figure 4-6](#), [Figure 4-7](#), [Figure 4-8](#), [Figure 4-9](#), [Figure 4-10](#) and [Figure 4-11](#) below.

NOTE: Both 8-bit and 10-bit TRS words are identified by the device.

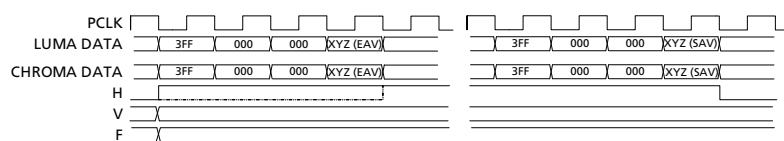

Figure 4-6: H:V:F Output Timing - HDTV 20-bit Mode

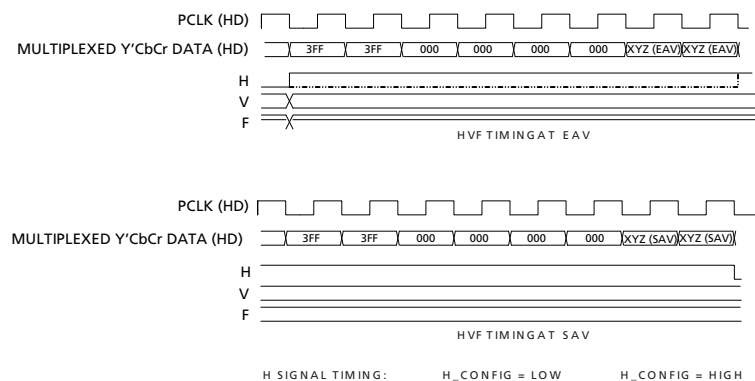

Figure 4-7: H:V:F Output Timing - HDTV 10-bit Mode

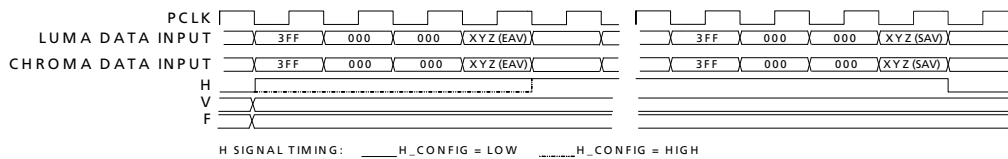

Figure 4-8: H:V:F Output Timing - HD 20-bit Output Mode

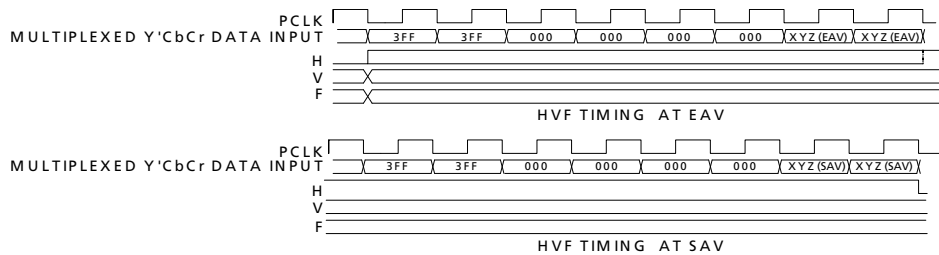

Figure 4-9: H:V:F Output Timing - HD 10-bit Output Mode

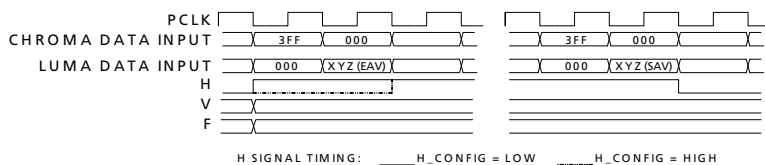

Figure 4-10: H:V:F Output Timing - SD 20-bit Output Mode

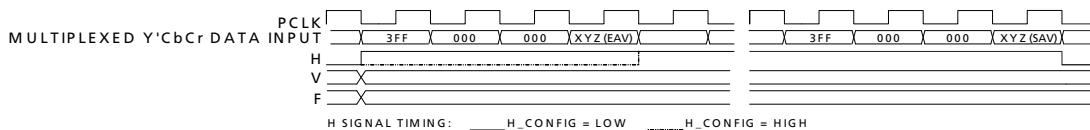

Figure 4-11: H:V:F Output Timing - SD 10-bit Output Mode

4.11.1 CEA-861 Timing Generation

The GS1671 is capable of generating CEA 861 timing instead of SMPTE HVF timing for all of the supported video formats.

This mode is selected when the TIM_861 pin is HIGH.

Horizontal sync (HSYNC), Vertical sync (VSYNC), and Data Enable (DE) timing are output on the STAT[2:0] pins by default.

Table 4-9 shows the CEA-861 formats supported by the GS1671:

Table 4-9: Supported CEA-861 Formats

Format	CEA-861 Format	VD_STD[5:0]
720(1440) x 480i @ 59.94/60Hz	6 & 7	16h, 17h, 19h, 1Bh
720(1440) x 576i @ 50Hz	21 & 22	18h, 1Ah
1280 x 720p @ 59.94/60Hz	4	20h, 00h
1280 x 720p @ 50Hz	19	24h, 04h
1920 x 1080i @ 59.94/60Hz	5	2Ah, 0Ah
1920 x 1080i @ 50Hz	20	2Ch, 0Ch
1920 x 1080p @ 29.97/30Hz	34 ¹	2Bh, 0Bh
1920 x 1080p @ 25Hz	33 ²	2Dh, 0Dh
1920 x 1080p @ 23.98/24Hz	32	30h, 10h

NOTES:
1,2: Timing is identical for the corresponding formats.

4.11.1.1 Vertical Timing

When CEA861 timing is selected, the device outputs standards compliant CEA861 timing signals as shown in the figures below; for example 240 active lines per field for SMPTE 125M.

The register bit TRS_861 is used to select DFP timing generator mode which follows the vertical blanking timing as defined by the embedded TRS code words. This setting is helpful for 525i. When TRS_861 is set LOW, DE will go HIGH for 480 lines out of 525. When TRS_861 is set HIGH, DE will go HIGH for 487 lines out of 525.

The timing of the CEA 861 timing reference signals can be found in the CEA 861 specifications. For information, they are included in the following diagrams. These diagrams may not be comprehensive.

Table 4-10: CEA861 Timing Formats

Format	Parameters
4	H:V:DE Input Timing 1280 x 720p @ 59.94/60Hz
5	H:V:DE Input Timing 1920 x 1080i @ 59.94/60Hz
6&7	H:V:DE Input Timing 720 (1440) x 480i @ 59.94/60Hz
19	H:V:DE Input Timing 1280 x 720p @ 50Hz
20	H:V:DE Input Timing 1920 x 1080i @ 50Hz
21&22	H:V:DE Input Timing 720 (1440) x 576 @ 50Hz
32	H:V:DE Input Timing 1920 x 1080p @ 23.94/24Hz
33	H:V:DE Input Timing 1920 x 1080p @ 25Hz
34	H:V:DE Input Timing 1920 x 1080p @ 29.97/30Hz

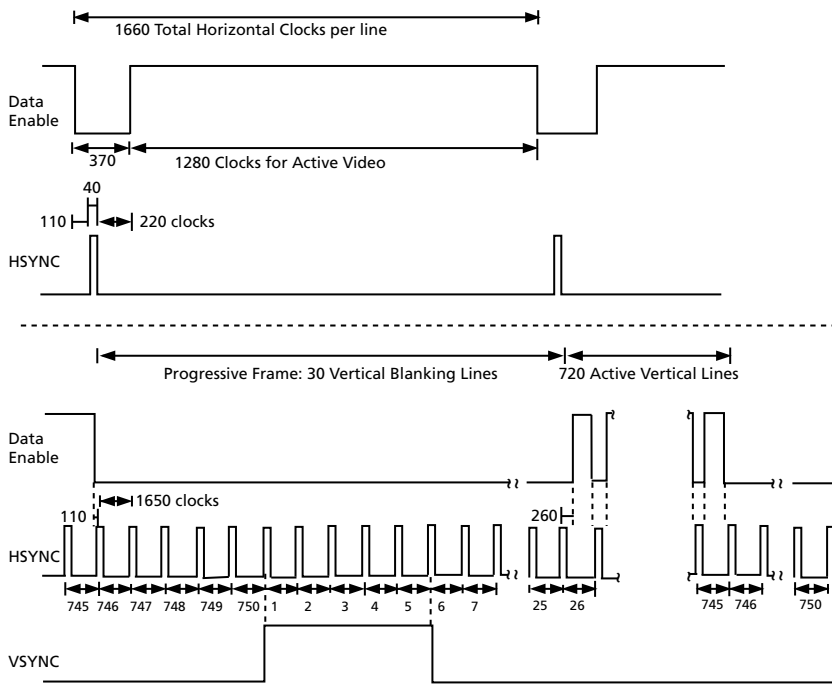

Figure 4-12: H:V:DE Output Timing 1280 x 720p @ 59.94/60 (Format 4)

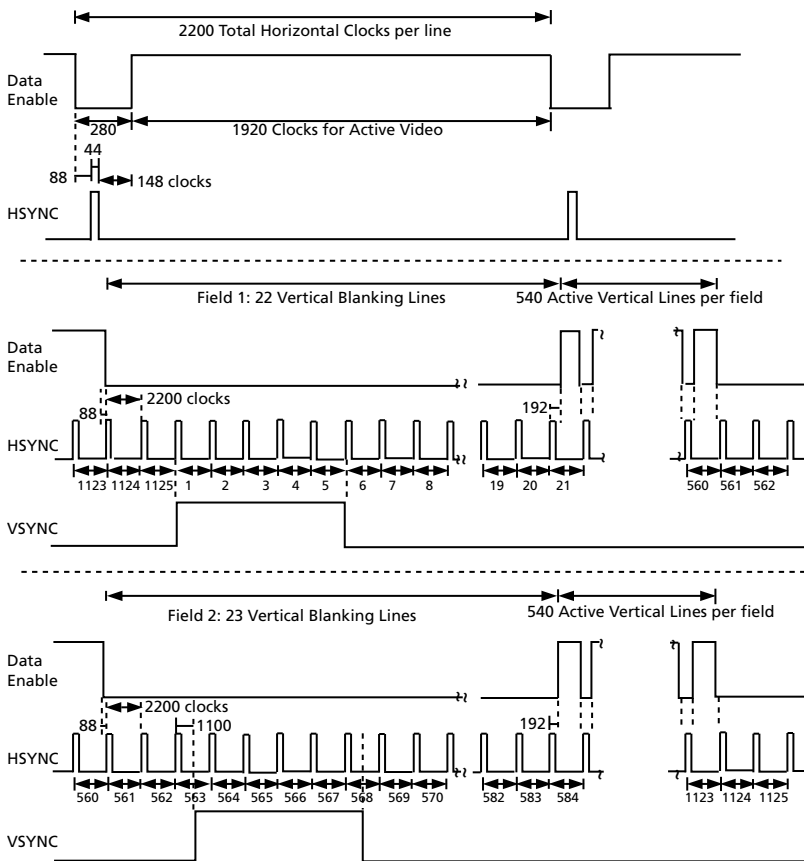

Figure 4-13: H:V:DE Output Timing 1920 x 1080i @ 59.94/60 (Format 5)

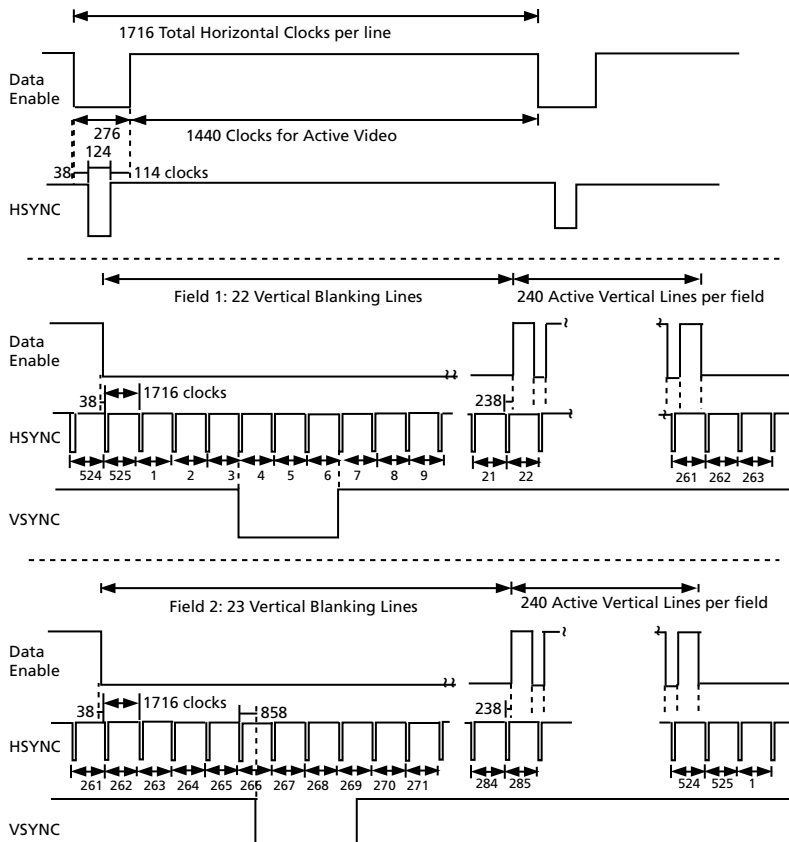

Figure 4-14: H:V:DE Output Timing 720 (1440) x 480i @ 59.94/60 (Format 6&7)

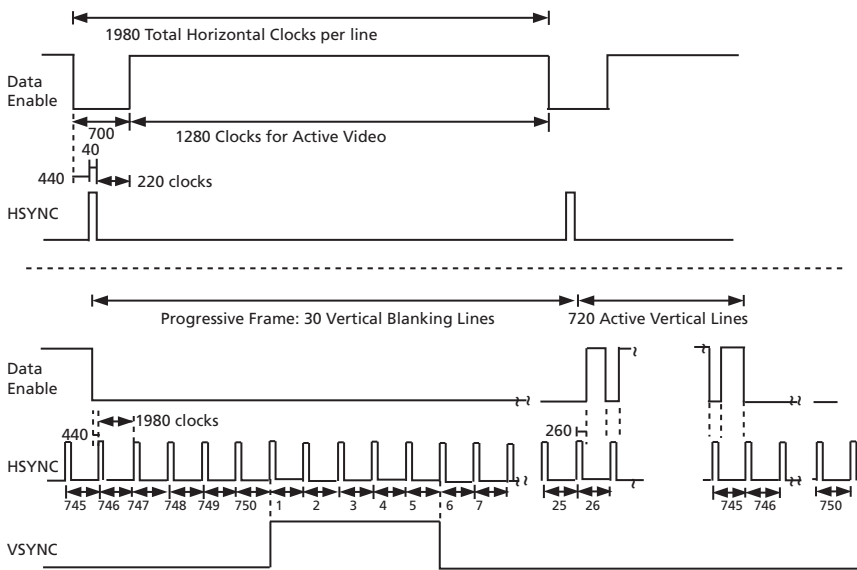

Figure 4-15: H:V:DE Output Timing 1280 x 720p @ 50 (Format 19)

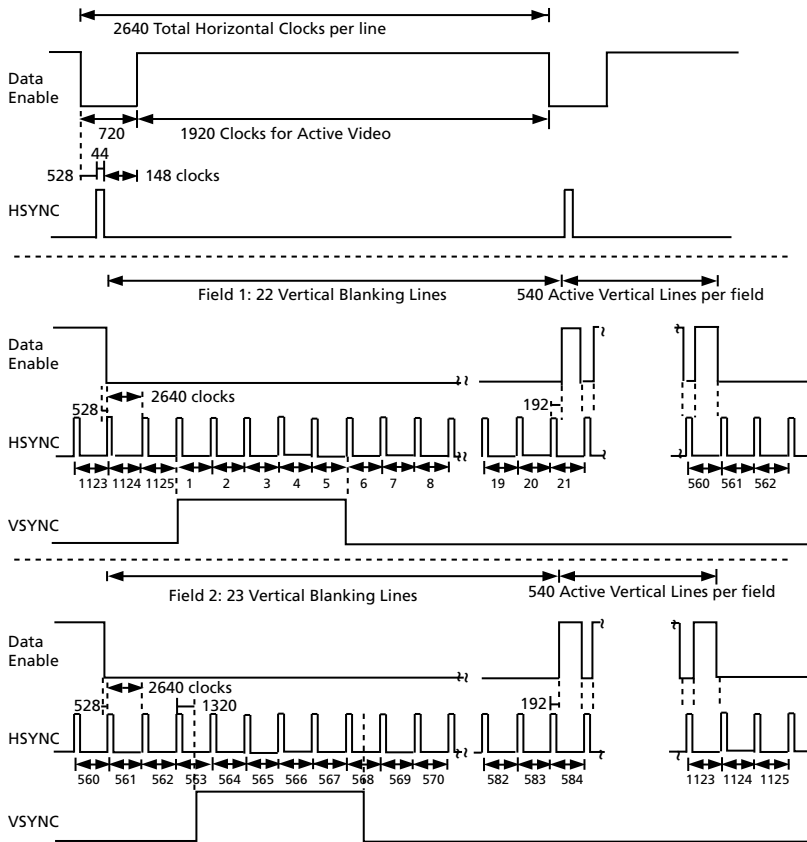

Figure 4-16: H:V:DE Output Timing 1920 x 1080i @ 50 (Format 20)

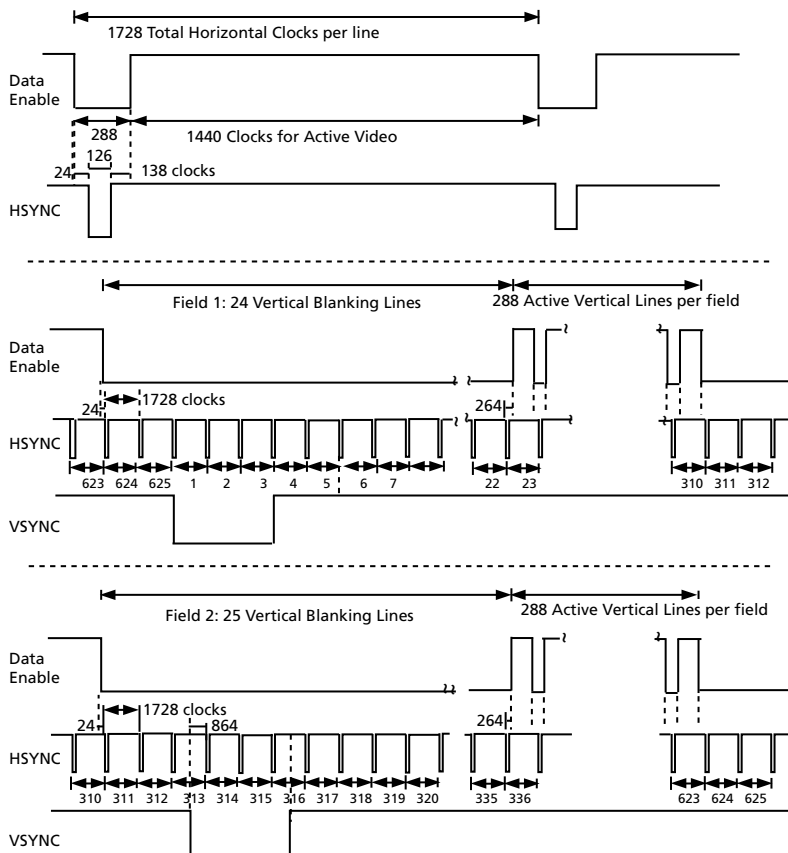

Figure 4-17: H:V:DE Output Timing 720 (1440) x 576 @ 50 (Format 21 & 22)

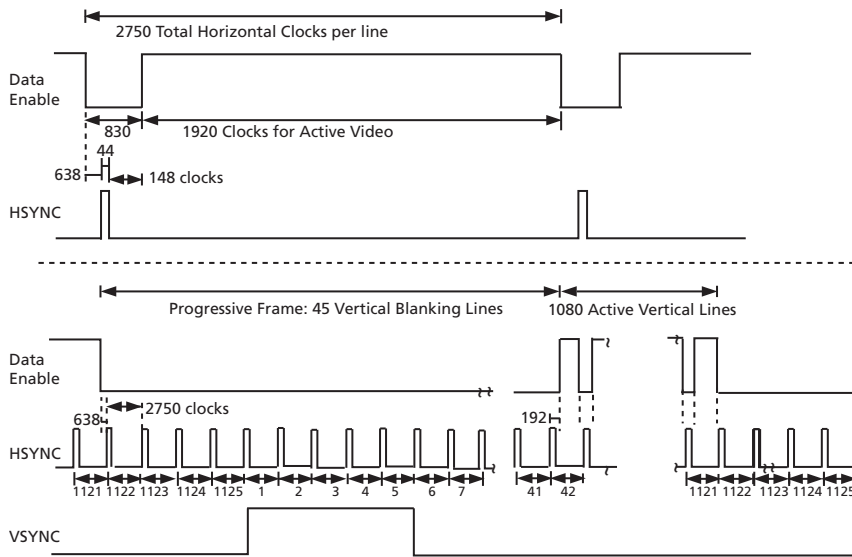

Figure 4-18: H:V:DE Output Timing 1920 x 1080p @ 23.94/24 (Format 32)

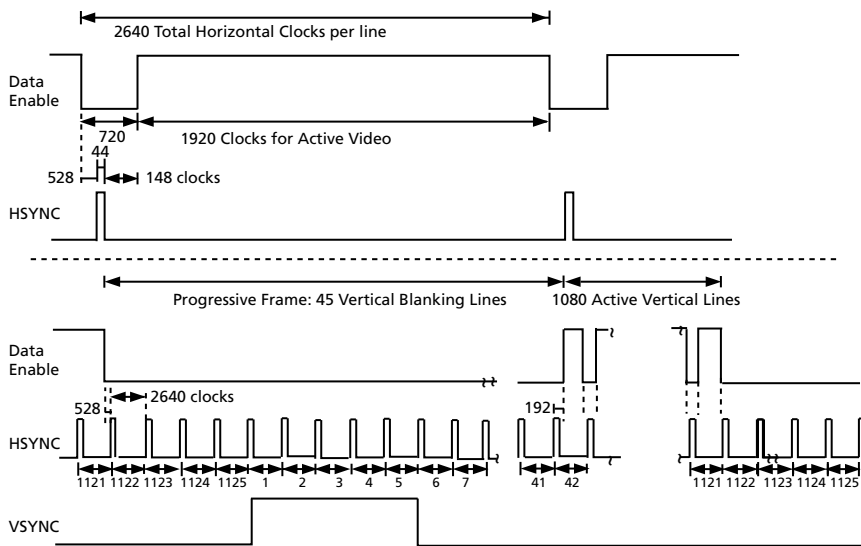

Figure 4-19: H:V:DE Output Timing 1920 x 1080p @ 25 (Format 33)

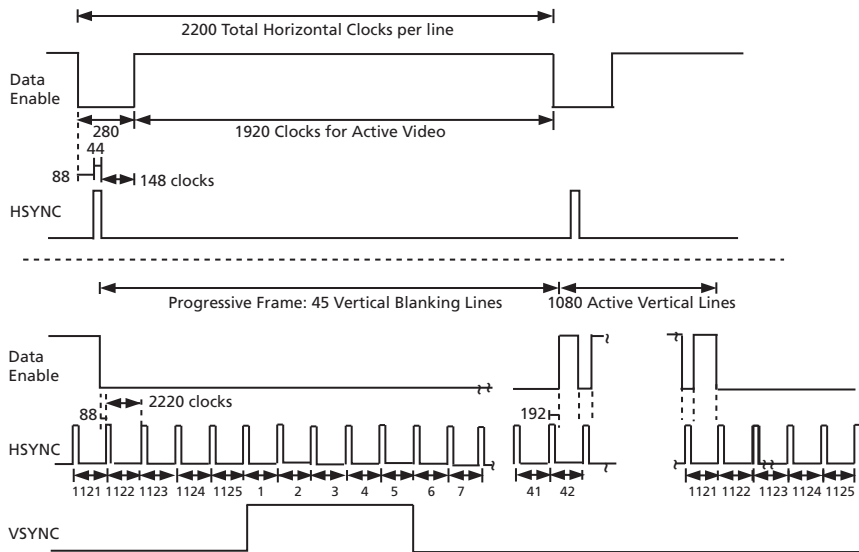

Figure 4-20: H:V:DE Output Timing 1920 x 1080p @ 29.97/30 (Format 34)

4.12 Automatic Video Standards Detection

Using the timing extracted from the received TRS signals, the GS1671 is able to identify the received video standard.

The total samples per line, active samples per line, total lines per field/frame and active lines per field/frame are all measured.

Four registers are provided to allow the system to read the video standard information from the device. These raster structure registers are provided in addition to the VIDEO_FORMAT_352_A_X and VIDEO_FORMAT_352_B_X registers, and are updated once per frame at the end of line 12.

The raster structure registers also contain three status bits: STD_LOCK, INT/ $\overline{\text{PROG}}$ and M. The STD_LOCK bit is set HIGH whenever the timing signal generator is fully synchronized to the incoming standard, and detects it as one of the supported formats. The INT/ $\overline{\text{PROG}}$ bit is set HIGH if the detected video standard is interlaced and LOW if the detected video standard is progressive. M is set HIGH if the clock frequency includes the “1000/1001” factor denoting a 23.98, 29.97 or 59.94Hz frame rate.

The video standard code is reported in the VD_STD bits of the host interface register.

Table 4-11 describes the 5-bit codes for the recognized video standards.

Table 4-11: Supported Video Standard Codes

SMPT E Standard	Active Video Area	RATE_ DET SD/HD	Lines per Frame	Active Lines per Frame	Words per Active Line	Words per Line	VD_STD [5:0]
260M (HD)	1920x1035/60 (2:1)	0	1125	1035	1920	2200	15h
295M (HD)	1920x1080/50 (2:1)	0	1250	1080	1920	2376	14h

Table 4-11: Supported Video Standard Codes (Continued)

SMPTE Standard	Active Video Area	RATE_ DET SD/HD	Lines per Frame	Active Lines per Frame	Words per Active Line	Words per Line	VD_STD [5:0]
274M (HD)	1920x1080/60 (2:1) or 1920x1080/30 (PsF)	0	1125	1080	1920	2200	0Ah
	1920x1080/50 (2:1) or 1920x1080/25 (PsF)	0	1125	1080	1920	2640	0Ch
	1920x1080/30 (1:1)	0	1125	1080	1920	2200	0Bh
	1920x1080/25 (1:1)	0	1125	1080	1920	2640	0Dh
	1920x1080/24 (1:1)	0	1125	1080	1920	2750	10h
	1920x1080/24 (PsF)	0	1125	1080	1920	2750	11h
	1920x1080/25 (1:1) – EM	0	1125	1080	2304	2640	0Eh
	1920x1080/25 (PsF) – EM	0	1125	1080	2304	2640	0Fh
	1920x1080/24 (1:1) – EM	0	1125	1080	2400	2750	12h
	1920x1080/24 (PsF) – EM	0	1125	1080	2400	2750	13h
296M (HD)	1280x720/30 (1:1) – EM	0	750	720	1280	3300	02h
	1280x720/30 (1:1) – EM	0	750	720	2880	3300	03h
	1280x720/50 (1:1)	0	750	720	1280	1980	04h
296M (HD)	1280x720/50 (1:1) – EM	0	750	720	1728	1980	05h
	1280x720/25 (1:1)	0	750	720	1280	3960	06h
	1280x720/25 (1:1) – EM	0	750	720	3456	3960	07h
	1280x720/24 (1:1)	0	750	720	1280	4125	08h
	1280x720/24 (1:1) – EM	0	750	720	3600	4125	09h
	1280x720/60 (1:1)	0	750	720	1280	1650	00h
	1280x720/60 (1:1) – EM	0	750	720	1440	1650	01h
125M (SD)	1440x487/60 (2:1)	1	525	244 or 243	1440	1716	16h
	1440x507/60	1	525	254 or 253	1440	1716	17h
	525-line 487 generic	1	525	–	–	1716	19h
	525-line 507 generic	1	525	–	–	1716	1Bh

Table 4-11: Supported Video Standard Codes (Continued)

SMPTE Standard	Active Video Area	RATE_DET SD/HD	Lines per Frame	Active Lines per Frame	Words per Active Line	Words per Line	VD_STD [5:0]
ITU-R BT.656 (SD)	1440x576/50 (2:1) Or dual link progressive)	1	625	–	1440	1728	18h
	625-line generic	1	625	–	–	1728	1Ah
Unknown HD	SD/HD = 0	0	–	–	–	–	1Dh
Unknown SD	SD/HD = 1	1	–	–	–	–	1Eh

Notes:

1. The Line Numbers in brackets refer to version zero SMPTE 352M packet locations, if they are different from version 1.
2. The part may provide full or limited functionality with standards that are not included in this table. Please consult a Semtech technical representative.
3. For SD-SDI streams, the device can report an incorrect M value when SMPTE-352M packets are present.

NOTE: In certain systems, due to greater ppm offsets in the crystal, the 'M' bit may not assert properly. In such cases, bits 3:0 in Register 06Fh can be increased to a maximum value of 4.

By default (after power up or after systems reset), the four RASTER_STRUCTURE, VD_STD, STD_LOCK and INT/PROG fields are set to zero. These fields are also cleared when the SMPTE_BYPASS pin is LOW.

4.13 Data Format Detection & Indication

In addition to detecting the video standard, the GS1671 detects the data format, i.e. SDTI, SDI, TDM data (SMPTE 346M), etc.

This information is represented by bits in the DATA_FORMAT_DSX register accessible through the host interface.

Data format detection is only carried out when the LOCKED signal is HIGH.

By default (at power up or after system reset), the DATA_FORMAT_DSX register is set to Fh (undefined). This register is also set as undefined when the LOCKED signal is LOW and/or the SMPTE_BYPASS pin is LOW.

Table 4-12: Data Format Register Codes

YDATA_FORMAT[3:0] or CDATA_FORMAT[3:0]	Data Format	Remarks
0h ~ 05h	SDTI	SMPTE 321M, SMPTE 322M, SMPTE 326M
6h	SDI	–
7h	Reserved	–

Table 4-12: Data Format Register Codes (Continued)

YDATA_FORMAT[3:0] or CDATA_FORMAT[3:0]	Data Format	Remarks
8h	TDM	SMPTE 346M
9h	HD-SDTI	–
Ah ~ Eh	Reserved	–
Fh	Non-SMPTE data format	Detected data format is not SMPTE. SMPTE_BYPASS = LOW or LOCKED = LOW

The data format is determined using the following criteria:

- If TRS ID words are detected but no SDTI header or TDM header is detected, then the data format is SDI
- If TRS ID words are detected and the SDTI header is available then the format is SDTI
- If TRS ID words are detected and the TDM data header is detected then the format is TDM video
- No TRS words are detected, but the PLL is locked, then the data format is unknown

NOTE: Two data format sets are provided for HD video rates. This is because the Y and Cr/Cb channels can be used separately to carry SDTI data streams of different data formats. In SD video mode, only the Y data format register contains the data, and the C register is set to Fh (undefined format).

4.14 EDH Detection

4.14.1 EDH Packet Detection

The GS1671 determines if EDH packets are present in the incoming video data and asserts the EDH_DETECT status according to the SMPTE standard.

EDH_DETECT is set HIGH when EDH packets have been detected and remains HIGH until EDH packets are no longer present. It is set LOW at the end of the vertical blanking (falling edge of V) if an EDH packet has not been detected during vertical blanking.

EDH_DETECT can be programmed to be output on the multi-function output port pins. The EDH_DETECT bit is also available in the host interface.

4.14.2 EDH Flag Detection

The EDH flags for ancillary data, active picture, and full field regions are extracted from the detected EDH packets and placed in the EDH_FLAG_IN register.

When the EDH_FLAG_UPDATE_MASK bit in the host interface is set HIGH, the GS1671 updates the Ancillary Data, Full Field, and Active Picture EDH flags according to SMPTE RP165. The updated EDH flags are available in the EDH_FLAG_OUT register. The EDH packet output from the device contains these updated flags.

One set of flags is provided for both fields 1 and 2. The field 1 flag data is overwritten by the field 2 flag data.

When EDH packets are not detected, the UES flags in the EDH_FLAG_OUT register are set HIGH to signify that the received signal does not support Error Detection and Handling. In addition, the EDH_DETECT bit is set LOW. These flags are set regardless of the setting of the EDH_FLAG_UPDATE_MASK bit.

EDH_FLAG_OUT and EDH_FLAG_IN may be read via the host interface at any time during the received frame except on the lines defined in SMPTE RP165, when these flags are updated.

The GS1671 indicates the CRC validity for both active picture and full field CRCs. The AP_CRC_V bit in the host interface indicates the active picture CRC validity, and the FF_CRC_V bit indicates the full field CRC validity. When EDH_DETECT = LOW, these bits are cleared.

The EDH_FLAG_OUT and EDH_FLAG_IN register values remain set until overwritten by the decoded flags in the next received EDH packet. When an EDH packet is not detected during vertical blanking, the flag registers are cleared at the end of the vertical blanking period.

4.15 Video Signal Error Detection & Indication

The GS1671 includes a number of video signal error detection functions. These are provided to enhance operation of the device when operating in SMPTE mode (SMPTE_BYPASS = HIGH). These features are not available in the other operating modes of the device (i.e. when SMPTE_BYPASS = LOW).

Signal errors that can be detected include:

1. TRS errors.
2. HD line based CRC errors.
3. EDH errors.
4. HD line number errors.
5. Video standard errors.

The device maintains an ERROR_STAT_X register. Each error condition has a specific flag in the ERROR_STAT_X register, which is set HIGH whenever an error condition is detected.

An ERROR_MASK register is also provided, allowing the user to select which error conditions are reported. Each bit of the ERROR_MASK register corresponds to a unique error type.

Separate SD_AUDIO_ERROR_MASK and HD_AUDIO_ERROR_MASK registers for SD and HD audio cores are also provided, allowing select error conditions to be reported. Each bit of each ERROR_MASK register corresponds to a unique error type.

By default (at power up or after system reset), all bits of the ERROR_MASK registers are zero, enabling all errors to be reported. Individual error detection may be disabled by setting the corresponding bit HIGH in the mask registers.

Error conditions are indicated by a $\overline{\text{VIDEO_ERROR}}$ signal and an $\overline{\text{AUDIO_ERROR}}$ signal, which are available for output on the multifunction I/O output pins. The two signals are also combined into a summary $\overline{\text{DATA_ERROR}}$ signal, which is also available on the multifunction I/O pins. These signals are normally HIGH, but are set LOW by the device when an error condition has been detected.

These signals are a logical 'NOR' of the appropriate error status flags stored in the ERROR_STAT_X register, which are gated by the bit settings in the ERROR_MASK registers. When an error status bit is HIGH and the corresponding error mask bit is LOW, the corresponding $\overline{\text{DATA_ERROR}}$ signal is set LOW by the device.

The ERROR_STAT_X registers, and correspondingly the $\overline{\text{DATA_ERROR}}$, $\overline{\text{VIDEO_ERROR}}$, and $\overline{\text{AUDIO_ERROR}}$ signals, are cleared at the start of the next video field or when read via the host interface, whichever condition occurs first. Note that any $\overline{\text{AUDIO_ERROR}}$ condition will cause $\overline{\text{DATA_ERROR}}$ to assert. Use the $\text{SD_AUDIO_ERROR_MASK}$ and $\text{HD_AUDIO_ERROR_MASK}$ registers if masking these events is desired.

All bits of the ERROR_STAT_X registers are also cleared under any of the following conditions:

1. $\overline{\text{LOCKED}}$ signal = LOW.
2. $\overline{\text{SMPTE_BYPASS}}$ = LOW.
3. When a change in video standard has been detected.
4. $\overline{\text{RESET_TRST}}$ = LOW

Table 4-13 shows the ERROR_STAT_X register and ERROR_MASK_X register.

NOTE: Since the error indication registers are cleared once per field, if an external host micro is polling the error registers periodically, an error flag may be missed if it is intermittent, and the polling frequency is less than the field rate.

Table 4-13: Error Status Register and Error Mask Register

Video Error Status Register	Video Error Mask Register
SAV_ERR (02h, 03h)	SAV_ERR_MASK (037h, 038h)
EAV_ERR (02h, 03h)	EAV_ERR_MASK (037h, 038h)
YCRC_ERR (02h, 03h)	YCRC_ERR_MASK (037h, 038h)
CCRC_ERR (02h, 03h)	CCRC_ERR_MASK (037h, 038h)
LNUM_ERR (02h, 03h)	LNUM_ERR_MASK (037h, 038h)
YCS_ERR (02h, 03h)	YCS_ERR_MASK (037h, 038h)
CCS_ERR (02h, 03h)	CCS_ERR_MASK (037h, 038h)
AP_CRC_ERR (02h)	AP_CRC_ERR_MASK (037h)
FF_CRC_ERR (02h)	FF_CRC_ERR_MASK (037h)
VD_STD_ERR (02h, 03h)	VD_STD_ERR_MASK (037h)

NOTE: See Section 4.18 for Audio Error Status.

4.15.1 TRS Error Detection

TRS error flags are generated by the GS1671 under the following two conditions:

1. A phase shift in received TRS timing is observed on a non-switching line.
2. The received TRS Hamming codes are incorrect.

Both SAV and EAV TRS words are checked for timing and data integrity errors.

For HD mode, only the Y channel TRS codes are checked for errors.

Both 8-bit and 10-bit TRS code words are checked for errors.

The SAV_ERR bit of the ERROR_STAT_X register is set HIGH when an SAV TRS error is detected.

The EAV_ERR bit of the ERROR_STAT_X register is set HIGH when an EAV TRS error is detected.

4.15.2 Line Based CRC Error Detection

The GS1671 calculates line based CRCs for HD video signals. CRC calculations are done for each 10-bit channel (Y and C for HD video).

These calculated CRC values are compared with the received CRC values.

If a mismatch in the calculated and received CRC values is detected for Y channel data, the YCRC_ERR bit in the ERROR_STAT_X register is set HIGH.

If a mismatch in the calculated and received CRC values is detected for C channel data, the CCRC_ERR bit in the ERROR_STAT_X register is set HIGH.

Y or C CRC errors are also generated if CRC values are not embedded.

Line based CRC errors are only generated when the device is operating in HD mode.

NOTE: By default, 8-bit to 10-bit TRS remapping is enabled. If an 8-bit input is used, the HD CRC check is based on the 10-bit remapped value, not the 8-bit value, so the CRC Error Flag is incorrectly asserted and should be ignored. If 8-bit to 10-bit remapping is enabled, then CRC correction and insertion should be enabled by setting the CRC_INS_MASK bit in the IOPROC_DISABLE register LOW. This ensures that the CRC values are updated.

4.15.3 EDH CRC Error Detection

The GS1671 also calculates Full Field (FF) and Active Picture (AP) CRC's according to SMPTE RP165 in support of Error Detection and Handling packets in SD signals.

These calculated CRC values are compared with the received CRC values.

Error flags for AP and FF CRC errors are provided and each error flag is a logical OR of field 1 and field 2 error conditions.

The AP_CRC_ERR bit in the VIDEO_ERROR_STAT_X register is set HIGH when an Active Picture CRC mismatch has been detected in field 1 or 2.

The FF_CRC_ERR bit in the VIDEO_ERROR_STAT_X register is set HIGH when a Full Field CRC mismatch has been detected in field 1 or 2.

EDH CRC errors are only indicated when the device is operating in SD mode and when the device has correctly received EDH packets.

4.15.4 HD Line Number Error Detection

If a mismatch in the calculated and received line numbers is detected, the LNUM_ERR bit in the VIDEO_ERROR_STAT_X register is set HIGH.

4.16 Ancillary Data Detection & Indication

The GS1671 detects ancillary data in both the vertical and horizontal ancillary data spaces. Status signal outputs Y/1ANC and C/2ANC are provided to indicate the position of ancillary data in the output data streams. These signals may be selected for output on the multi-function I/O port pins (STAT[5:0]).

The GS1671 indicates the presence of all types of ancillary data by detecting the 000h, 3FFh, 3FFh (00h, FFh, FFh for 8-bit video) ancillary data preamble.

NOTE: Both 8 and 10-bit ancillary data preambles are detected by the device.

By default (at power up or after system reset) the GS1671 indicates all types of ancillary data. Up to 5 types of ancillary data can be specifically programmed for recognition.

For HD video signals, ancillary data may be placed in both the Y and Cb/Cr video data streams separately. For SD video signals, the ancillary data is multiplexed and combined into the YCbCr data space.

When operating in HD mode, the Y/1ANC signal is HIGH whenever ancillary data is detected in the Luma data stream, and C/2ANC is HIGH whenever ancillary data is detected in the Chroma data stream. The signals are asserted HIGH at the start of the ancillary data preamble, and remain HIGH until after the ancillary data checksum.

When operating in SD mode, the Y/1ANC and C/2ANC signals depend on the output data format. For 20-bit demultiplexed data, the Y/1ANC and C/2ANC signals operate independently to indicate the first and last ancillary Data Word position in the Luma and/or Chroma data streams. For 10-bit multiplexed data, the Y/1ANC signal is HIGH whenever ancillary data is detected, and the C/2ANC signal is always LOW.

These status signal outputs are synchronous with PCLK and may be used as clock-enables for external logic, or as write-enables for an external FIFO or other memory devices.

The operation of the Y/1ANC and C/2ANC signals is shown below in [Figure 4-21](#).

NOTE: When I/O processing is disabled, the Y/1ANC and C/2ANC flags may toggle, but they are invalid and should be ignored.

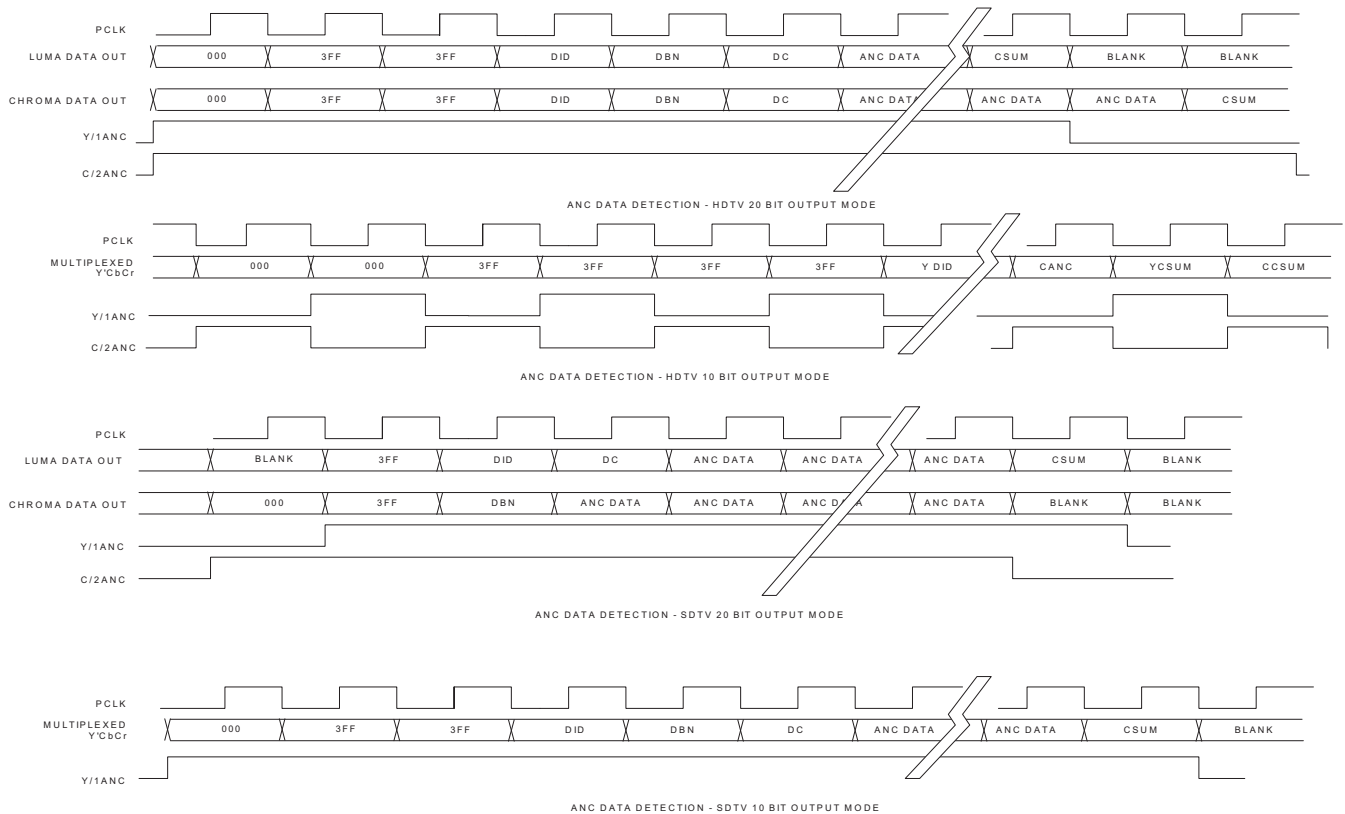

Figure 4-21: Y/1ANC and C/2ANC Signal Timing

4.16.1 Programmable Ancillary Data Detection

As described above in Section 4.16, the GS1671 detects and indicates all ancillary data types by default.

It is possible to program which ancillary data types are to be detected and indicated. Up to 5 different ancillary data types may be programmed for detection by the GS1671 in the ANC_TYPE_DS1 registers for SD and HD.

When so programmed, the GS1671 only indicates the presence of the specified ancillary data types, ignoring all other ancillary data. For each data type to be detected, the user must program the DID and/or SDID of that ancillary data type. In the case where no DID or SDID values are programmed, the GS1671 indicates the presence of all ancillary data. In the case where one or more, DID and/or SDID values have been programmed, then only those matching data types are detected and indicated.

The timing of the Y/1ANC and C/2ANC signals in this case is as shown in Figure 4-21.

The GS1671 compares the received DID and/or SDID with the programmed values. If a match is found, ancillary data is indicated.

For any DID or SDID value set to zero, no comparison or match is made. For example, if the DID is programmed and the SDID is not programmed, the GS1671 only detects a match to the DID value.

If both DID and SDID values are non-zero, then the received ancillary data type must match both the DID and SDID before Y/1ANC and/or C/2ANC is set HIGH.

NOTE: SMPTE 352M Payload Identifier packets and Error Detection and Handling (EDH) Packets are always detected by the GS1671, irrespective of the settings of the ANC_TYPE registers.

4.16.2 SMPTE 352M Payload Identifier

The GS1671 automatically extracts the SMPTE 352M payload identifier present in the input data stream for SD and HD. The four word payload identifier packets are written to VIDEO_FORMAT_X_DS1 and VIDEO_FORMAT_X_DS2 bits accessible through the host interface.

The device also indicates the version of the payload packet in the VERSION_352M bit of the DATA_FORMAT_DSX register. When the SMPTE 352M packet is formatted as a “version 1” packet, the VERSION_352M bit is set HIGH, when the packet is formatted as a “version 2” packet, this bit is set LOW.

The VIDEO_FORMAT_352_A_X and VIDEO_FORMAT_352_B_X registers are only updated if there are no checksum errors in the received SMPTE 352M packets.

By default (at power up or after system reset), the VIDEO_FORMAT_X_DS1 and VIDEO_FORMAT_X_DS2 bits are set to 0, indicating an undefined format.

4.16.2.1 SMPTE 352M Payload Identifier Usage

The SMPTE 352M Payload Identifier is used to confirm the video format identified by the Automatic Video Standards Detection block (see [Section 4.16.4](#))

4.16.3 Ancillary Data Checksum Error

The GS1671 calculates checksums for all received ancillary data.

These calculated checksums are compared with the received ancillary data checksum words.

If a mismatch in the calculated and received checksums is detected, then a checksum error is indicated.

When operating in HD mode, the device makes comparisons on both the Y and C channels separately. If an error condition in the Y channel is detected, the YCS_ERR bit in the VIDEO_ERROR_STAT_X register is set HIGH. If an error condition in the C channel is detected, the CCS_ERR bit in the VIDEO_ERROR_STAT_X register is set HIGH.

When operating in SD mode, only the YCS_ERR bit is set HIGH when checksum errors are detected.

4.16.3.1 Programmable Ancillary Data Checksum Calculation

As described above, the GS1671 calculates and compares checksum values for all ancillary data types by default. It is possible to program which ancillary data types are checked as described in [Section 4.16.1](#).

When so programmed, the GS1671 only checks ancillary data checksums for the specified data types, ignoring all other ancillary data.

The YCS_ERR and/or CCS_ERR bits in the VIDEO_ERROR_STAT_X register are only set HIGH if an error condition is detected for the programmed ancillary data types.

4.16.4 Video Standard Error

If a mismatch between the received SMPTE 352M packets and the calculated video standard occurs, the GS1671 indicates a video standard error by setting the VD_STD_ERR bit of the VIDEO_ERROR_STAT_X register HIGH.

The device detects the SMPTE 352M Packet version as defined in the SMPTE 352M standard. If the incoming packet is Version Zero, then no comparison is made with the internally generated payload information and the VD_STD_ERR bit is not set HIGH.

NOTE 1: If the received SMPTE 352M packet indicates 25, 30 or 29.97PsF formats, the device only indicates an error when the video format is actually progressive. The device detects 24 and 23.98PsF video standards and perform error checking at these rates.

NOTE 2: VD_STD_ERR_DS1 is set incorrectly for a 1920x1080/PsF/24 payload ID. To resolve this issue, choose one of the two methods.

- Set the VD_STD_ERR_DS1 mask bit high in the ERROR_MASK_1 register to avoid having incorrect assertion of the $\overline{\text{DATA_ERROR}}$ pin.
- Monitor the received SMPTE ST0352 packet in the VIDEO_FORMAT_352_A_1 and VIDEO_FORMAT_352_B_1 registers and compare that to the video format identified in the VD_STD_DS1 bits in the DATA_FORMAT_DS1 register. Then, make the determination of whether or not there is a mismatch on their own.

4.17 Signal Processing

In addition to error detection and indication, the GS1671 can also correct errors, inserting corrected code words, checksums and CRC values into the data stream.

The following processing can be performed by the GS1671:

1. TRS error correction and insertion.
2. HD line based CRC correction and insertion.
3. EDH CRC error correction and insertion.
4. HD line number error correction and insertion.
5. Illegal code re-mapping.
6. Ancillary data checksum error correction and insertion.
7. Audio extraction.

All of the above features are only available in SMPTE mode ($\overline{\text{SMPTE_BYPASS}} = \text{HIGH}$).

To enable these features, the IOPROC_EN/ $\overline{\text{DIS}}$ pin must be set HIGH, and the individual feature must be enabled via bits in the IOPROC_DISABLE register.

The IOPROC_DISABLE register contains one bit for each processing feature allowing each one to be enabled/disabled individually.

By default (at power up or after system reset), all of the IOPROC_DISABLE register bits are LOW, enabling all of the processing features.

To disable an individual processing feature, set the corresponding IOPROC_DISABLE bit HIGH in the IOPROC_DISABLE register.

Table 4-14: IOPROC_DISABLE Register Bits

Processing Feature	IOPROC_DISABLE Register Bit
TRS error correction and insertion	TRS_INS
Y and C line based CRC error correction	CRC_INS
Y and C line number error correction	LNUM_INS
Ancillary data check sum correction	ANC_CHECKSUM_INSERTION
EDH CRC error correction	EDH_CRC_INS
Illegal code re-mapping	ILLEGAL_WORD_REMAP
H timing signal configuration	H_CONFIG
Update EDH Flags	EDH_FLAG_UPDATE_MASK
Audio Data Extraction	AUDIO_SEL
Ancillary Data Extraction	ANC_DATA_EXT
Audio Extraction	AUD_EXT
Regeneration of 352M packets	REGEN_352M

4.17.1 TRS Correction & Insertion

When TRS Error Correction and Insertion is enabled, the GS1671 generates and overwrites TRS code words as required.

TRS Word Generation and Insertion is performed using the timing generated by the Timing Signal Generator, providing an element of noise immunity over using just the received TRS information.

This feature is enabled when the IOPROC_EN/ $\overline{\text{DIS}}$ pin is HIGH and the TRS_INS_DISABLE bit in the IOPROC_DISABLE register is set LOW.

NOTE: Inserted TRS code words are always 10-bit compliant, irrespective of the bit depth of the incoming video stream.

4.17.2 Line Based CRC Correction & Insertion

When CRC Error Correction and Insertion is enabled, the GS1671 generates and inserts line based CRC words into both the Y and C channels of the data stream.

Line based CRC word generation and insertion only occurs in HD mode, and is enabled in when the IOPROC_EN/ $\overline{\text{DIS}}$ pin is HIGH and the CRC_INS_DSX_MASK bit in the IOPROC_X register is set LOW.

4.17.3 Line Number Error Correction & Insertion

When Line Number Error Correction and Insertion is enabled, the GS1671 calculates and inserts line numbers into the output data stream. Re-calculated line numbers are inserted into both the Y and C channels.

Line number generation is in accordance with the relevant HD video standard as determined by the Automatic Standards Detection block.

This feature is enabled when the device is operating in HD mode, the IOPROC_EN/ $\overline{\text{DIS}}$ pin is HIGH and the LNUM_INS_DSX_MASK bit in the IOPROC_X register is set LOW.

4.17.4 ANC Data Checksum Error Correction & Insertion

When ANC data Checksum Error Correction and Insertion is enabled, the GS1671 generates and inserts ancillary data checksums for all ancillary data words by default.

Where user specified ancillary data has been programmed (see [Section 4.16.1](#)), only the checksums for the programmed ancillary data are corrected.

This feature is enabled when the IOPROC_EN/ $\overline{\text{DIS}}$ pin is HIGH and the ANC_CHECKSUM_INSERTION_DSX_MASK bit in the IOPROC_X register is set LOW.

4.17.5 EDH CRC Correction & Insertion

When EDH CRC Error Correction and Insertion is enabled, the GS1671 generates and overwrites full field and active picture CRC check-words.

Additionally, the device sets the active picture and full field CRC 'V' bits HIGH in the EDH packet. The AP_CRC_V and FF_CRC_V register bits only report the received EDH validity flags.

EDH FF and AP CRC's are only inserted when the device is operating in SD mode, and if the EDH data packet is detected in the received video data.

Although the GS1671 modifies and inserts EDH CRC's and EDH packet checksums, EDH error flags are only updated when the EDH_FLAG_UPDATE_MASK bit is LOW.

This feature is enabled in SD mode, when the IOPROC_EN/ $\overline{\text{DIS}}$ pin is HIGH and the EDH_CRC_INS_MASK bit in the IOPROC_1 register is set LOW.

4.17.6 Illegal Word Re-mapping

All words within the active picture (outside the horizontal and vertical blanking periods), between the values of 3FCh and 3FFh are re-mapped to 3FBh. All words within the active picture area between the values of 000h and 003h are remapped to 004h.

This feature is enabled when the IOPROC_EN/ $\overline{\text{DIS}}$ pin is HIGH and the ILLEGAL_WORD_REMAP_DSX_MASK bit in the IOPROC_X register is set LOW.

4.17.7 TRS and Ancillary Data Preamble Remapping

8-bit TRS and ancillary data preambles are re-mapped to 10-bit values. 8-bit to 10-bit mapping of TRS headers is only supported if the TRS values are 3FC 000 000. Other values such as 3FD, 3FE, 3FF, 001, 002 and 003 are not supported. This feature is enabled by default, and cannot be disabled via the IOPROC_X register.

4.17.8 Ancillary Data Extraction

Ancillary data may be extracted externally from the GS1671 output stream using the Y/1ANC and C/2ANC signals, and external logic.

As an alternative, the GS1671 includes a FIFO, which extracts ancillary data using read access via the host interface to ease system implementation. The FIFO stores up to 2048 x 16 bit words of ancillary data in two separate 1024 word memory banks.

The device writes the contents of ANC packets into the FIFO, starting with the first Ancillary Data Flag (ADF), followed by up to 1024 words.

All Data Identification (DID), Secondary Data Identification (SDID), Data Count (DC), user data, and checksum words are written into the device memory.

The device detects ancillary data packet DID's placed anywhere in the video data stream, including the active picture area.

Ancillary data from the Y channel or Data Stream One is placed in the Least Significant Word (LSW) of the FIFO, allocated to the lower 8 bits of each FIFO address.

Ancillary data from the C channel or Data Stream Two is placed in the Most Significant Word (MSW) (upper 8 bits) of each FIFO address.

NOTE: Please refer to the ANC insertion and Extraction Application Note (Doc ID: 53410), for discrete steps and example of Ancillary data extraction.

In SD mode, ancillary data is placed in the LSW of the FIFO. The MSW is set to zero.

If the ANC_TYPE registers are all set to zero, the device extracts all types of ancillary data. If programmable ancillary data extraction is required, then up to five types of ancillary data to be extracted can be programmed in the ANC_TYPE registers (see [Section 4.16.1](#)).

Additionally, the lines from which the packets are to be extracted can be programmed into the ANC_LINEA[10:0] and ANC_LINEB[10:0] registers, allowing ancillary data from a maximum of two lines per frame to be extracted. If only one line number register is programmed (with the other set to zero), ancillary data packets are extracted from one line per frame only. When both registers are set to zero, the device extracts packets from all lines.

To start Ancillary Data Extraction, the ANC_DATA_EXT_MASK bit of the host interface must be set LOW. Ancillary data packet extraction begins in the following frame (see [Figure 4-22: Ancillary Data Extraction - Step A](#)).

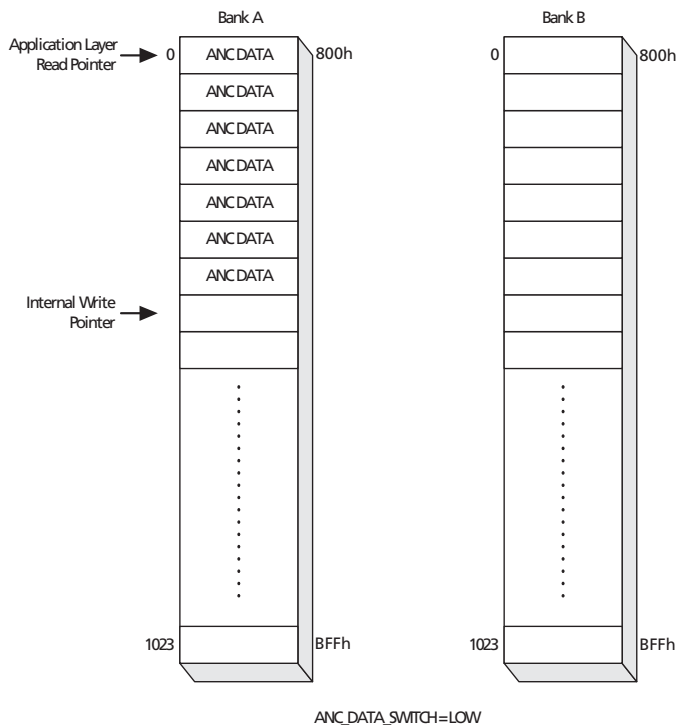

Figure 4-22: Ancillary Data Extraction - Step A

Ancillary data is written into Bank A until full. The Y/1ANC and C/2ANC output flags can be used to determine the length of the ancillary data extracted and when to begin reading the extracted data from memory.

While the ANC_DATA_EXT_MASK bit is set LOW, the ANC_DATA_SWITCH bit can be set HIGH during or after reading the extracted data. New data is then written into Bank B (up to 1024 x 16-bit words), using the corresponding host interface addresses (see [Figure 4-23: Ancillary Data Extraction - Step B](#)).

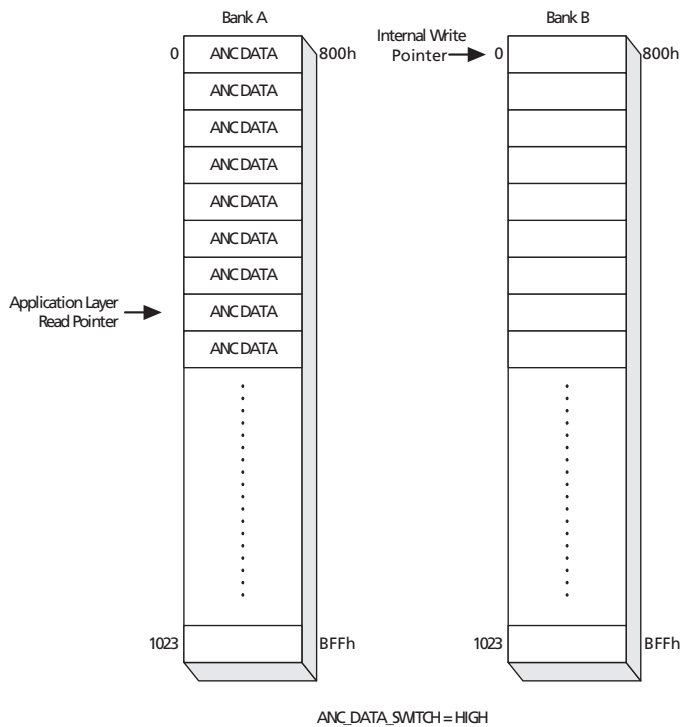

Figure 4-23: Ancillary Data Extraction - Step B

To read the new data, toggle the ANC_DATA_SWITCH bit LOW. The old data in Bank A is cleared to zero and extraction continues in Bank B (see [Figure 4-24: Ancillary Data Extraction - Step C](#)).

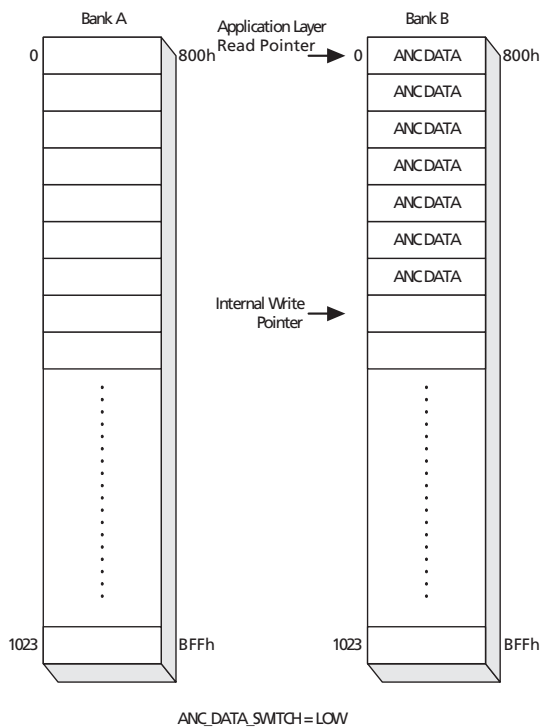

Figure 4-24: Ancillary Data Extraction - Step C

If the ANC_DATA_SWITCH bit is not toggled, extracted data is written into Bank B until full. To continue extraction in Bank A, the ANC_DATA_SWITCH bit must be toggled HIGH (see [Figure 4-25: Ancillary Data Extraction - Step D](#)).

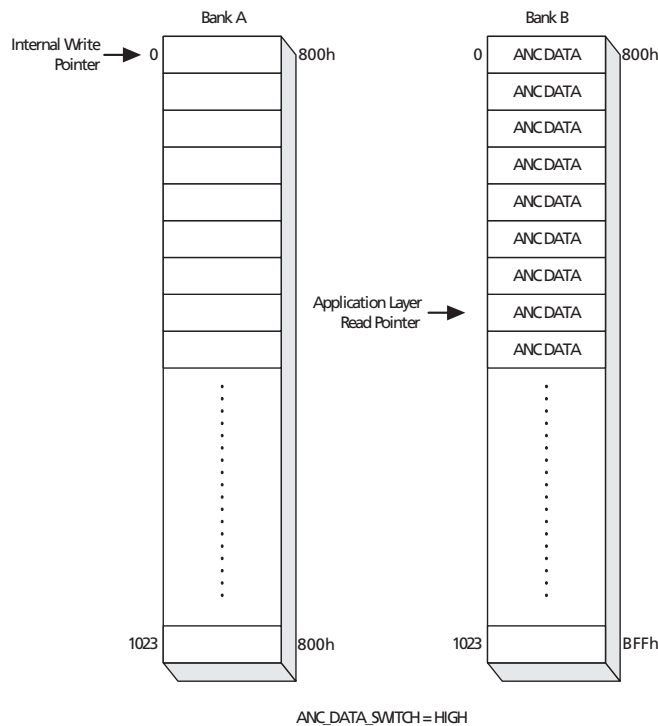

Figure 4-25: Ancillary Data Extraction - Step D

Toggling the ANC_DATA_SWITCH bit LOW returns the process to step A ([Figure 4-22](#)).

NOTE: Toggling the ANC_DATA_SWITCH must occur at a time when no extraction is taking place, i.e. when the both the Y/1ANC and C/2ANC signals are LOW.

To turn extraction off, the ANC_DATA_EXT_MASK bit must be set HIGH.

In HD mode, the device can detect ancillary data packets in the Luma video data only, Chroma video data only, or both. By default (at power-up or after a system reset), the device extracts ancillary data packets from the luma channel only.

To extract packets from the Chroma channel only, the HD_ANC_C2 bit of the host interface must be set HIGH. To extract packets from both Luma/Data Stream One and Chroma video data, the HD_ANC_Y1_C2 bit must be set HIGH (the setting of the HD_ANC_C2 bit is ignored).

The default setting of both the HD_ANC_C2 and HD_ANC_Y1_C2 is LOW. The setting of these bits is ignored when the device is configured for SD video standards.

Ancillary data packet extraction and deletion is disabled when the IOPROC_EN/DIS pin is set LOW.

After extraction, the ancillary data may be deleted from the video stream by setting the ANC_DATA_DEL bit of the host interface HIGH. When set HIGH, all existing ancillary data is removed and replaced with blanking values. If any of the ANC_TYPE registers are programmed with a DID and/or SDID, only the ancillary data packets with the matching IDs are deleted from the video stream.

NOTE 1: After the ancillary data determined by the ANC_TYPE_X_APX registers has been deleted, other existing ancillary data may not be contiguous. The device does not concatenate the remaining ancillary data.

NOTE 2: Reading extracted ancillary data from the host interface must be performed while there is a valid video signal present at the serial input and the device is locked (LOCKED signal is HIGH).

4.18 Audio De-embedder

The GS1671 includes an integrated audio de-embedder which is enabled by default in SMPTE mode. It can be disabled by setting the AUDIO_EN/ $\overline{\text{DIS}}$ pin LOW, or by setting the host interface AUD_EXT_MASK bit to HIGH, or by keeping IOPROC_EN/ $\overline{\text{DIS}}$ pin LOW. In non-SMPTE modes, the audio de-embedder is not active.

Up to eight channels of audio may be extracted from the received serial digital video stream. The output signal formats supported by the device include AES/EBU, I²S (default) and industry standard serial digital formats.

16, 20 and 24-bit audio bit depths are supported for 48kHz synchronous audio for SD data rates. For HD data rate, 16, 20 and 24-bit audio bit depths are supported for 48kHz audio. The audio may be synchronous or asynchronous to the video.

Additional audio processing features include audio mute on loss of lock, de-embed and delete, group selection, audio output re-mapping, ECC error detection and correction (HD mode only), and audio channel status extraction.

4.18.1 Serial Audio Data I/O Signals

The Serial Audio Data I/O pins are listed in [Table 4-15: Serial Audio Pin Descriptions](#).

Table 4-15: Serial Audio Pin Descriptions

Audio	
Pin Name	Description
AUDIO_EN/ $\overline{\text{DIS}}$	Enable Input for Audio Processing
AOUT_1/2	Serial Audio output; Channels 1 and 2
AOUT_3/4	Serial Audio output; Channels 3 and 4
AOUT_5/6	Serial Audio Output; Channels 5 and 6
AOUT_7/8	Serial Audio Output; Channels 7 and 8
ACLK	64fs clock
WCLK	Word clock
AMCLK	Audio Master Clock, selectable 128fs, 256fs, or 512fs

The timing of the serial audio output signals, the WCLK output signal, and the ACLK output signal is as shown in Figure 4-26: ACLK to Data Signal Output Timing.

I/O Timing Specs:

Audio Outputs:

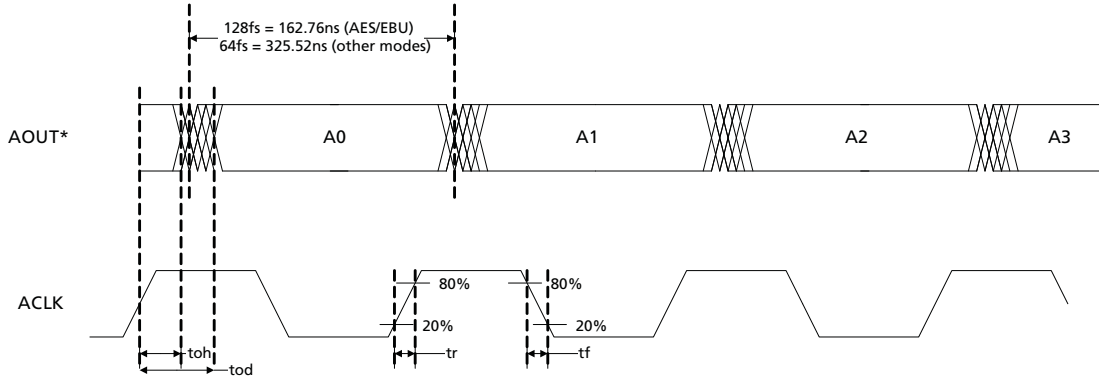

	3.3V						1.8V					
	toh	tr/tf (min)	Cload	tod	tr/tf (max)	Cload	toh	tr/tf (min)	Cload	tod	tr/tf (max)	Cload
AOUT	1.500ns	0.600ns	6 pF	7.000ns	2.200ns	15 pF	1.500ns	0.600ns	6 pF	7.000ns	2.300ns	15 pF

Figure 4-26: ACLK to Data Signal Output Timing

When AUDIO_EN/ $\overline{\text{DIS}}$ is set HIGH, audio extraction is enabled and the audio output signals are extracted from the video data stream. When set LOW, the serial audio outputs, ACLK and WCLK outputs are set LOW.

In addition, all functional logic associated with audio extraction is disabled to reduce power consumption.

4.18.2 Serial Audio Data Format Support

The GS1671 supports the following serial audio data formats:

- I²S (default)
- AES/EBU
- Serial Audio Left Justified, MSB First
- Serial Audio Left Justified, LSB First
- Serial Audio Right Justified, MSB First
- Serial Audio Right Justified, LSB First (this mode is not supported in SD)

By default (at power up or after system reset) I²S is selected. The other data formats are selectable via the host interface using the AMA/AMB[1:0] bits.

Table 4-16: Audio Output Formats

AMA/AMB[1:0]	Audio Output Format
00	AES/EBU audio output
01	Serial audio output: Left Justified; MSB first
10	Serial audio output: Right Justified; MSB first
11	I ² S (Default)

The serial audio output formats may use LSB first according to the settings of the control bits LSB_FIRSTA, LSB_FIRSTB, LSB_FIRSTC, and LSB_FIRSTD. When in I²S mode, these control bits must all be set LOW (default).

When I²S format is desired, both groups must be set to I²S (i.e. AMA = AMB = 11). This is because they share the same WCLK.

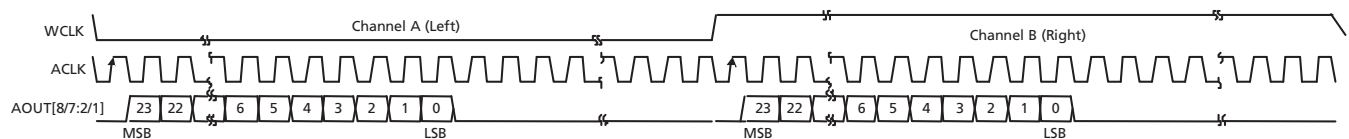

Figure 4-27: I²S Audio Output Format

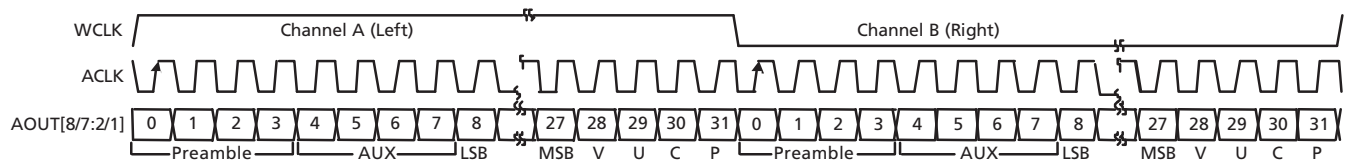

Figure 4-28: AES/EBU Audio Output Format

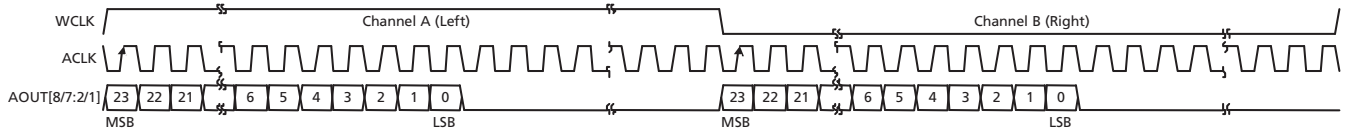

Figure 4-29: Serial Audio, Left Justified, MSB First

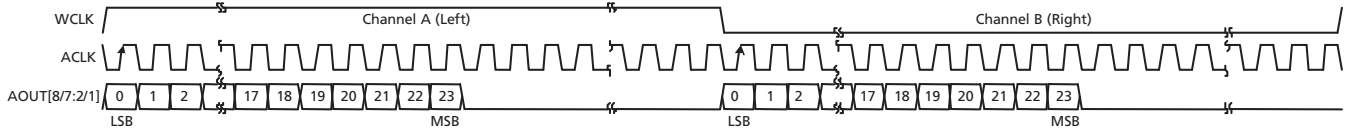

Figure 4-30: Serial Audio, Left Justified, LSB First

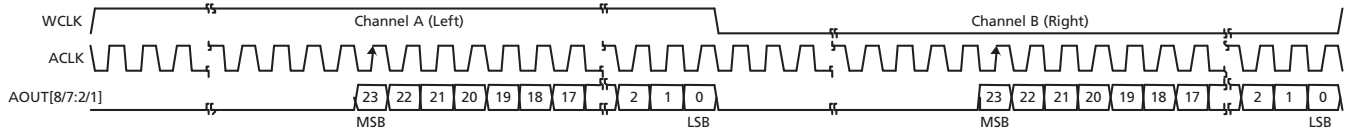

Figure 4-31: Serial Audio, Right Justified, MSB First

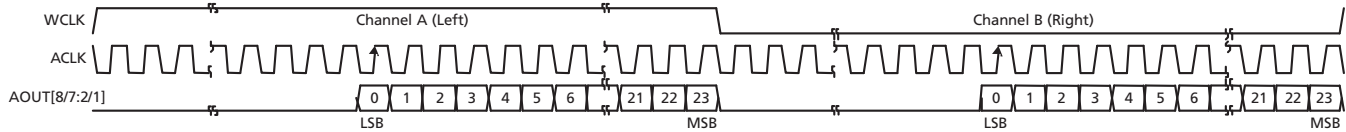

Figure 4-32: Serial Audio, Right Justified, LSB First

4.18.2.1 AES/EBU Mode

In AES/EBU output mode, the audio de-embedder uses a 128fs (6.144MHz audio bit clock) clock as shown in [Figure 4-33](#).

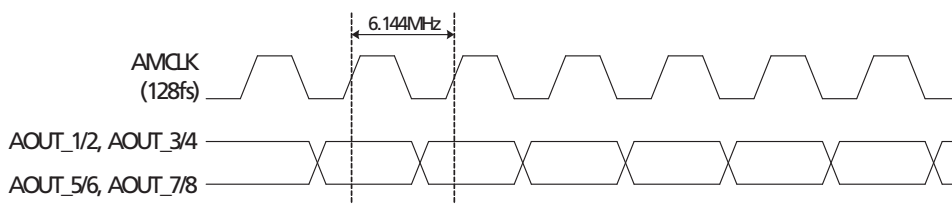

Figure 4-33: AES/EBU Audio Output to Bit Clock Timing

4.18.2.2 Audio Data Packet Extraction Block

The audio de-embedder looks for audio data packets on every line of the incoming video.

The audio data must be embedded according to SMPTE 272M (SD) or SMPTE 299M (HD).

The Audio Group Detect registers are set HIGH when audio data packets with a corresponding group DID are detected in the input video stream. The host interface reports the individual audio groups detected.

Table 4-17: Audio Data Packet Detect Register

Name	Description	Default
ADPG4_DET	Audio Group Four Data Packet Detection (1: Detected)	0
ADPG3_DET	Audio Group Three Data Packet Detection (1: Detected)	0
ADPG2_DET	Audio Group Two Data Packet Detection (1: Detected)	0
ADPG1_DET	Audio Group One Data Packet Detection (1: Detected)	0

When an audio data packet with a DID set in IDA[1:0] and IDB[1:0] is detected, the audio sample information is extracted and written into the audio FIFO.

The embedded audio group selected by IDA[1:0] is described henceforth in this document as Group A or Primary Group. The embedded audio group selected by IDB[1:0] is described henceforth in this document as Group B or Secondary Group.

Due to the large size of the horizontal ancillary data space in 720p/24, 720p/25 and 720p/30 video standards, the maximum number of ancillary data words the audio de-embedder can process is limited to 1024 when configured for these standards.

4.18.2.3 Audio Control Packets

The audio de-embedder automatically detects the presence of audio control packets in the video stream. When audio control packets for audio Group A are detected, the CTRA_DET bit of the host interface is set HIGH. When audio control packets for audio Group B are detected, the CTRB_DET bit of the host interface is set HIGH.

The audio control packet data is accessible via the host interface.

The audio control packets must be embedded according to SMPTE 272M (SD) or SMPTE 299M (HD).

NOTE: In SD, the control packet host interface registers are updated with new control packet values, after the CTRA_DET/CTRB_DET flags are cleared. In HD, the update happens automatically.

4.18.2.4 Setting Packet DID

Table 4-18 below, shows the 2-bit host interface setting for the audio group DID's.

For 24-bit audio support in SD mode, extended audio packets for Group A must have the same group DID set in IDA[1:0] of the host interface. Extended audio packets for Group B must have the same group DID set in IDB[1:0] of the host interface.

The audio de-embedder automatically detects the presence of extended audio packets. When detected, the audio output format is set to 24-bit audio sample word length.

The audio de-embedder defaults to audio Groups One and Two, where Group A is extracted from packets with audio Group One DID, and Group B from packets with audio Group Two DID.

Table 4-18: Audio Group DID Host Interface Settings

Audio Group	SD Data DID	SD Extended DID	HD Data DID	SD Control DID	HD Control DID	Host Interface Register Setting (2-bit)
1	2Fh	1FEh	2E7h	1EFh	1E3h	00b
2	1FDh	2FCh	1E6h	2EEh	2E2h	01b
3	1FBh	2FAh	1E5h	2EDh	2E1h	10b
4	2F9h	1F8h	2E4h	1ECh	1E0h	11b

Table 4-19: Audio Data and Control Packet DID Setting Register

Name	Description	Default
IDA[1:0]	Group A Audio data and control packet DID setting	00b
IDB[1:0]	Group B Audio data and control packet DID setting	01b

4.18.2.5 Audio Packet Delete Block

To delete all ancillary data with a group DID shown in [Table 4-18](#), the ALL_DEL bit in the host interface must be set HIGH.

4.18.2.6 ECC Error Detection & Correction Block (HD Mode Only)

The audio de-embedder performs BCH(31,25) forward error detection and correction, as described in SMPTE 299M. The error correction for all embedded audio data packets is activated when the host interface ECC_OFF bit is set LOW (default LOW). The audio de-embedder corrects any errors in both the audio output and the embedded packet.

When a one-bit error is detected in a bit array of the ECC protected region of the audio data packet with audio group DID set in IDA[1:0], the ECCA_ERROR flag is set HIGH. When a one-bit error is detected in the ECC protected region of the audio data packet with audio group DID set in IDB[1:0], the ECCB_ERROR flag is set HIGH.

[Figure 4-34](#) shows examples of error correction and detection. Up to 8 bits in error can be corrected, providing each bit error is in a different bit array (shown below). When there are two or more bits in error in the same 24-bit array, the errors are detected, but not corrected.

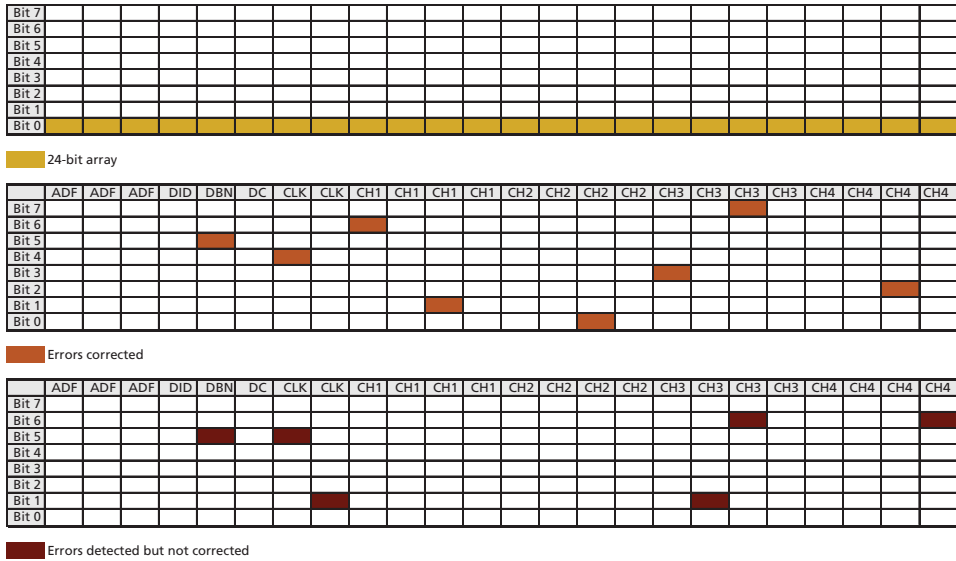

Figure 4-34: ECC 24-bit Array and Examples

4.18.3 Audio Processing

4.18.3.1 Audio Clock Generation

For SD and HD audio, a single set of audio frequencies is generated for all audio channels, using a Direct Digital Period Synthesizer (DDPS) to minimize jitter.

In SD mode, audio clocks are derived from the PCLK.

In HD mode, the input control for the DDPS is derived from the two embedded audio clock phase words in the audio data packet corresponding to Group A. The audio clock phase information used is taken from the first embedded audio packet in the HANC space. With no embedded audio present, the device will not generate ACLK or WCLK. The IGNORE_PHASE bit should be asserted in this case to ensure the proper AMCLK frequency is generated.

The audio de-embedder also includes a Flywheel block to overcome any inconsistencies in the embedded audio clock phase information.

If the audio phase data is not present in the audio data packets, or is incorrect, the NO_PHASEA_DATA bit in the host interface is set and the clock will free-run based on the detected video format, the PCLK and the M value. IGNORE_PHASE should be set HIGH when NO_PHASEA_DATA is set. This does not occur automatically.

When the IGNORE_PHASE bit in the host interface is set HIGH, it is recommended that the M value be programmed via the host interface. This can be done by setting the FORCE_M bit HIGH, and programming the desired value into FORCE_MEQ1001. The correct value can be obtained by reading the M bit from the Video Core Registers.

If the DDPS is locked to phase data and audio data packets are lost or corrupted, the Clock Generator will flywheel for up to four audio data packets. If no valid audio data packet with valid phase data is provided within this time, the Clock Generator will free-run based on the video format, the PCLK and the M value.

If the IGNORE_PHASE bit in the host interface is HIGH, the clock will free-run based on the video format, the PCLK and the M value, independent of the NO_PHASEA_DATA bit.

In the 720p/24 video format, the total line length is 4125 pixels, which requires a resolution of 13 bits for the audio clock phase words in the embedded audio data packets. SMPTE 299M only specifies a maximum of 12 bits resolution. Proposed changes to SMPTE 299M suggest using bit 5 of UDW1 (currently reserved and set to zero) in the audio data packet as the MSB (ck13) for the audio clock phase data, providing 13 bits resolution.

Some audio encoders may hold the clock phase value at a maximum value when reached, until reset at the end of the line. This produces a small amount of audio phase jitter for the period of one sample.

To overcome this issue, the audio de-embedder checks for all cases. On detection of the maximum value, a comparison is made between previous clock phases and the correct position interpolated. If the clock phase data value starts to decrease, the de-embedder checks to see if bit 5 (ck13) of UDW1 in the audio data packet is set. If ck13 is set, the correct value is used. If ck13 is not set, the correct position is interpolated.

4.18.3.2 Detect 5-Frame Sequence Block

5-frame sequence detection is required for 525-line based video formats only. The audio de-embedder checks the Audio Frame Number sequence in the audio control packets, when present. If the audio frame sequence is running (repeated 1 to 5 count), the audio de-embedder uses this information to determine the 5-frame sequence. If the audio control packet is not present, or the Audio Frame Number words are set to 200h, the audio de-embedder detects the 5-frame sequence by counting the number of samples per frame. Figure 4-35 shows the number of samples per frame over a 5-frame sequence.

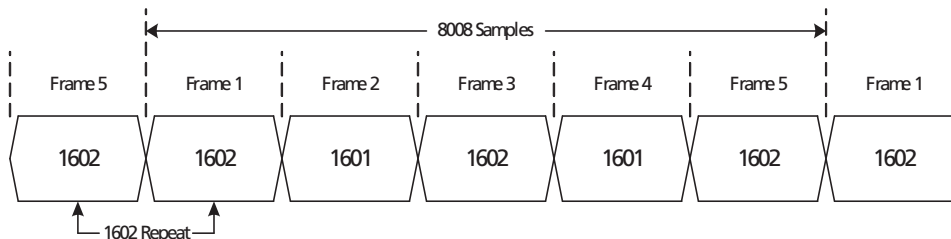

Figure 4-35: Sample Distribution over 5 Video Frames (525-line Systems)

When the audio inputs are asynchronously switched or disrupted, the audio de-embedder continues to write audio samples into the audio buffer, based on the current 5-frame sequence. The de-embedder then re-locks to the new 5-frame sequence, at which point a sample may be lost.

NOTE: In SD, all four channel pairs must follow the same 5-frame sequence.

4.18.3.3 Audio FIFO Block

The function of the FIFO block is to change the audio data word rate from the ANC rate multiplexed with the video signal to the 48kHz audio output rate.

The audio FIFO block contains the audio sample buffers; one per audio channel. Each buffer is 36 audio samples deep. At power up or reset, the read pointer is held at the zero position until 26 samples have been written into the FIFO (allows for 6 lines per frame with no audio samples; a maximum of 4 samples per line in SD Mode). See [Figure 4-36](#).

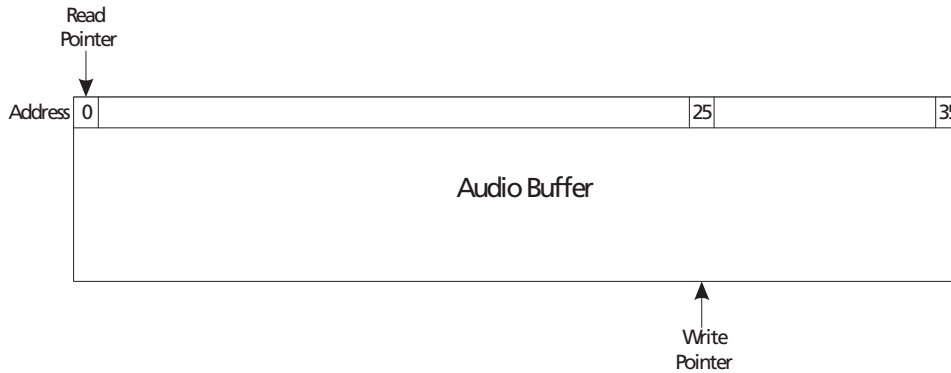

Figure 4-36: Audio Buffer After Initial 26 Sample Write

The position of the write pointer with respect to the read pointer is monitored continuously. If the write pointer is less than 6 samples ahead of the read pointer (point A in [Figure 4-37](#)), a sample is repeated from the read-side of the FIFO. If the write pointer is less than 6 samples behind the read pointer (point B in [Figure 4-37](#)), a sample is dropped. This avoids buffer underflow/overflow conditions.

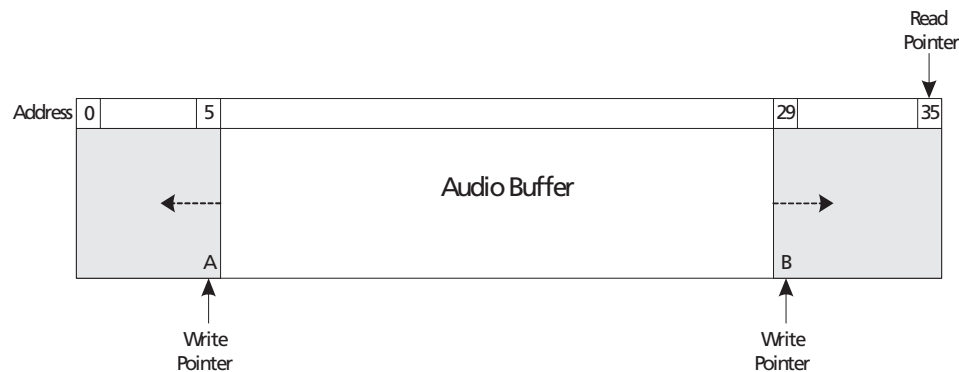

Figure 4-37: Audio Buffer Pointer Boundary Checking

The repeat or drop sample operation is performed a maximum of 28 consecutive times, after which the audio outputs are muted (all sample data set to zero). In SD Mode, 26 samples are required to be written into the FIFO prior to starting the read operation again.

The audio buffer pointer offset may be reduced from 26 samples to 12 or 6 samples using the OS_SEL[1:0] bits in the host interface. The default setting is 26 samples (see [Table 4-20](#)).

When the OS_SEL[1:0] bits are set for 6-sample pointer offset, no boundary-checking is performed.

In HD mode the audio FIFO is a maximum of 10 samples deep. According to SMPTE 299M, audio samples are multiplexed immediately in the next HANC region after the audio sample occurs.

Table 4-20: Audio Buffer Pointer Offset Settings

OS_SEL[1:0]	Buffer Pointer Offset
00	26 samples (default)
01	12 samples
10	6 samples

4.18.3.4 Audio Crosspoint Block

The Audio Crosspoint is used for audio output channel re-mapping. This feature allows any of the selected audio channels in Group A or Group B to be output on any of the eight output channels. The default setting is for one to one mapping, where AOUT_1/2 is extracted from Group A CH1 and CH2, AOUT_3/4 is extracted from Group A CH3 and CH4, and so on.

NOTE: If audio samples from embedded audio packets with the group set in IDA[1:0] are to be paired with samples from the group set in IDB[1:0], all of the channels must have been derived from the same Word Clock and must be synchronous.

The output channel is set in the OPn_SRC[2:0] host interface registers. [Table 4-21](#) lists the 3-bit address for audio channel mapping.

Table 4-21: Audio Channel Mapping Codes

Audio Output Channel	3-bit Host Interface Source Address
1	000
2	001
3	010
4	011
5	100
6	101
7	110
8	111

4.18.3.5 Serial Audio Output Word Length

The audio output, in serial modes, has a selectable 24, 20 or 16-bit sample word length. The ASWL[1:0] host interface register is used to configure the audio output sample word length. Figure 4-22 shows the host interface 2-bit code for setting the audio sample word length. When the presence of extended audio packets is detected in SD modes, the audio de-embedder defaults to 24-bit audio sample word length.

Table 4-22: Audio Sample Word Lengths

ASWL[1:0]	Audio Sample Word Length (SD)	Audio Sample Word Length (HD)
00	24-bit	24-bit
01	20-bit	20-bit
10	16-bit	16-bit
11	Auto 24/20-bit (Default)	Reserved (Default)*

*NOTE: By default, for HD at power-up, the word length is invalid. The desired word length should be programmed through the host interface.

4.18.3.6 Audio Channel Status

The GS1671 detects the AES/EBU Audio Channel Status (ACS) block information for each of the selected channel pairs.

ACS data detection is indicated by corresponding ACS_DET flag bits in the host interface. The flag is cleared by writing to the same location.

Audio Channel Status Read

AES/EBU ACS data is available separately for each of the channels in a stereo pair. The GS1671 defaults to reading the first channel of each pair. There are 184 bits in each ACS packet, which are written to twelve 16-bit right-justified registers in the host interface.

The ACS_USE_SECOND bit (default LOW) selects the second channel in each audio pair when set HIGH.

Once all of the ACS data for a channel has been acquired, the corresponding ACS_DET bit is set, and acquisition stops. The ACS data is overwritten with new data when the ACS_DET bit is cleared in the system.

Audio Channel Status Regeneration

When the ACS_REGEN bit in the host interface is set HIGH, the audio de-embedder embeds the 24 bytes of the Audio Channel Status information programmed in the ACSR[183:0] registers into the 'C' bit of the AES/EBU outputs. The same Audio Channel Status information is used for all output channels.

In order to apply ACSR data;

- Set the ACS_REGEN bit to logic HIGH
- Write the desired ACSR data to the ACSR registers

- Set the ACS_APPLY bit to HIGH

At the next status boundary, the device outputs the contents of the ACSR registers as ACS data. This event may occur at a different time for each of the output channels. While waiting for the status boundary, the device sets the appropriate ACS_APPLY_WAIT[A:D] flag.

Table 4-23 shows the host interface default settings for the Audio Channel Status block. The audio de-embedder automatically generates the CRC word.

Table 4-23: Audio Channel Status Information Registers

Name	Description	Default
ACSR[7-0]	Audio channel status block byte 0 set. Used when ACS_REGEN is set HIGH	85h
ACSR[15-8]	Audio channel status block byte 1 set. Used when ACS_REGEN is set HIGH	08h
ACSR[23-16]	Audio channel status block byte 2 set. Used when ACS_REGEN is set HIGH	28h (SD) 2Ch (HD)
ACSR[31-24]: ACSR[183-176]	Audio channel status block data for bytes 3 to 22. Used when ACS_REGEN is set HIGH	00h
ACS_REGEN	Audio channel status regenerate	0
ACS_APPLY	Apply new ACSR data	0
ACS_APPLY_W AIT[A:D]	Waiting to apply new ACSR data	0
ACS[7-0]: ACS[183-176]	Audio channel status block data for bytes 0 to 22	00h: 00h

Table 4-24: Audio Channel Status Block for Regenerate Mode Default Settings

Name	Byte	Bit	Default	Mode
PRO	0	0	1b	Professional use of channel status block
Emphasis	0	2-4	100b	100b None. Rec. manual override disabled
Sample Frequency	0	6-7	01b	48kHz. Manual override or auto disabled
Channel Mode	1	0-3	0001b	Two channels. Manual override disabled
AUX	2	0-2	000b	SD Modes: Maximum audio word length is 20 bits
			001b	HD Mode: Maximum audio word length is 24 bits
Source Word Length	2	3-5	101b	Maximum word length (based on AUX setting). 24-bit for HD Mode; 20-bit for SD Modes
All other bits set to zero				

4.18.3.7 Audio Mute

When the MUTE bits in the host interface are set HIGH, the audio outputs are muted (all audio sample bits are set to zero). To set all the audio output channels to mute, set the host interface MUTE_ALL bit HIGH.

Table 4-25: Audio Mute Control Bits

Name	Description	Default
MUTE_ALL	Ch1-8 audio mute enable (1: Enabled)	0
MUTE8	Ch8 audio mute enable (1: Enabled)	0
MUTE7	Ch7 audio mute enable (1: Enabled)	0
MUTE6	Ch6 audio mute enable (1: Enabled)	0
MUTE5	Ch5 audio mute enable (1: Enabled)	0
MUTE4	Ch4 audio mute enable (1: Enabled)	0
MUTE3	Ch3 audio mute enable (1: Enabled)	0
MUTE2	Ch2 audio mute enable (1: Enabled)	0
MUTE1	Ch1 audio mute enable (1: Enabled)	0

Mute On Loss Of Lock

When the GS1671 loses lock (LOCKED signal is LOW), the audio de-embedder sets all audio outputs LOW (no audio formatting is performed). The ACLK, WCLK and AMCLK outputs are also forced LOW.

4.18.4 Error Reporting

4.18.4.1 Data Block Number Error

When the 1-255 count sequence in the Data Block Number (DBN) word of Group A audio data packets is discontinuous, the DBNA_ERR bit in the host interface (DBN_ERR register for SD, ACS_DET register for HD) is set HIGH. When the 1-255 count sequence in the DBN word of Group B audio data packets is discontinuous, the DBNB_ERR bit in the host interface (DBN_ERR register for SD, ACS_DET register for HD) register is set HIGH.

4.18.4.2 ECC Error

The GS1671 monitors the ECC error status of the two selected audio groups, as described in [Section 4.18.2.6 on page 70](#).

The ECC[N]_ERROR flags also have associated SD_AUDIO_ERROR_MASK and HD_AUDIO_ERROR_MASK register flags for configuration of error reporting in the Receiver. The ECC[N]_ERROR flags remain set until read via the host interface.

4.19 GSPI - HOST Interface

The GSPI, or Gennum Serial Peripheral Interface, is a 4-wire interface provided to allow the system to access additional status and control information through configuration registers in the GS1671.

The GSPI is comprised of a Serial Data Input signal (SDIN), Serial Data Output signal (SDOUT), an active low Chip Select (\overline{CS}), and a Burst Clock (SCLK).

Because these pins are shared with the JTAG interface port, an additional control signal pin JTAG/ \overline{HOST} is provided.

When JTAG/ \overline{HOST} is LOW, the GSPI interface is enabled. When JTAG/ \overline{HOST} is HIGH, the JTAG interface is enabled.

When operating in GSPI mode, the SCLK, SDIN, and \overline{CS} signals must be provided by the system. The SDO pin is a non-clocked loop-through of SDIN and may be connected to the SDIN of another device, allowing multiple devices to be connected to the GSPI chain. See Section 4.19.2 for details. The interface is illustrated in the Figure 4-38 below.

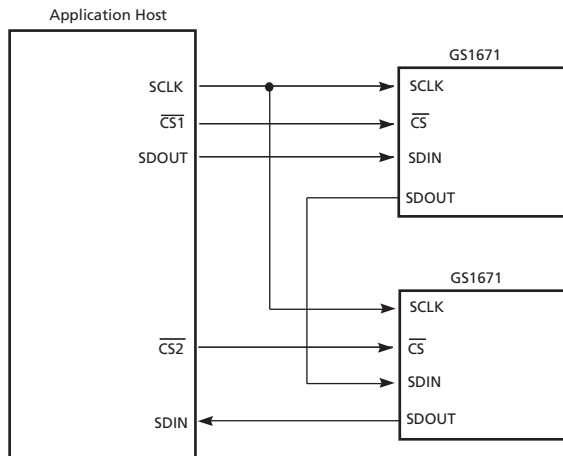

Figure 4-38: GSPI Application Interface Connection

All read or write access to the GS1671 is initiated and terminated by the system host processor. Each access always begins with a Command/Address Word, followed by a data write to, or data read from, the GS1671.

4.19.1 Command Word Description

The Command Word consists of a 16-bit word transmitted MSB first and contains a read/write bit, an Auto-Increment bit and a 12-bit address.

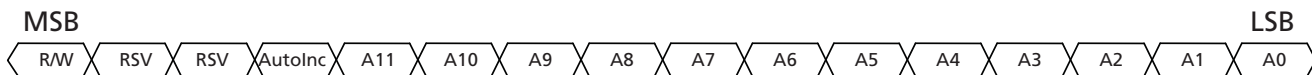

Figure 4-39: Command Word Format

Command Words are clocked into the GS1671 on the rising edge of the Serial Clock SCLK, which operates in a burst fashion. The chip select (\overline{CS}) signal must be set low a

minimum of 1.5ns (t_0 in Figure 4-41) before the first clock edge to ensure proper operation.

When the Auto-Increment bit is set LOW, each Command Word must be followed by only one Data Word to ensure proper operation.

If the Auto-Increment bit is set HIGH, the following Data Word is written into the address specified in the Command Word, and subsequent Data Words are written into incremental addresses from the first Data Word. This facilitates multiple address writes without sending a Command Word for each Data Word.

NOTE: The RSV bits in the GSPI command word can be set to zero as placeholder, though these bits are not used.

4.19.2 Data Read or Write Access

During a read sequence (Command Word R/W bit set HIGH) serial data is transmitted or received MSB first, synchronous with the rising edge of the serial clock SCLK. The Chip Select (\overline{CS}) signal must be set low a minimum of 1.5ns (t_0 in Figure 4-41) before the first clock edge to ensure proper operation. The first bit (MSB) of the Serial Output (SDOUT) is available (t_5 in Figure 4-42) following the last falling SCLK edge of the read Command Word, the remaining bits are clocked out on the negative edges of SCLK.

NOTE: When several devices are connected to the GSPI chain, only one \overline{CS} may be asserted during a read sequence.

During a write sequence (Command Word R/W bit set LOW), a wait state of 37.1ns (t_4 in Figure 4-41) is required between the Command Word and the following Data Word. This wait state must also be maintained between successive Command Word/Data Word write sequences. When Auto Increment mode is selected (AutoInc = 1), the wait state must be maintained between successive Data Words after the initial Command Word/Data Word sequence.

During the write sequence, all Command and following Data Words input at the SDIN pin are output at the SDOUT pin unchanged. When several devices are connected to the GSPI chain, data can be written simultaneously to all the devices which have \overline{CS} set LOW.

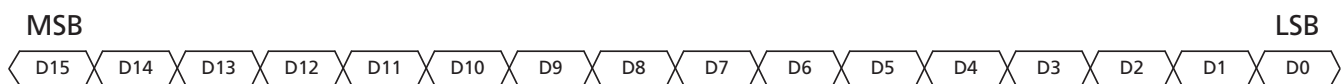

Figure 4-40: Data Word Format

4.19.3 GSPI Timing

Write and Read Mode timing for the GSPI interface;

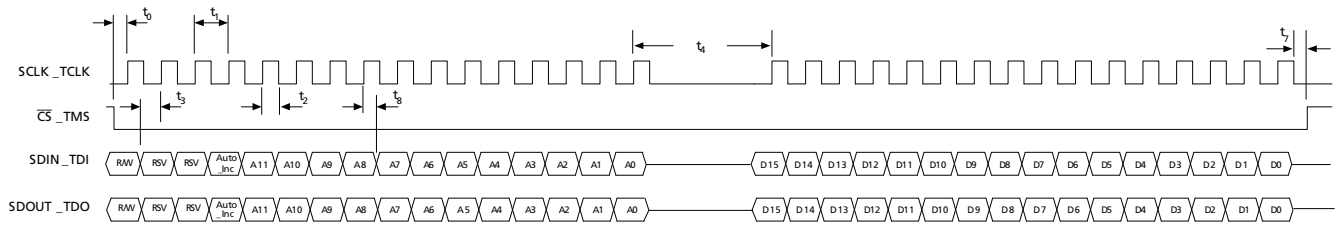

Figure 4-41: Write Mode

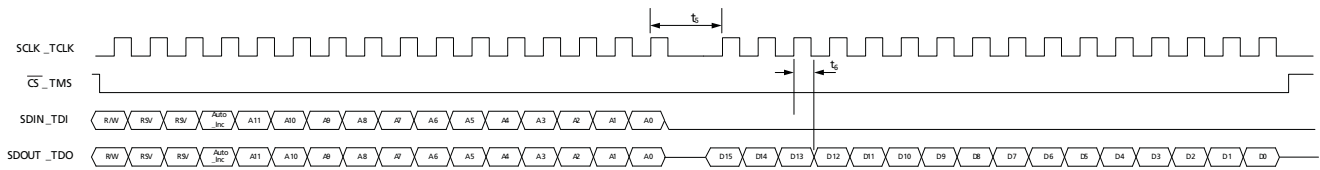

Figure 4-42: Read Mode

SDIN_TDI to SDOUT_TDO combinational path for daisy chain connection of multiple GS1671.

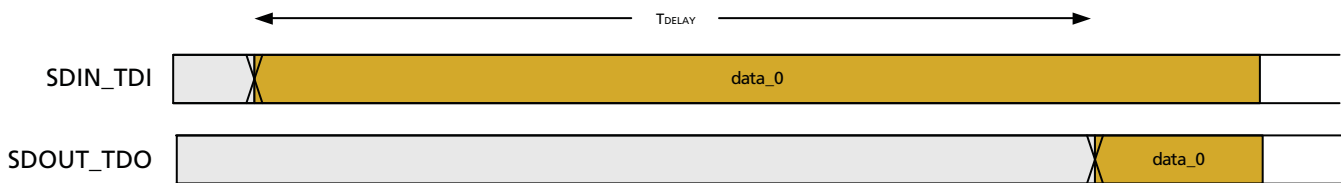

Figure 4-43: GSPI Time Delay

Table 4-26: GSPI Time Delay

Parameter	Symbol	Conditions	Min	Typ	Max	Units
Delay time	t_{DELAY}	50% levels; 1.8V operation	–	–	13.1	ns
Delay time	t_{DELAY}	50% levels; 3.3V operation	–	–	9.7	ns

Table 4-27: GSPI Timing Parameters (50% levels; 3.3V or 1.8V operation)

Parameter	Symbol	Min	Typ	Max	Units	
\overline{CS} low before SCLK rising edge	t_0	1.5	–	–	ns	
SCLK period	t_1	16.67	–	–	ns	
SCLK duty cycle	t_2	40	50	60	%	
Input data setup time	t_3	1.5	–	–	ns	
Time between end of Command Word (or data in Auto-Increment mode) and the first SCLK of the following Data Word – write cycle	t_4	PCLK (MHz)	ns	–	–	ns
		unlocked	100			
		27.0	37.1			
		74.25	13.5			
		148.5	6.7			
Time between end of Command Word (or data in Auto-Increment mode) and the first SCLK of the following Data Word – read cycle.	t_5	PCLK (MHz)	ns	–	–	ns
		unlocked	–			
		27.0	148.4			
		74.25	53.9			
		148.5	27			
Time between end of Command Word (or data in Auto-Increment mode) and the first SCLK of the following Data Word – read cycle - ANC FIFO Read	t_5	222.6	–	–	ns	
Output hold time (15pF load)	t_6	1.5	–	–	ns	
\overline{CS} high after last SCLK rising edge	t_7	PCLK (MHz)	ns	–	–	ns
		unlocked	445			
		27.0	37.1			
		74.25	13.5			
		148.5	6.7			
Input data hold time	t_8	1.5	–	–	ns	

This timing must be satisfied across all ambient temperature and power supply operating conditions, as described in the [Electrical Characteristics on page 16](#).

4.20 Host Interface Register Maps

NOTE: The GS1671 only accepts write/read commands to/from the Audio Register Maps when the audio core is locked to the incoming video data rate. The Video Register Map is always active, whether valid serial input data is present or not.

4.20.1 Video Core Registers

Table 4-28: Video Core Configuration and Status Registers

Address	Register Name	Bit Name	Bit	Description	R/W	Default
000h	IOPROC_1	RSVD	15	Reserved.	R	0
		TRS_WORD_REMAP_DS1_DISABLE	14	Disables 8-bit TRS word remapping for HD and SD inputs.	R/W	0
		RSVD	13	Reserved.	R/W	0
		EDH_FLAG_UPDATE_MASK	12	Disables updating of EDH error flags.	R/W	0
		EDH_CRC_INS_MASK	11	Disables EDH_CRC error correction and insertion.	R/W	0
		H_CONFIG	10	Selects the H blanking indication: 0: Active line blanking - the H output is HIGH for all the horizontal blanking period, including the EAV and SAV TRS words. 1: TRS based blanking - the H output is set HIGH for the entire horizontal blanking period as indicated by the H bit in the received TRS signals. This signal is only valid when TIM_861 is set to '0' (via pin or host interface).	R/W	0
		ANC_DATA_EXT_MASK	9	Disables ancillary data extraction FIFO.	R/W	0
		AUD_EXT_MASK	8	Disables audio extraction block.	R/W	0
		TIM_861_PIN_DISABLE	7	Disable TIM_861 pin control when set to '1', and use TIMING_861 bit instead.	R/W	0
		TIMING_861	6	Selects the output timing reference format: 0 = Digital FVH timing output; 1 = CEA-861 timing output.	R/W	0
		RSVD	5	Reserved.	R/W	0
		ILLEGAL_WORD_REMAP_DS1_MASK	4	Disables illegal word remapping for HD and SD inputs.	R/W	0

Table 4-28: Video Core Configuration and Status Registers (Continued)

Address	Register Name	Bit Name	Bit	Description	R/W	Default
000h	IOPROC_1	ANC_CHECKSUM_INSERTION_DS1_MASK	3	Disables insertion of ancillary data checksums for HD and SD inputs.	R/W	0
		CRC_INS_DS1_MASK	2	Disables insertion of HD CRC words for HD inputs.	R/W	0
		LNUM_INS_DS1_MASK	1	Disables insertion of line numbers for HD inputs.	R/W	0
		TRS_INS_DS1_MASK	0	Disables insertion of TRS words for HD and SD inputs.	R/W	0
001h	IOPROC_2	RSVD	15-0	Reserved.	R/W	N/A
002h	ERROR_STAT_1	RSVD	15-11	Reserved.	ROCW	0
		VD_STD_ERR_DS1	10	Video Standard Error indication for HD and SD inputs.	ROCW	0
		FF_CRC_ERR	9	EDH Full Frame CRC error indication.	ROCW	0
		AP_CRC_ERR	8	EDH Active Picture CRC error indication.	ROCW	0
		RSVD	7	Reserved.	ROCW	0
		CCS_ERR_DS1	6	Chroma ancillary data checksum error indication for HD and SD inputs.	ROCW	0
		YCS_ERR_DS1	5	Luma ancillary data checksum error indication for HD and SD inputs.	ROCW	0
		CCRC_ERR_DS1	4	Chroma CRC error indication for HD inputs.	ROCW	0
		YCRC_ERR_DS1	3	Luma CRC error indication for HD inputs.	ROCW	0
		LNUM_ERR_DS1	2	Line number error indication for HD inputs.	ROCW	0
		SAV_ERR_DS1	1	SAV error indication for HD and SD inputs.	ROCW	0
EAV_ERR_DS1	0	EAV error indication for HD and SD inputs.	ROCW	0		
003h	RSVD	RSVD	15-0	Reserved.	ROCW	N/A

Table 4-28: Video Core Configuration and Status Registers (Continued)

Address	Register Name	Bit Name	Bit	Description	R/W	Default
004h	EDH_FLAG_IN	EDH_DETECT	15	Embedded EDH packet detected.	R	0
		ANC_UES_IN	14	Ancillary data – unknown error status flag.	R	0
		ANC_IDA_IN	13	Ancillary data – internal error detected already flag.	R	0
		ANC_IDH_IN	12	Ancillary data – internal error detected here flag	R	0
		ANC_EDA_IN	11	Ancillary data – error detected already flag.	R	0
		ANC_EDH_IN	10	Ancillary data – error detected here flag.	R	0
		FF_UES_IN	9	EDH Full Field – unknown error status flag.	R	0
		FF_IDA_IN	8	EDH Full Field – internal error detected already flag.	R	0
		FF_IDH_IN	7	EDH Full Field – internal error detected here flag.	R	0
		FF_EDA_IN	6	EDH Full Field – error detected already flag.	R	0
		FF_EDH_IN	5	EDH Full Field – error detected here flag.	R	0
		AP_UES_IN	4	EDH Active Picture – unknown error status flag.	R	0
		AP_IDA_IN	3	EDH Active Picture – internal error detected already flag.	R	0
		AP_IDH_IN	2	EDH Active Picture – internal error detected here flag.	R	0
		AP_EDA_IN	1	EDH Active Picture – error detected already flag.	R	0
		AP_EDH_IN	0	EDH Active Picture – error detected here flag.	R	0

Table 4-28: Video Core Configuration and Status Registers (Continued)

Address	Register Name	Bit Name	Bit	Description	R/W	Default
005h	EDH_FLAG_OUT	RSVD	15	Reserved.	R	0
		ANC_UES	14	Ancillary data – Unknown Error Status flag.	R	1
		ANC_IDA	13	Ancillary data – Internal error Detected Already flag.	R	0
		ANC_IDH	12	Ancillary data – Internal error Detected Here flag.	R	0
		ANC_EDA	11	Ancillary data – Error Detected Already flag.	R	0
		ANC_EDH	10	Ancillary data – Error Detected Here flag.	R	0
		FF_UES	9	EDH Full Field – Unknown Error Status flag.	R	1
		FF_IDA	8	EDH Full Field – Internal error Detected Already flag.	R	0
		FF_IDH	7	EDH Full Field – Internal error Detected Here flag.	R	0
		FF_EDA	6	EDH Full Field – Error Detected Already flag.	R	0
		FF_EDH	5	EDH Full Field – Error Detected Here flag.	R	0
		AP_UES	4	EDH Active Picture – Unknown Error Status flag.	R	1
		AP_IDA	3	EDH Active Picture – Internal error Detected Already flag.	R	0
		AP_IDH	2	EDH Active Picture – Internal error Detected Here flag.	R	0
		AP_EDA	1	EDH Active Picture – Error Detected Already flag.	R	0
		AP_EDH	0	EDH Active Picture – Error Detected Here flag.	R	0
006h	DATA_FORMAT_DS1	FF_CRC_V	15	EDH Full Field CRC Validity bit.	R	0
		AP_CRC_V	14	EDH Active Picture CRC Validity bit.	R	0
		VD_STD_DS1	13-8	Detected Video Standard for HD and SD inputs.	R	29
		CDATA_FORMAT_DS1	7-4	Data format as indicated in Chroma channel for HD and SD inputs.	R	15
		YDATA_FORMAT_DS1	3-0	Data format as indicated in Luma channel for HD and SD inputs.	R	15
007h	RSVD	RSVD	15-0	Reserved.	R	N/A

Table 4-28: Video Core Configuration and Status Registers (Continued)

Address	Register Name	Bit Name	Bit	Description	R/W	Default
008h	IO_CONFIG	RSVD	15	Reserved.	RW	0
		STAT2_CONFIG	14-10	Configure STAT2 output pin: 00000: H Blanking when TIM_861 = 0; HSYNC when TIM_861 = 1 00001: V Blanking when TIM_861 = 0; VSYNC when TIM_861 = 1 00010: F bit when TIM_861 = 0; Data Enable (DE) when TIM_861 = 1 00011: LOCKED 00100: Y/1ANC: ANC indication (SD), Luma ANC indication (HD) 00101: C/2ANC: Chroma ANC indication (HD) 00110: Data Error 00111: Video Error 01000: Audio Error 01001: EDH Detected 01010: Carrier Detect 01011: RATE_DET 01100 - 11111: Reserved	RW	2
		STAT1_CONFIG	9-5	Configure STAT1 output pin. (Refer to above for decoding)	RW	1
		STAT0_CONFIG	4-0	Configure STAT0 output pin. (Refer to above for decoding)	RW	0
009h	IO_CONFIG2	RSVD	15	Reserved.	RW	0
		STAT5_CONFIG	14-10	Configure STAT5 output pin. (Refer to above for decoding)	RW	6
		STAT4_CONFIG	9-5	Configure STAT4 output pin. (Refer to above for decoding)	RW	4
		STAT3_CONFIG	4-0	Configure STAT3 output pin. (Refer to above for decoding)	RW	3
00Ah	ANC_CONTROL	RSVD	15-4	Reserved.	RW	0
		ANC_DATA_SWITCH	3	Switches between FIFO memories.	RW	0
		ANC_DATA_DEL	2	Remove Ancillary Data from output video stream, set to Luma and Chroma blanking values.	RW	0
		HD_ANC_Y1_C2	1	Extract Ancillary data from Luma and Chroma channels (HD inputs).	RW	0
		HD_ANC_C2	0	Extract Ancillary data only from Chroma channel (HD inputs).	RW	0
00Bh	ANC_LINE_A	RSVD	15-11	Reserved.	R/W	0
		ANC_LINE_A	10-0	Video Line to extract Ancillary data from.	R/W	0
00Ch	ANC_LINE_B	RSVD	15-11	Reserved.	R/W	0
		ANC_LINE_B	10-0	Second video Line to extract Ancillary data from.	R/W	0

Table 4-28: Video Core Configuration and Status Registers (Continued)

Address	Register Name	Bit Name	Bit	Description	R/W	Default
00Dh - 00Eh	RSVD	RSVD	15-0	Reserved.	R	0
00Fh	ANC_TYPE_1_AP 1	ANC_TYPE1_DS1	15-0	Programmable DID/SDID pair #1 to extract from HD and SD input formats ([15:8] = DID, [7:0] =SDID).	R/W	0
010h	ANC_TYPE_2_AP 1	ANC_TYPE2_DS1	15-0	Programmable DID/SDID pair #2 to extract from HD and SD input formats ([15:8] = DID, [7:0] =SDID).	R/W	0
011h	ANC_TYPE_3 _AP1	ANC_TYPE3_DS1	15-0	Programmable DID/SDID pair #3 to extract from HD and SD input formats ([15:8] = DID, [7:0] =SDID).	R/W	0
012h	ANC_TYPE_4 _AP1	ANC_TYPE4_DS1	15-0	Programmable DID/SDID pair #4 to extract from HD and SD input formats ([15:8] = DID, [7:0] =SDID).	R/W	0
013h	ANC_TYPE_5 _AP1	ANC_TYPE5_DS1	15-0	Programmable DID/SDID pair #5 to extract from HD and SD input formats ([15:8] = DID, [7:0] =SDID).	R/W	0
014h - 018h	RSVD	RSVD	15-0	Reserved.	R/W	N/A
019h	VIDEO_FORMAT _352_A_1	VIDEO_FORMAT_2_DS1	15-8	SMPTE 352M embedded packet – byte 2.	R	0
		VIDEO_FORMAT_1_DS1	7-0	SMPTE 352M embedded packet – byte 1: [7]: Version identifier [6:0]: Video Payload Identifier.	R	0
01Ah	VIDEO_FORMAT _352_B_1	VIDEO_FORMAT_4_DS1	15-8	SMPTE 352M embedded packet – byte 4.	R	0
		VIDEO_FORMAT_3_DS1	7-0	SMPTE 352M embedded packet – byte 3.	R	0
01Bh - 01Eh	RSVD	RSVD	15-0	Reserved.	R/W	N/A
01Fh	RASTER_STRUC_ 1	RSVD	15-14	Reserved.	R	0
		WORDS_PER_ACTLINE	13-0	Words Per Active Line.	R	0
020h	RASTER_STRUC_ 2	RSVD	15-14	Reserved.	R	0
		WORDS_PER_LINE	13-0	Total Words Per Line.	R	0
021h	RASTER_STRUC_ 3	RSVD	15-11	Reserved.	R	0
		LINES_PER_FRAME	10-0	Total Lines Per Frame.	R	0

Table 4-28: Video Core Configuration and Status Registers (Continued)

Address	Register Name	Bit Name	Bit	Description	R/W	Default	
022h	RASTER_STRUC_4	RATE_SEL_READBACK	15-14	Read back detected data rate: 0 = HD, 1,3=SD, 2=Reserved	R	0	
		M	13	Specifies detected M value 0: 1.000 1: 1.001	R	0	
		<p>Note: In certain systems, due to greater ppm offset in the crystal, the 'M' bit may not assert properly. In such cases, bits 3:0 in Register 06Fh can be increased to a maximum value of 4.</p>					
		STD_LOCK	12	Video standard lock.	R	0	
		INT_PROG	11	Interlaced or progressive.	R	0	
023h	FLYWHEEL_STATUS	ACTLINE_PER_FIELD	10-0	Active lines per frame.	R	0	
		RSVD	15-2	Reserved.	R	0	
		V_LOCK_DS1	1	Indicates that the timing signal generator is locked to vertical timing (HD and SD inputs).	R	0	
024h	RATE_SEL	H_LOCK_DS1	0	Indicates that the timing signal generator is locked to horizontal timing (HD and SD inputs).	R	0	
		RSVD	15-3	Reserved.	R	0	
		AUTO/MAN	2	Detect data rate automatically (1) or program manually (0).	R/W	1	
025h	TIM_861_FORMAT	RATE_SEL_TOP	1-0	Programmable rate select in manual mode: 0 = HD, 1,3=SD, 2=Reserved	R/W	0	
		RSVD	15-7	Reserved.	R	0	
		FORMAT_ERR	6	Indicates standard is not recognized for CEA 861 conversion.	R	1	
026h	TIM_861_CFG	FORMAT_ID_861	5-0	CEA-861 format ID of input video stream. Refer to Table 4-9 .	R	0	
		RSVD	15-3	Reserved.	R	0	
		VSYNC_INVERT	2	Invert output VSYNC pulse.	R/W	0	
		HSYNC_INVERT	1	Invert output HSYNC pulse.	R/W	0	
027h - 036h	RSVD	TRS_861	0	Sets the timing reference outputs to DFP timing mode when set to '1'. By default, the timing reference outputs follow CEA-861 timing mode. Only valid when TIM_861 is set to '1'.	R/W	0	
		RSVD	–	Reserved.	R	0	

Table 4-28: Video Core Configuration and Status Registers (Continued)

Address	Register Name	Bit Name	Bit	Description	R/W	Default
037h	ERROR_MASK_1	RSVD	15-11	Reserved.	R	0
		ERROR_MASK_1	10-0	Error mask for global error vector (HD, SD): bit[0]: EAV_ERR_DS1 mask bit[1]: SAV_ERR_DS1 mask bit[2]: LNUM_ERR_DS1 mask bit[3]: YCRC_ERR_DS1 mask bit[4]: CCRC_ERR_DS1 mask bit[5]: YCS_ERR_DS1 mask bit[6]: CCS_ERR_DS1 mask bit[7]: Reserved bit[8]: AP_CRC_ERR mask bit[9]: FF_CRC_ERR mask bit[10]: VD_STD_ERR_DS1 mask	R/W	0
038h	ERROR_MASK_2	RSVD	15-0	Reserved.	R	0
039h	ACGEN_CTRL	RSVD	15-5	Reserved.	R	0
		SCLK_INV	4	Invert polarity of output serial audio clock.	R/W	0
		AMCLK_INV	3	Invert polarity of output audio master clock.	R/W	0
		RSVD	2	Reserved.	R/W	0
		AMCLK_SEL	1-0	Audio Master Clock Select. 0: 128 fs 1: 256 fs 2: 512 fs	R/W	0
03Ah -6Bh	RSVD	RSVD	15-0	Reserved.	R	0
06Ch	CLK_GEN	RSVD	15-5	Reserved.	R/W	0
		DEL_LINE_OFFSET	4-0	Controls the offset for the delay line.	R/W	0

Table 4-28: Video Core Configuration and Status Registers (Continued)

Address	Register Name	Bit Name	Bit	Description	R/W	Default
06Dh	IO_DRIVE _STRENGTH	RSVD	15-6	Reserved.	R/W	0
		IO_DS_CTRL_DOUT_MSB	5-4	Drive strength adjustment for DOUT[19:10] outputs and PCLK output: 00: 4mA; 01: 8mA; 10: 10mA(1.8V), 12mA(3.3V); 11: 12mA(1.8V), 16mA(3.3V)	R/W	2
		IO_DS_CTRL_STAT	3-2	Drive strength adjustment for STAT[5:0] outputs: 00: 4mA; 01: 6mA; 10: 8mA(1.8V), 10mA(3.3V); 11: 10mA(1.8V), 12mA(3.3V)	R/W	2
		IO_DS_CTRL_DOUT_LSB	1-0	Drive strength adjustment for DOUT[9:0] outputs: 00: 4mA; 01: 6mA; 10: 8mA(1.8V), 10mA(3.3V); 11: 10mA(1.8V), 12mA(3.3V)	R/W	3
06Eh - 072h	RSVD	RSVD	–	Reserved.	R/W	0
073h	EQ_BYPASS	RSVD	15-10	Reserved.	R/W	0
		EQ_BYPASS	9	0: non-bypass EQ 1: bypass EQ	R/W	0
		RSVD	8-0	Reserved.	R/W	0
074h -085h	RSVD	RSVD	15-0	Reserved.	R/W	0

4.20.2 SD Audio Core Registers

NOTE: The GS1671 only accepts write/read commands to/from the SD Audio Register Map when the audio core is locked to the incoming SD video format.

Table 4-29: SD Audio Core Configuration and Status Registers

Address	Register Name	Bit Name	Bit	Description	R/W	Default
400h	CFG_AUD	RSVD	15-14	Reserved.	R/W	0
		ALL_DEL	13	Selects deletion of all audio data and all audio control packets. 0: Do not delete existing audio packets 1: Delete existing audio packets	R/W	0
		MUTE_ALL	12	Mute all output channels. 0: Normal 1: Muted	R/W	0
		ACS_USE_SECOND	11	Extract Audio Channel Status from second channel pair.	R/W	0
		CLEAR_AUDIO	10	Clears all audio FIFO buffers and puts them in start-up state.	R/W	0
		OS_SEL	9-8	Specifies the audio FIFO buffer size. 00: 36 samples deep, 26 sample start-up count 01: 22 samples deep, 12 sample start-up count 10: 16 samples deep, 6 sample start-up count 11: Reserved	R/W	0
		LSB_FIRSTD	7	Causes the channel 7 and 8 output format to use LSB first. 0: MSB first 1: LSB first	R/W	0
		LSB_FIRSTC	6	Causes the channel 5 and 6 output format to use LSB first. 0: MSB first 1: LSB first	R/W	0
		LSB_FIRSTB	5	Causes the channel 3 and 4 output format to use LSB first. 0: MSB first 1: LSB first	R/W	0
LSB_FIRSTA	4	Causes the channel 1 and 2 output format to use LSB first. 0: MSB first 1: LSB first	R/W	0		

Table 4-29: SD Audio Core Configuration and Status Registers (Continued)

Address	Register Name	Bit Name	Bit	Description	R/W	Default
400h	CFG_AUD	IDB	3-2	Specifies the Secondary audio group to extract. 00: Audio group #1 01: Audio group #2 10: Audio group #3 11: Audio group #4 Note: Should IDA and IDB be set to the same value, they automatically revert to their default values.	R/W	1
		IDA	1-0	Specifies the Primary audio group to extract. 00: Audio group #1 01: Audio group #2 10: Audio group #3 11: Audio group #4 Note: Should IDA and IDB be set to the same value, they automatically revert to their default values.	R/W	0
401h	DBN_ERR	EXT_DET3_4B	15	Set when Secondary group channels 3 and 4 have extended data. Write '1' to clear.	ROCW	0
		EXT_DET1_2B	14	Set when Secondary group channels 1 and 2 have extended data. Write '1' to clear.	ROCW	0
		EXT_DET3_4A	13	Set when Primary group channels 3 and 4 have extended data. Write '1' to clear.	ROCW	0
		EXT_DET1_2A	12	Set when Primary group channels 1 and 2 have extended data. Write '1' to clear.	ROCW	0
		CTL_DBNB_ERR	11	Set when Secondary group control packet Data Block Number sequence is discontinuous. Write '1' to clear.	ROCW	0
		CTL_DBNA_ERR	10	Set when Primary group control packet Data Block Number sequence is discontinuous. Write '1' to clear.	ROCW	0
		EXT_DBNB_ERR	9	Set when Secondary group extended data packet Data Block Number sequence is discontinuous. Write '1' to clear.	ROCW	0
		EXT_DBNA_ERR	8	Set when Primary group extended data packet Data Block Number sequence is discontinuous. Write '1' to clear.	ROCW	0

Table 4-29: SD Audio Core Configuration and Status Registers (Continued)

Address	Register Name	Bit Name	Bit	Description	R/W	Default
401h	DBN_ERR	SAMP_DBNB_ERR	7	Set when Secondary group data packet Data Block Number sequence is discontinuous. Write '1' to clear.	ROCW	0
		SAMP_DBNA_ERR	6	Set when Primary group data packet Data Block Number sequence is discontinuous. Write '1' to clear.	ROCW	0
		CTRB_DET	5	Set when Secondary group audio control packet is detected. Write '1' to clear.	ROCW	0
		CTRA_DET	4	Set when Primary group audio control packet is detected. Write '1' to clear.	ROCW	0
		ACS_DET3_4B	3	Secondary group audio status detected for channels 3 and 4. Write '1' to clear.	ROCW	0
		ACS_DET1_2B	2	Secondary group audio status detected for channels 1 and 2. Write '1' to clear.	ROCW	0
		ACS_DET3_4A	1	Primary group audio status detected for channels 3 and 4. Write '1' to clear.	ROCW	0
		ACS_DET1_2A	0	Primary group audio status detected for channels 1 and 2. Write '1' to clear.	ROCW	0
402h	REGEN	RSVD	15-2	Reserved.	R/W	0
		ACS_APPLY	1	Cause channel status data in ACSR[183:0] to be transferred to the channel status replacement mechanism. The transfer does not occur until the next status boundary.	R/W	0
		ACS_REGEN	0	Specifies that Audio Channel Status of all channels should be replaced with ACSR[183:0] field. 0: Do not replace Channel Status 1: Replace Channel Status of all channels	R/W	0

Table 4-29: SD Audio Core Configuration and Status Registers (Continued)

Address	Register Name	Bit Name	Bit	Description	R/W	Default
403h	AUD_DET	IDB_READBACK	15-14	Actual value of IDB in the hardware.	R	1
		IDA_READBACK	13-12	Actual value of IDA in the hardware.	R	0
		XDPG4_DET	11	Set while embedded Group 4 audio extended packets are detected.	R	0
		XDPG3_DET	10	Set while embedded Group 3 audio extended packets are detected.	R	0
		XDPG2_DET	9	Set while embedded Group 2 audio extended packets are detected.	R	0
		XDPG1_DET	8	Set while embedded Group 1 audio extended packets are detected.	R	0
		ADPG4_DET	7	Set while Group 4 audio data packets are detected.	R	0
		ADPG3_DET	6	Set while Group 3 audio data packets are detected.	R	0
		ADPG2_DET	5	Set while Group 2 audio data packets are detected.	R	0
		ADPG1_DET	4	Set while Group 1 audio data packets are detected.	R	0
		ACS_APPLY_WAITD	3	Set while output channels 7 and 8 are waiting for a status boundary to apply the ACSR[183:0] data.	R	0
		ACS_APPLY_WAITC	2	Set while output channels 5 and 6 are waiting for a status boundary to apply the ACSR[183:0] data.	R	0
		ACS_APPLY_WAITB	1	Set while output channels 3 and 4 are waiting for a status boundary to apply the ACSR[183:0] data.	R	0
ACS_APPLY_WAITA	0	Set while output channels 1 and 2 are waiting for a status boundary to apply the ACSR[183:0] data.	R	0		
404h	CSUM_ERR_DET	RSVD	15-1	Reserved.	R/W	0
		CSUM_ERROR	0	Embedded packet checksum error detected. Write '1' to clear.	ROCW	0
405h	CH_MUTE	RSVD	15-8	Reserved.	R/W	0
		MUTE	7-0	Mute output channels 8..1 Where bits 7:0 = channel 8:1 1: Mute 0: Normal	R/W	0

Table 4-29: SD Audio Core Configuration and Status Registers (Continued)

Address	Register Name	Bit Name	Bit	Description	R/W	Default
406h	CH_VALID	RSVD	15-8	Reserved.	R/W	0
		CH4_VALIDDB	7	Secondary group channel 4 sample validity flag.	R	0
		CH3_VALIDDB	6	Secondary group channel 3 sample validity flag.	R	0
		CH2_VALIDDB	5	Secondary group channel 2 sample validity flag.	R	0
		CH1_VALIDDB	4	Secondary group channel 1 sample validity flag.	R	0
		CH4_VALIDA	3	Primary group channel 4 sample validity flag.	R	0
		CH3_VALIDA	2	Primary group channel 3 sample validity flag.	R	0
		CH2_VALIDA	1	Primary group channel 2 sample validity flag.	R	0
		CH1_VALIDA	0	Primary group channel 1 sample validity flag.	R	0
407h	SD_AUDIO_ERR OR_MASK	RSVD	15	Reserved.	R/W	0
		EN_NOT_LOCKED	14	Asserts <i>interrupt</i> when LOCKED signal is not asserted.	R/W	0
		EN_NO_VIDEO	13	Asserts <i>interrupt</i> when video format is unknown.	R/W	0
		EN_CSUM_ERROR	12	Asserts <i>interrupt</i> when checksum error is detected.	R/W	0
		EN_ACS_DET3_4B	11	Asserts <i>interrupt</i> when EN_ACS_DET3_4B flag is set.	R/W	0
		EN_ACS_DET1_2B	10	Asserts <i>interrupt</i> when EN_ACS_DET1_2B flag is set.	R/W	0
		EN_ACS_DET3_4A	9	Asserts <i>interrupt</i> when EN_ACS_DET3_4A flag is set.	R/W	0
		EN_ACS_DET1_2A	8	Asserts <i>interrupt</i> when EN_ACS_DET1_2A flag is set.	R/W	0
		EN_CTRB_DET	7	Asserts <i>interrupt</i> when EN_CTRB_DET flag is set.	R/W	0
		EN_CTRA_DET	6	Asserts <i>interrupt</i> when EN_CTRA_DET flag is set.	R/W	0
		EN_DBNB_ERR	5	Asserts <i>interrupt</i> when EN_DBNB_ERR flag is set.	R/W	0
		EN_DBNA_ERR	4	Asserts <i>interrupt</i> when EN_DBNA_ERR flag is set.	R/W	0

Table 4-29: SD Audio Core Configuration and Status Registers (Continued)

Address	Register Name	Bit Name	Bit	Description	R/W	Default
407h	SD_AUDIO_ERR_OR_MASK	EN_ADPG4_DET	3	Asserts <i>interrupt</i> when the ADPG4_DET flag is set.	R/W	0
		EN_ADPG3_DET	2	Asserts <i>interrupt</i> when the ADPG3_DET flag is set.	R/W	0
		EN_ADPG2_DET	1	Asserts <i>interrupt</i> when the ADPG2_DET flag is set.	R/W	0
		EN_ADPG1_DET	0	Asserts <i>interrupt</i> when the ADPG1_DET flag is set.	R/W	0
408h	CFG_OUTPUT	ASWLD	15-14	Output channels 7 and 8 word length. 00: 24 bits 01: 20 bits 10: 16 bits 11: Automatic 20-bit or 24-bit	R/W	3
		ASWLC	13-12	Output channels 5 and 6 word length. (See above for decoding)	R/W	3
		ASWLB	11-10	Output channels 3 and 4 word length. (See above for decoding)	R/W	3
		ASWLA	9-8	Output channels 1 and 2 word length. (See above for decoding)	R/W	3
		AMD	7-6	Output channels 7 and 8 format selector. 00: AES/EBU audio output 01: Serial audio output: Left justified; MSB first 10: Serial audio output: Right justified; MSB first 11: I ² S serial audio output	R/W	3
		AMC	5-4	Output channels 5 and 6 format selector. (See above for decoding).	R/W	3
		AMB	3-2	Output channels 3 and 4 format selector. (See above for decoding).	R/W	3
		AMA	1-0	Output channels 1 and 2 format selector. (See above for decoding).	R/W	3

Table 4-29: SD Audio Core Configuration and Status Registers (Continued)

Address	Register Name	Bit Name	Bit	Description	R/W	Default
409h	OUTPUT_SEL_1	RSVD	15-12	Reserved.	R/W	0
		OP4_SRC	11-9	Output channel 4 source selector. 000: Primary audio group channel 1 001: Primary audio group channel 2 010: Primary audio group channel 3 011: Primary audio group channel 4 100: Secondary audio group channel 1 101: Secondary audio group channel 2 110: Secondary audio group channel 3 111: Secondary audio group channel 4	R/W	3
		OP3_SRC	8-6	Output channel 3 source selector (Decode as above).	R/W	2
		OP2_SRC	5-3	Output channel 2 source selector (Decode as above).	R/W	1
		OP1_SRC	2-0	Output channel 1 source selector (Decode as above).	R/W	0
40Ah	OUTPUT_SEL_2	RSVD	15-12	Reserved.	R/W	0
		OP8_SRC	11-9	Output channel 8 source selector. 000: Primary audio group channel 1 001: Primary audio group channel 2 010: Primary audio group channel 3 011: Primary audio group channel 4 100: Secondary audio group channel 1 101: Secondary audio group channel 2 110: Secondary audio group channel 3 111: Secondary audio group channel 4	R/W	7
		OP7_SRC	8-6	Output channel 7 source selector (Decode as above).	R/W	6
		OP6_SRC	5-3	Output channel 6 source selector (Decode as above).	R/W	5
		OP5_SRC	2-0	Output channel 5 source selector (Decode as above).	R/W	4
40Bh - 41Fh	RSVD	RSVD	–	Reserved.	–	–

Table 4-29: SD Audio Core Configuration and Status Registers (Continued)

Address	Register Name	Bit Name	Bit	Description	R/W	Default
420h	AFNA12	RSVD	15-9	Reserved.	R/W	0
		AFN1_2A	8-0	Primary group audio frame number for channels 1 and 2.	R	0
421h	AFNA34	RSVD	15-9	Reserved.	R/W	0
		AFN3_4A	8-0	Primary group audio frame number for channels 3 and 4.	R	0
422h	RATEA	RSVD	15-8	Reserved.	R/W	0
		RATE3_4A	7-5	Primary group sampling frequency for channels 3 and 4	R	0
		ASX3_4A	4	Primary group asynchronous mode for channels 3 and 4.	R	0
		RATE1_2A	3-1	Primary group sampling frequency for channels 1 and 2.	R	0
		ASX1_2A	0	Primary group asynchronous mode for channels 1 and 2.	R	0
423h	ACT_A	RSVD	15-4	Reserved.	R/W	0
		ACTA	3-0	Primary group active channels.	R	0
424h	PRIM_AUD_DELAY_1	RSVD	15-9	Reserved.	R/W	0
		DEL1A_1	8-1	Primary Audio group delay data for channel 1.	R	0
		EBIT1A	0	Primary Audio group delay data valid flag for channel 1.	R	0
425h	PRIM_AUD_DELAY_2	RSVD	15-9	Reserved.	R/W	0
		DEL1A_2	8-0	Primary Audio group delay data for channel 1.	R	0
426h	PRIM_AUD_DELAY_3	RSVD	15-9	Reserved.	R/W	0
		DEL1A_3	8-0	Primary Audio group delay data for channel 1.	R	0
427h	PRIM_AUD_DELAY_4	RSVD	15-9	Reserved.	R/W	0
		DEL2A_4	8-1	Primary Audio group delay data for channel 2.	R	0
		EBIT2A	0	Primary Audio group delay data valid flag for channel 2.	R	0
428h	PRIM_AUD_DELAY_5	RSVD	15-9	Reserved.	R/W	0
		DEL2A_5	8-0	Primary Audio group delay data for channel 2.	R	0
429h	PRIM_AUD_DELAY_6	RSVD	15-9	Reserved.	R/W	0
		DEL2A_6	8-0	Primary Audio group delay data for channel 2.	R	0

Table 4-29: SD Audio Core Configuration and Status Registers (Continued)

Address	Register Name	Bit Name	Bit	Description	R/W	Default
42Ah	PRIM_AUD_DELAY_7	RSVD	15-9	Reserved.	R/W	0
		DEL3A_7	8-1	Primary Audio group delay data for channel 3.	R	0
		EBIT3A	0	Primary Audio group delay data valid flag for channel 3.	R	0
42Bh	PRIM_AUD_DELAY_8	RSVD	15-9	Reserved.	R/W	0
		DEL3A_8	8-0	Primary Audio group delay data for channel 3.	R	0
42Ch	PRIM_AUD_DELAY_9	RSVD	15-9	Reserved.	R/W	0
		DEL3A_9	8-0	Primary Audio group delay data for channel 3.	R	0
42Dh	PRIM_AUD_DELAY_10	RSVD	15-9	Reserved.	R/W	0
		DEL4A_10	8-1	Primary Audio group delay data for channel 4.	R	0
		EBIT4A	0	Primary Audio group delay data valid flag for channel 4.	R	0
42Eh	PRIM_AUD_DELAY_11	RSVD	15-9	Reserved.	R/W	0
		DEL4A_11	8-0	Primary Audio group delay data for channel 4.	R	0
42Fh	PRIM_AUD_DELAY_12	RSVD	15-9	Reserved.	R/W	0
		DEL4A_12	8-0	Primary Audio group delay data for channel 4.	R	0
430h	AFNB12	RSVD	15-9	Reserved.	R/W	0
		AFN1_2B	8-0	Secondary group audio frame number for channels 1 and 2.	R	0
431h	AFNB34	RSVD	15-9	Reserved.	R/W	0
		AFN3_4B	8-0	Secondary group audio frame number for channels 3 and 4.	R	0
432h	RATEB	RSVD	15-8	Reserved.	R	0
		RATE3_4B	7-5	Secondary group sampling frequency for channels 3 and 4.	R	0
		ASX3_4B	4	Secondary group asynchronous mode for channels 3 and 4.	R	0
		RATE1_2B	3-1	Secondary group sampling frequency for channels 1 and 2.	R	0
		ASX1_2B	0	Secondary group asynchronous mode for channels 1 and 2.	R	0
433h	ACT_B	RSVD	15-4	Reserved.	R/W	0
		ACTB	3-0	Secondary group active channels.	R	0

Table 4-29: SD Audio Core Configuration and Status Registers (Continued)

Address	Register Name	Bit Name	Bit	Description	R/W	Default
434h	SEC_AUD_DELAY_1	RSVD	15-9	Reserved.	R/W	0
		DEL1B_1	8-1	Secondary Audio group delay data for channel 1.	R	0
		EBIT1B	0	Secondary Audio group delay data valid flag for channel 1.	R	0
435h	SEC_AUD_DELAY_2	RSVD	15-9	Reserved.	R/W	0
		DEL1B_2	8-0	Secondary Audio group delay data for channel 1.	R	0
436h	SEC_AUD_DELAY_3	RSVD	15-9	Reserved.	R/W	0
		DEL1B_3	8-0	Secondary Audio group delay data for channel 1.	R	0
437h	SEC_AUD_DELAY_4	RSVD	15-9	Reserved.	R/W	0
		DEL2B_4	8-1	Secondary Audio group delay data for channel 2.	R	0
		EBIT2B	0	Secondary Audio group delay data valid flag for channel 2.	R	0
438h	SEC_AUD_DELAY_5	RSVD	15-9	Reserved.	R/W	0
		DEL2B_5	8-0	Secondary Audio group delay data for channel 2.	R	0
439h	SEC_AUD_DELAY_6	RSVD	15-9	Reserved.	R/W	0
		DEL2B_6	8-0	Secondary Audio group delay data for channel 2.	R	0
43Ah	SEC_AUD_DELAY_7	RSVD	15-9	Reserved.	R/W	0
		DEL3B_7	8-1	Secondary Audio group delay data for channel 3.	R	0
		EBIT3B	0	Secondary Audio group delay data valid flag for channel 3.	R	0
43Bh	SEC_AUD_DELAY_8	RSVD	15-9	Reserved.	R/W	0
		DEL3B_8	8-0	Secondary Audio group delay data for channel 3.	R	0
43Ch	SEC_AUD_DELAY_9	RSVD	15-9	Reserved.	R/W	0
		DEL3B_9	8-0	Secondary Audio group delay data for channel 3.	R	0
43Dh	SEC_AUD_DELAY_10	RSVD	15-9	Reserved.	R/W	0
		DEL4B_10	8-1	Secondary Audio group delay data for channel 4.	R	0
		EBIT4B	0	Secondary Audio group delay data valid flag for channel 4.	R	0

Table 4-29: SD Audio Core Configuration and Status Registers (Continued)

Address	Register Name	Bit Name	Bit	Description	R/W	Default
43Eh	SEC_AUD_DELAY_11	RSVD	15-9	Reserved.	R/W	0
		DEL4B_11	8-0	Secondary Audio group delay data for channel 4.	R	0
43Fh	SEC_AUD_DELAY_12	RSVD	15-9	Reserved.	R/W	0
		DEL4B_12	8-0	Secondary Audio group delay data for channel 4.	R	0
440h	ACSR1_2A_BYTE_0_1	ACSR1_2A_0	15-0	Bytes 0 [7:0] and 1 [15:8] of audio group A channel status for channels 1 and 2	R	0
441h	ACSR1_2A_BYTE_2_3	ACSR1_2A_2	15-0	Bytes 2 [7:0] and 3 [15:8] of audio group A channel status for channels 1 and 2	R	0
442h	ACSR1_2A_BYTE_4_5	ACSR1_2A_4	15-0	Bytes 4 [7:0] and 5 [15:8] of audio group A channel status for channels 1 and 2	R	0
443h	ACSR1_2A_BYTE_6_7	ACSR1_2A_6	15-0	Bytes 6 [7:0] and 7 [15:8] of audio group A channel status for channels 1 and 2	R	0
444h	ACSR1_2A_BYTE_8_9	ACSR1_2A_8	15-0	Bytes 8 [7:0] and 9 [15:8] of audio group A channel status for channels 1 and 2.	R	0
445H	ACSR1_2A_BYTE_10_11	ACSR1_2A_10	15-0	Bytes 10 [7:0] and 11 [15:8] of audio group A channel status for channels 1 and 2.	R	0
446H	ACSR1_2A_BYTE_12_13	ACSR1_2A_12	15-0	Bytes 12 [7:0] and 13 [15:8] of audio group A channel status for channels 1 and 2.	R	0
447h	ACSR1_2A_BYTE_14_15	ACSR1_2A_14	15-0	Bytes 14 [7:0] and 15 [15:8] of audio group A channel status for channels 1 and 2.	R	0
448h	ACSR1_2A_BYTE_16_17	ACSR1_2A_16	15-0	Bytes 16 [7:0] and 17 [15:8] of audio group A channel status for channels 1 and 2.	R	0
449h	ACSR1_2A_BYTE_18_19	ACSR1_2A_18	15-0	Bytes 18 [7:0] and 19 [15:8] of audio group A channel status for channels 1 and 2.	R	0
44Ah	ACSR1_2A_BYTE_20_21	ACSR1_2A_20	15-0	Bytes 20 [7:0] and 21 [15:8] of audio group A channel status for channels 1 and 2.	R	0
44Bh	ACRS1_2A_BYTE22	RSVD	15-8	Reserved.	R/W	0
		ACSR1_2A_22	7-0	Bytes 22 of audio group A channel status for channels 1 and 2.	R	0
44Ch - 44Fh	RSVD	RSVD	15-0	Reserved.	R/W	0

Table 4-29: SD Audio Core Configuration and Status Registers (Continued)

Address	Register Name	Bit Name	Bit	Description	R/W	Default
450h	ACSR3_4A_BYTE0_1	ACSR3_4A_0	15-0	Bytes 0 [7:0] and 1 [15:8] of audio group A channel status for channels 3 and 4.	R	0
451h	ACSR3_4A_BYTE2_3	ACSR3_4A_2	15-0	Bytes 2 [7:0] and 3 [15:8] of audio group A channel status for channels 3 and 4.	R	0
452h	ACSR3_4A_BYTE4_5	ACSR3_4A_4	15-0	Bytes 4 [7:0] and 5 [15:8] of audio group A channel status for channels 3 and 4.	R	0
453h	ACSR3_4A_BYTE6_7	ACSR3_4A_6	15-0	Bytes 6 [7:0] and 7 [15:8] of audio group A channel status for channels 3 and 4.	R	0
454h	ACSR3_4A_BYTE8_9	ACSR3_4A_8	15-0	Bytes 8 [7:0] and 9 [15:8] of audio group A channel status for channels 3 and 4.	R	0
455h	ACSR3_4A_BYTE10_11	ACSR3_4A_10	15-0	Bytes 10 [7:0] and 11 [15:8] of audio group A channel status for channels 3 and 4.	R	0
456h	ACSR3_4A_BYTE12_13	ACSR3_4A_12	15-0	Bytes 12 [7:0] and 13 [15:8] of audio group A channel status for channels 3 and 4.	R	0
457h	ACSR3_4A_BYTE14_15	ACSR3_4A_14	15-0	Bytes 14 [7:0] and 15 [15:8] of audio group A channel status for channels 3 and 4.	R	0
458h	ACSR3_4A_BYTE16_17	ACSR3_4A_16	15-0	Bytes 16 [7:0] and 17 [15:8] of audio group A channel status for channels 3 and 4.	R	0
459h	ACSR3_4A_BYTE18_19	ACSR3_4A_18	15-0	Bytes 18 [7:0] and 19 [15:8] of audio group A channel status for channels 3 and 4.	R	0
45Ah	ACSR3_4A_BYTE20_21	ACSR3_4A_20	15-0	Bytes 20 [7:0] and 21 [15:8] of audio group A channel status for channels 3 and 4.	R	0
45Bh	ACSR3_4A_BYTE22	RSVD	15-8	Reserved.	R/W	0
		ACSR3_4A_22	7-0	Bytes 22 of audio group A channel status for channels 3 and 4.	R	0
45Ch - 45Fh	RSVD	RSVD	15-0	Reserved.	R/W	0
460h	ACSR1_2B_BYTE0_1	ACSR1_2B_0	15-0	Bytes 0 [7:0] and 1 [15:8] of audio group B channel status for channels 1 and 2.	R	0
461h	ACSR1_2B_BYTE2_3	ACSR1_2B_2	15-0	Bytes 2 [7:0] and 3 [15:8] of audio group B channel status for channels 1 and 2.	R	0
462h	ACSR1_2B_BYTE4_5	ACSR1_2B_4	15-0	Bytes 4 [7:0] and 5 [15:8] of audio group B channel status for channels 1 and 2.	R	0

Table 4-29: SD Audio Core Configuration and Status Registers (Continued)

Address	Register Name	Bit Name	Bit	Description	R/W	Default
463h	ACSR1_2B_BYTE 6_7	ACSR1_2B_6	15-0	Bytes 6 [7:0] and 7 [15:8] of audio group B channel status for channels 1 and 2.	R	0
464h	ACSR1_2B_BYTE 8_9	ACSR1_2B_8	15-0	Bytes 8 [7:0] and 9 [15:8] of audio group B channel status for channels 1 and 2.	R	0
465h	ACSR1_2B_BYTE 10_11	ACSR1_2B_10	15-0	Bytes 10 [7:0] and 11 [15:8] of audio group B channel status for channels 1 and 2.	R	0
466h	ACSR1_2B_BYTE 12_13	ACSR1_2B_12	15-0	Bytes 12 [7:0] and 13 [15:8] of audio group B channel status for channels 1 and 2.	R	0
467h	ACSR1_2B_BYTE 14_15	ACSR1_2B_14	15-0	Bytes 14 [7:0] and 15 [15:8] of audio group B channel status for channels 1 and 2.	R	0
468h	ACSR1_2B_BYTE 16_17	ACSR1_2B_16	15-0	Bytes 16 [7:0] and 17 [15:8] of audio group B channel status for channels 1 and 2.	R	0
469h	ACSR1_2B_BYTE 18_19	ACSR1_2B_18	15-0	Bytes 18 [7:0] and 19 [15:8] of audio group B channel status for channels 1 and 2.	R	0
46Ah	ACSR1_2B_BYTE 20_21	ACSR1_2B_20	15-0	Bytes 20 [7:0] and 21 [15:8] of audio group B channel status for channels 1 and 2.	R	0
46Bh	ACSR1_2B_BYTE 22	RSVD	15-8	Reserved.	R/W	0
		ACSR1_2B_22	7-0	Bytes 22 of audio group B channel status for channels 1 and 2.	R	0
46Ch - 46Fh	RSVD	RSVD	15-0	Reserved.	R/W	0
470h	ACSR3_4B_BYTE 0_1	ACSR3_4B_0	15-0	Bytes 0 [7:0] and 1 [15:8] of audio group B channel status for channels 3 and 4.	R	0
471h	ACSR3_4B_BYTE 2_3	ACSR3_4B_2	15-0	Bytes 2 [7:0] and 3 [15:8] of audio group B channel status for channels 3 and 4.	R	0
472h	ACSR3_4B_BYTE 4_5	ACSR3_4B_4	15-0	Bytes 4 [7:0] and 5 [15:8] of audio group B channel status for channels 3 and 4.	R	0
473h	ACSR3_4B_BYTE 6_7	ACSR3_4B_6	15-0	Bytes 6 [7:0] and 7 [15:8] of audio group B channel status for channels 3 and 4.	R	0
474h	ACSR3_4B_BYTE 8_9	ACSR3_4B_8	15-0	Bytes 8 [7:0] and 9 [15:8] of audio group B channel status for channels 3 and 4.	R	0
475h	ACSR3_4B_BYTE 10_11	ACSR3_4B_10	15-0	Bytes 10 [7:0] and 11 [15:8] of audio group B channel status for channels 3 and 4.	R	0

Table 4-29: SD Audio Core Configuration and Status Registers (Continued)

Address	Register Name	Bit Name	Bit	Description	R/W	Default
476h	ACSR3_4B_BYTE_12_13	ACSR3_4B_12	15-0	Bytes 12 [7:0] and 13 [15:8] of audio group B channel status for channels 3 and 4.	R	0
477h	ACSR3_4B_BYTE_14_15	ACSR3_4B_14	15-0	Bytes 14 [7:0] and 15 [15:8] of audio group B channel status for channels 3 and 4.	R	0
478h	ACSR3_4A_BYTE_16_17	ACSR3_4B_16	15-0	Bytes 16 [7:0] and 17 [15:8] of audio group B channel status for channels 3 and 4.	R	0
479h	ACSR3_4A_BYTE_18_19	ACSR3_4B_18	15-0	Bytes 18 [7:0] and 19 [15:8] of audio group B channel status for channels 3 and 4.	R	0
47Ah	ACSR3_4A_BYTE_20_21	ACSR3_4B_20	15-0	Bytes 20 [7:0] and 21 [15:8] of audio group B channel status for channels 3 and 4.	R	0
47Bh	ACSR3_4A_BYTE_22	RSVD	15-8	Reserved.	R/W	0
		ACSR3_4B_22	7-0	Bytes 22 of audio group B channel status for channels 3 and 4.	R	0
47Ch - 47Fh	RSVD	RSVD	15-0	Reserved.	R/W	0
480h	ACSR_BYTE_0	ACSR_BYTE0	7-0	Audio channel status to use when ACS_REGEN is set or when adding audio channel status to non-AES/EBU audio. 8 bits per register for 23 registers.	R	0
481h	ACSR_BYTE_1	ACSR_BYTE1	7-0	–	W	0
482h	ACSR_BYTE_2	ACSR_BYTE2	7-0	–	W	0
483h	ACSR_BYTE_3	ACSR_BYTE3	7-0	–	W	0
484h	ACSR_BYTE_4	ACSR_BYTE4	7-0	–	W	0
485h	ACSR_BYTE_5	ACSR_BYTE5	7-0	–	W	0
486h	ACSR_BYTE_6	ACSR_BYTE6	7-0	–	W	0
487h	ACSR_BYTE_7	ACSR_BYTE7	7-0	–	W	0
488h	ACSR_BYTE_8	ACSR_BYTE8	7-0	–	W	0
489h	ACSR_BYTE_9	ACSR_BYTE9	7-0	–	W	0
48Ah	ACSR_BYTE_10	ACSR_BYTE10	7-0	–	W	0
48Bh	ACSR_BYTE_11	ACSR_BYTE11	7-0	–	W	0
48Ch	ACSR_BYTE_12	ACSR_BYTE12	7-0	–	W	0
48Dh	ACSR_BYTE_13	ACSR_BYTE13	7-0	–	W	0
48Eh	ACSR_BYTE_14	ACSR_BYTE14	7-0	–	W	0
48Fh	ACSR_BYTE_15	ACSR_BYTE15	7-0	–	W	0
490h	ACSR_BYTE_16	ACSR_BYTE16	7-0	–	W	0

Table 4-29: SD Audio Core Configuration and Status Registers (Continued)

Address	Register Name	Bit Name	Bit	Description	R/W	Default
491h	ACSR_BYTE_17	ACSR_BYTE17	7-0	–	W	0
492h	ACSR_BYTE_18	ACSR_BYTE18	7-0	–	W	0
493h	ACSR_BYTE_19	ACSR_BYTE19	7-0	–	W	0
494h	ACSR_BYTE_20	ACSR_BYTE20	7-0	–	R/W	0
495h	ACSR_BYTE_21	ACSR_BYTE21	7-0	–	R/W	0
496h	ACSR_BYTE_22	ACSR_BYTE22	7-0	–	R/W	0

4.20.3 HD Audio Core Registers

NOTE: The GS1671 only accepts write/read commands to/from the HD Audio Register Map when the audio core is locked to the incoming HD video format.

Table 4-30: HD Audio Core Configuration and Status Registers

Address	Register Name	Bit Name	Bit	Description	R/W	Default
200h	CFG_AUD	ECC_OFF	15	Disables ECC error correction.	R/W	0
		ALL_DEL	14	Selects deletion of all audio data and all audio control packets 0: Do not delete existing audio control packets 1: Delete existing audio control packets.	R/W	0
		MUTE_ALL	13	Mute all output channels 0: Normal 1: Muted	R/W	0
		ACS_USE_SECOND	12	Extract Audio Channel Status from second channel pair.	R/W	0
		ASWLB	11-10	Secondary group output word length. 00: 24 bits 01: 20 bits 10: 16 bits 11: invalid	R/W	3
		ASWLA	9-8	Primary group output word length. 00: 24 bits 01: 20 bits 10: 16 bits 11: invalid	R/W	3
		AMB	7-6	Secondary group output format selector. 00: AES/EBU audio output 01: Serial audio output: left justified MSB first 10: Serial audio output: right justified. MSB first 11: I2S serial audio output	R/W	3
		AMA	5-4	Primary group output format selector. 00: AES/EBU audio output 01: Serial audio output: left justified MSB first 10: Serial audio output: right justified MSB first 11: I2S serial audio output	R/W	3

Table 4-30: HD Audio Core Configuration and Status Registers (Continued)

Address	Register Name	Bit Name	Bit	Description	R/W	Default
200h	CFG_AUD	IDB	3-2	Specifies the Secondary audio group to extract. 00: Audio group #1 01: Audio group #2 10: Audio group #3 11: Audio group #4 Note: Should IDA and IDB be set to the same value, they automatically revert to their default values.	R/W	1
		IDA	1-0	Specifies the Primary audio group to extract. 00: Audio group #1 01: Audio group #2 10: Audio group #3 11: Audio group #4 Note: Should IDA and IDB be set to the same value, they automatically revert to their default values.	R/W	0
201h	ACS_DET	RSVD	15-8	Reserved.	R/W	0
		DBNB_ERR	7	Set when Secondary group audio Data Block Number sequence is discontinuous.	ROCW	0
		DBNA_ERR	6	Set when Primary group audio Data Block Number sequence is discontinuous.	ROCW	0
		CTRB_DET	5	Set when Secondary group audio control packet is detected.	ROCW	0
		CTRA_DET	4	Set when Primary group audio control packet is detected.	ROCW	0
		ACS_DET3_4B	3	Secondary group audio status detected for channels 3 and 4.	ROCW	0
		ACS_DET1_2B	2	Secondary group audio status detected for channels 1 and 2.	ROCW	0
		ACS_DET3_4A	1	Primary group audio status detected for channels 3 and 4.	ROCW	0
ACS_DET1_2A	0	Primary group audio status detected for channels 1 and 2.	ROCW	0		

Table 4-30: HD Audio Core Configuration and Status Registers (Continued)

Address	Register Name	Bit Name	Bit	Description	R/W	Default
202h	AUD_DET1	RSVD	15-9	Reserved.	R	0
		IDB_READBACK	8-7	Actual value of IDB in the hardware.	R	1
		IDA_READBACK	6-5	Actual value of IDA in the hardware.	R	0
		ADPG4_DET	4	Set while Group 4 audio data packets are detected.	R	0
		ADPG3_DET	3	Set while Group 3 audio data packets are detected.	R	0
		ADPG2_DET	2	Set while Group 2 audio data packets are detected.	R	0
		ADPG1_DET	1	Set while Group 1 audio data packets are detected.	R	0
		ACS_APPLY_WAIT	0	ACS_APPLY_WAIT: Set while output channels 1 and 2 are waiting for a status boundary to apply the ACSR[183:0] data.	R	0
203h	AUD_DET2	RSVD	15-2	Reserved.	R/W	0
		ECCA_ERROR	1	Primary group audio data packet error detected.	ROCW	0
		ECCB_ERROR	0	Secondary group audio data packet error detected.	ROCW	0
204h	REGEN	RSVD	15-2	Reserved.	R/W	0
		ACS_APPLY	1	Cause channel status data in ACSR[183:0] to be transferred to the channel status replacement mechanism. The transfer does not occur until the next status boundary.	R/W	0
		ACS_REGEN	0	Specifies that Audio Channel Status of all channels should be replaced with ACSR[183:0] field. 0: Do not replace Channel Status 1: Replace Channel Status of all channels	R/W	0
205h	CH_MUTE	RSVD	15	Reserved.	R/W	0
		MUTEB	7-4	Mute Secondary output channels 4..1 Where bits 7:4 = channel 4:1 1: Mute 0: Normal	R/W	0
		MUTEA	3-0	Mute Primary output channels 4..1 Where bits 3:0 = channel 4:1 1: Mute 0: Normal	R/W	0

Table 4-30: HD Audio Core Configuration and Status Registers (Continued)

Address	Register Name	Bit Name	Bit	Description	R/W	Default
206h	CH_VALID	RSVD	15-8	Reserved.	R/W	0
		CH4_VALIDB	7	Secondary group channel 4 sample validity flag.	R	0
		CH3_VALIDB	6	Secondary group channel 3 sample validity flag.	R	0
		CH2_VALIDB	5	Secondary group channel 2 sample validity flag.	R	0
		CH1_VALIDB	4	Secondary group channel 1 sample validity flag.	R	0
		CH4_VALIDA	3	Primary group channel 4 sample validity flag.	R	0
		CH3_VALIDA	2	Primary group channel 3 sample validity flag.	R	0
		CH2_VALIDA	1	Primary group channel 2 sample validity flag.	R	0
		CH1_VALIDA	0	Primary group channel 1 sample validity flag.	R	0

Table 4-30: HD Audio Core Configuration and Status Registers (Continued)

Address	Register Name	Bit Name	Bit	Description	R/W	Default
207h	HD_AUDIO_ERR OR_MASK	RSVD	15	Reserved.	R/W	0
		EN_MISSING_PHASE	14	Asserts $\overline{\text{AUDIO_ERROR}}$ when chosen group's phase data is missing	R/W	0
		EN_ACS_DET3_4B	13	Asserts $\overline{\text{AUDIO_ERROR}}$ when ACS_DET3_4B flag is set.	R/W	0
		EN_ACS_DET1_2B	12	Asserts $\overline{\text{AUDIO_ERROR}}$ when ACS_DET1_2B flag is set.	R/W	0
		EN_ACS_DET3_4A	11	Asserts $\overline{\text{AUDIO_ERROR}}$ when ACS_DET3_4A flag is set.	R/W	0
		EN_ACS_DET1_2A	10	Asserts $\overline{\text{AUDIO_ERROR}}$ when ACS_DET1_2A flag is set.	R/W	0
		EN_CTRB_DET	9	Asserts $\overline{\text{AUDIO_ERROR}}$ when CTRB_DET flag is set.	R/W	0
		EN_CTRA_DET	8	Asserts $\overline{\text{AUDIO_ERROR}}$ when CTRA_DET flag is set.	R/W	0
		EN_DBNB_ERR	7	Asserts $\overline{\text{AUDIO_ERROR}}$ when DBNB_ERR flag is set.	R/W	0
		EN_DBNA_ERR	6	Asserts $\overline{\text{AUDIO_ERROR}}$ when DBNA_ERR flag is set.	R/W	0
		EN_ECCB_ERR	5	Asserts $\overline{\text{AUDIO_ERROR}}$ when ECCB_ERR flag is set.	R/W	0
		EN_ECCA_ERR	4	Asserts $\overline{\text{AUDIO_ERROR}}$ when ECCA_ERR flag is set.	R/W	0
		EN_ADPG4_DET	3	Asserts $\overline{\text{AUDIO_ERROR}}$ when ADPG4_DET flag is set.	R/W	0
		EN_ADPG3_DET	2	Asserts $\overline{\text{AUDIO_ERROR}}$ when ADPG3_DET flag is set.	R/W	0
EN_ADPG2_DET	1	Asserts $\overline{\text{AUDIO_ERROR}}$ when ADPG2_DET flag is set.	R/W	0		
EN_ADPG1_DET	0	Asserts $\overline{\text{AUDIO_ERROR}}$ when ADPG1_DET flag is set.	R/W	0		

Table 4-30: HD Audio Core Configuration and Status Registers (Continued)

Address	Register Name	Bit Name	Bit	Description	R/W	Default
208h	CFG_AUD_2	RSVD	15-11	Reserved.	R/W	0
		SEL_PHASE_SRC	10	Selects between the Primary and Secondary embedded phase info.	R/W	0
		LSB_FIRSTB	9	Causes the Secondary group serial output formats to use LSB first.	R/W	0
		LSB_FIRSTA	8	Causes the Primary group serial output formats to use LSB first.	R/W	0
		FORCE_M	7	Disables M value detection and forces M value to that specified by FORCE_MEQ1001.	R/W	0
		FORCE_MEQ1001	6	Specifies M value when FORCE_M is set. 1: M= 1.001 0: M = 1.000	R/W	0
		IGNORE_PHASE	5	Causes the Demultiplexer to ignore the embedded clock info in both the Primary and Secondary group audio data packets. Clock is generated based on the video format and M value.	R/W	0
		FORCE_ACLK128	4	Causes the core to ignore embedded clock info and derive phase information from ACLK128.	R/W	0
		EN_NOT_LOCKED	3	Asserts $\overline{\text{AUDIO_ERROR}}$ when locked is not asserted.	R/W	0
		EN_NO_VIDEO	2	Asserts $\overline{\text{AUDIO_ERROR}}$ when the video format is unknown.	R/W	0
		EN_NO_PHASEB	1	Asserts $\overline{\text{AUDIO_ERROR}}$ when NO_PHASEB_DATA is set.	R/W	0
EN_NO_PHASEA	0	Asserts $\overline{\text{AUDIO_ERROR}}$ when NO_PHASEA_DATA is set.	R/W	0		
209h	CFG_AUD_3	RSVD	15-3	Reserved.	R/W	0
		MISSING_PHASE	2	Embedded phase info for chosen group missing or incorrect.	R	0
		NO_PHASEB_DATA	1	Secondary group has invalid embedded clock information.	R	0
		NO_PHASEA_DATA	0	Primary group has invalid embedded clock information.	R	0

Table 4-30: HD Audio Core Configuration and Status Registers (Continued)

Address	Register Name	Bit Name	Bit	Description	R/W	Default
20Ah	OUTPUT_SEL_1	RSVD	15-12	Reserved.	R	0
		OP4_SRC	11-9	Output channel 4 source selector. 000: Primary audio group channel 1 001: Primary audio group channel 2 010: Primary audio group channel 3 011: Primary audio group channel 4 100: Secondary audio group channel 1 101: Secondary audio group channel 2 110: Secondary audio group channel 3 111: Secondary audio group channel 4	R/W	3
		OP3_SRC	8-6	Output channel 3 source selector (Decode as above).	R/W	2
		OP2_SRC	5-3	Output channel 2 source selector (Decode as above).	R/W	1
		OP1_SRC	2-0	Output channel 1 source selector (Decode as above).	R/W	0
20Bh	OUTPUT_SEL_2	RSVD	15-12	Reserved.	R/W	0
		OP8_SRC	11-9	Output channel 8 source selector. 000: Primary audio group channel 1 001: Primary audio group channel 2 010: Primary audio group channel 3 011: Primary audio group channel 4 100: Secondary audio group channel 1 101: Secondary audio group channel 2 110: Secondary audio group channel 3 111: Secondary audio group channel 4	R/W	7
		OP7_SRC	8-6	Output channel 7 source selector (Decode as above).	R/W	6
		OP6_SRC	5-3	Output channel 6 source selector (Decode as above).	R/W	5
		OP5_SRC	2-0	Output channel 5 source selector (Decode as above).	R/W	4
20Ch - 21Fh	RSVD	RSVD	–	Reserved.	–	–
220h	AFNA	RSVD	15-9	Reserved.	R/W	0
		AFNA	8-0	Primary group audio frame number.	R	0

Table 4-30: HD Audio Core Configuration and Status Registers (Continued)

Address	Register Name	Bit Name	Bit	Description	R/W	Default
221h	RATEA	RSVD	15-4	Reserved.	R/W	0
		RATEA	3-1	Primary group sampling frequency for channels 1 and 2.	R	0
		ASXA	0	Primary group asynchronous mode for channels 1 and 2.	R	0
222h	ACTA	RSVD	15-4	Reserved.	R/W	0
		ACTA	3-0	Primary group active channels.	R	0
223h	PRIM_AUD_DELAY_1	RSVD	15-9	Reserved.	R/W	0
		DEL1_2A_1	8-1	Primary Audio group delay data for channels 1 and 2 [7:0].	R	0
		EBIT1_2A	0	Primary Audio group delay data valid flag for channels 1 and 2.	R	0
224h	PRIM_AUD_DELAY_2	RSVD	15-9	Reserved.	R/W	0
		DEL1_2A_2	8-0	Primary Audio group delay data for channels 1 and 2 [16:8].	R	0
225h	PRIM_AUD_DELAY_3	RSVD	15-9	Reserved.	R/W	0
		DEL1_2A_3	8-0	Primary Audio group delay data for channels 1 and 2 [25:17].	R	0
226h	PRIM_AUD_DELAY_4	RSVD	15-9	Reserved.	R/W	0
		DEL3_4A_4	8-1	Primary Audio group delay data for channels 3 and 4 [7:0].	R	0
		EBIT3_4A	0	Primary Audio group delay data valid flag for channels 3 and 4.	R	0
227h	PRIM_AUD_DELAY_5	RSVD	15-9	Reserved.	R/W	0
		DEL3_4A_5	8-0	Primary Audio group delay data for channels 3 and 4 [16:8].	R	0
228h	PRIM_AUD_DELAY_6	RSVD	15-9	Reserved.	R/W	0
		DEL3_4A_6	8-0	Primary Audio group delay data for channels 3 and 4 [25:17].	R	0
229h - 22Fh	RSVD	RSVD	–	Reserved.	R/W	0
230h	AFNB	RSVD	15-9	Reserved.	R/W	0
		AFNB	8-0	Secondary group audio frame number.	R	0
231h	RATEB	RSVD	15-4	Reserved.	R/W	0
		RATEB	3-1	Secondary group sampling frequency for channels 1 and 2.	R	0
		ASXB	0	Secondary group asynchronous mode for channels 1 and 2.	R	0

Table 4-30: HD Audio Core Configuration and Status Registers (Continued)

Address	Register Name	Bit Name	Bit	Description	R/W	Default
232h	ACTB	RSVD	15-4	Reserved.	R/W	0
		ACTB	3-0	Secondary group active channels.	R	0
233h	SEC_AUD_DELAY_1	RSVD	15-9	Reserved.	R/W	0
		DEL1_2B_1	8-1	Secondary Audio group delay data valid flag for channels 1 and 2.	R	0
		EBIT1_2B	0	Secondary Audio group delay data for channels 1 and 2 [7:0].	R	0
234h	SEC_AUD_DELAY_2	RSVD	15-9	Reserved.	R/W	0
		DEL1_2B_2	8-0	Secondary Audio group delay data for channels 1 and 2 [16:8].	R	0
235h	SEC_AUD_DELAY_3	RSVD	15-9	Reserved.	R/W	0
		DEL1_2B_3	8-0	Secondary Audio group delay data for channels 1 and 2 [25:17].	R	0
236h	SEC_AUD_DELAY_4	RSVD	15-9	Reserved.	R/W	0
		DEL3_4B_4	8-1	Secondary Audio group delay data for channels 3 and 4 [7:0].	R	0
		EBIT3_4B	0	Secondary Audio group delay data valid flag for channels 3 and 4.	R	0
237h	SEC_AUD_DELAY_5	RSVD	15-9	Reserved.	R/W	0
		DEL3_4B_5	8-0	Secondary Audio group delay data for channels 3 and 4 [16:8].	R	0
238h	SEC_AUD_DELAY_6	RSVD	15-9	Reserved.	R/W	0
		DEL3_4B_6	8-0	Secondary Audio group delay data for channels 3 and 4 [25:17].	R	0
239h - 23Fh	RSVD	RSVD	–	Reserved.	R/W	0
240h	ACSR1_2A_BYTE_0_1	ACSR1_2A_0	15-0	Bytes 0 [7:0] and 1 [15:8] of audio group A channel status for channels 1 and 2.	R	0
241h	ACSR1_2A_BYTE_2_3	ACSR1_2A_2	15-0	Bytes 2 [7:0] and 3 [15:8] of audio group A channel status for channels 1 and 2.	R	0
242h	ACSR1_2A_BYTE_4_5	ACSR1_2A_4	15-0	Bytes 4 [7:0] and 5 [15:8] of audio group A channel status for channels 1 and 2.	R	0
243h	ACSR1_2A_BYTE_6_7	ACSR1_2A_6	15-0	Bytes 6 [7:0] and 7 [15:8] of audio group A channel status for channels 1 and 2.	R	0
244h	ACSR1_2A_BYTE_8_9	ACSR1_2A_8	15-0	Bytes 8 [7:0] and 9 [15:8] of audio group A channel status for channels 1 and 2.	R	0

Table 4-30: HD Audio Core Configuration and Status Registers (Continued)

Address	Register Name	Bit Name	Bit	Description	R/W	Default
245h	ACSR1_2A_BYTE 10_11	ACSR1_2A_10	15-0	Bytes 10 [7:0] and 11 [15:8] of audio group A channel status for channels 1 and 2.	R	0
246h	ACSR1_2A_BYTE 12_13	ACSR1_2A_12	15-0	Bytes 12 [7:0] and 13 [15:8] of audio group A channel status for channels 1 and 2.	R	0
247h	ACSR1_2A_BYTE 14_15	ACSR1_2A_14	15-0	Bytes 14 [7:0] and 15 [15:8] of audio group A channel status for channels 1 and 2.	R	0
248h	ACSR1_2A_BYTE 16_17	ACSR1_2A_16	15-0	Bytes 16 [7:0] and 17 [15:8] of audio group A channel status for channels 1 and 2.	R	0
249h	ACSR1_2A_BYTE 18_19	ACSR1_2A_18	15-0	Bytes 18 [7:0] and 19 [15:8] of audio group A channel status for channels 1 and 2.	R	0
24Ah	ACSR1_2A_BYTE 20_21	ACSR1_2A_20	15-0	Bytes 20 [7:0] and 21 [15:8] of audio group A channel status for channels 1 and 2.	R	0
24Bh	ACSR1_2A_BYTE 22	RSVD	15-8	Reserved.	R/W	0
		ACSR1_2A_22	7-0	Bytes 22 of audio group A channel status for channels 1 and 2.	R	0
24Ch - 24Fh	RSVD	RSVD	15-0	Reserved.	R/W	0
250h	ACSR3_4A_BYTE 0_1	ACSR3_4A_0	15-0	Bytes 0 [7:0] and 1 [15:8] of audio group A channel status for channels 3 and 4.	R	0
251h	ACSR3_4A_BYTE 2_3	ACSR3_4A_2	15-0	Bytes 2 [7:0] and 3 [15:8] of audio group A channel status for channels 3 and 4.	R	0
252h	ACSR3_4A_BYTE 4_5	ACSR3_4A_4	15-0	Bytes 4 [7:0] and 5 [15:8] of audio group A channel status for channels 3 and 4.	R	0
253h	ACSR3_4A_BYTE 6_7	ACSR3_4A_6	15-0	Bytes 6 [7:0] and 7 [15:8] of audio group A channel status for channels 3 and 4.	R	0
254h	ACSR3_4A_BYTE 8_9	ACSR3_4A_8	15-0	Bytes 8 [7:0] and 9 [15:8] of audio group A channel status for channels 3 and 4.	R	0
255h	ACSR3_4A_BYTE 10_11	ACSR3_4A_10	15-0	Bytes 10 [7:0] and 11 [15:8] of audio group A channel status for channels 3 and 4.	R	0
256h	ACSR3_4A_BYTE 12_13	ACSR3_4A_12	15-0	Bytes 12 [7:0] and 13 [15:8] of audio group A channel status for channels 3 and 4.	R	0
257h	ACSR3_4A_BYTE 14_15	ACSR3_4A_14	15-0	Bytes 14 [7:0] and 15 [15:8] of audio group A channel status for channels 3 and 4.	R	0

Table 4-30: HD Audio Core Configuration and Status Registers (Continued)

Address	Register Name	Bit Name	Bit	Description	R/W	Default
258h	ACSR3_4A_BYTE 16_17	ACSR3_4A_16	15-0	Bytes 16 [7:0] and 17 [15:8] of audio group A channel status for channels 3 and 4.	R	0
259h	ACSR3_4A_BYTE 18_19	ACSR3_4A_18	15-0	Bytes 18 [7:0] and 19 [15:8] of audio group A channel status for channels 3 and 4.	R	0
25Ah	ACSR3_4A_BYTE 20_21	ACSR3_4A_20	15-0	Bytes 20 [7:0] and 21 [15:8] of audio group A channel status for channels 3 and 4.	R	0
25Bh	ACSR3_4A_BYTE 22	RSVD	15-8	Reserved.	R/W	0
		ACSR3_4A_22	7-0	Bytes 22 of audio group A channel status for channels 3 and 4.	R	0
25Ch - 25Fh	RSVD	RSVD	15-0	Reserved.	R/W	0
260h	ACSR1_2B_BYTE 0_1	ACSR1_2B_0	15-0	Bytes 0 [7:0] and 1 [15:8] of audio group B channel status for channels 1 and 2.	R	0
261h	ACSR1_2B_BYTE 2_3	ACSR1_2B_2	15-0	Bytes 2 [7:0] and 3 [15:8] of audio group B channel status for channels 1 and 2.	R	0
262h	ACSR1_2B_BYTE 4_5	ACSR1_2B_4	15-0	Bytes 4 [7:0] and 5 [15:8] of audio group B channel status for channels 1 and 2.	R	0
263h	ACSR1_2B_BYTE 6_7	ACSR1_2B_6	15-0	Bytes 6 [7:0] and 7 [15:8] of audio group B channel status for channels 1 and 2.	R	0
264h	ACSR1_2B_BYTE 8_9	ACSR1_2B_8	15-0	Bytes 8 [7:0] and 9 [15:8] of audio group B channel status for channels 1 and 2.	R	0
265h	ACSR1_2B_BYTE 10_11	ACSR1_2B_10	15-0	Bytes 10 [7:0] and 11 [15:8] of audio group B channel status for channels 1 and 2.	R	0
266h	ACSR1_2B_BYTE 12_13	ACSR1_2B_12	15-0	Bytes 12 [7:0] and 13 [15:8] of audio group B channel status for channels 1 and 2.	R	0
267h	ACSR1_2B_BYTE 14_15	ACSR1_2B_14	15-0	Bytes 14 [7:0] and 15 [15:8] of audio group B channel status for channels 1 and 2.	R	0
268h	ACSR1_2B_BYTE 16_17	ACSR1_2B_16	15-0	Bytes 16 [7:0] and 17 [15:8] of audio group B channel status for channels 1 and 2.	R	0
269h	ACSR1_2B_BYTE 18_19	ACSR1_2B_18	15-0	Bytes 18 [7:0] and 19 [15:8] of audio group B channel status for channels 1 and 2.	R	0
26Ah	ACSR1_2B_BYTE 20_21	ACSR1_2B_20	15-0	Bytes 20 [7:0] and 21 [15:8] of audio group B channel status for channels 1 and 2.	R	0

Table 4-30: HD Audio Core Configuration and Status Registers (Continued)

Address	Register Name	Bit Name	Bit	Description	R/W	Default
26Bh	ACSR1_2B_BYTE 22	RSVD	15-8	Reserved.	R/W	0
		ACSR1_2B_22	7-0	Bytes 22 of audio group B channel status for channels 1 and 2.	R	0
26Ch - 26Fh	RSVD	RSVD	15-0	Reserved.	R/W	0
270h	ACSR3_4B_BYTE 0_1	ACSR3_4B_0	15-0	Bytes 0 [7:0] and 1 [15:8] of audio group B channel status for channels 3 and 4.	R	0
271h	ACSR3_4B_BYTE 2_3	ACSR3_4B_2	15-0	Bytes 2 [7:0] and 3 [15:8] of audio group B channel status for channels 3 and 4.	R	0
272h	ACSR3_4B_BYTE 4_5	ACSR3_4B_4	15-0	Bytes 4 [7:0] and 5 [15:8] of audio group B channel status for channels 3 and 4.	R	0
273h	ACSR3_4B_BYTE 6_7	ACSR3_4B_6	15-0	Bytes 6 [7:0] and 7 [15:8] of audio group B channel status for channels 3 and 4.	R	0
274h	ACSR3_4B_BYTE 8_9	ACSR3_4B_8	15-0	Bytes 8 [7:0] and 9 [15:8] of audio group B channel status for channels 3 and 4.	R	0
275h	ACSR3_4B_BYTE 10_11	ACSR3_4B_10	15-0	Bytes 10 [7:0] and 11 [15:8] of audio group B channel status for channels 3 and 4.	R	0
276h	ACSR3_4B_BYTE 12_13	ACSR3_4B_12	15-0	Bytes 12 [7:0] and 13 [15:8] of audio group B channel status for channels 3 and 4.	R	0
277h	ACSR3_4B_BYTE 14_15	ACSR3_4B_14	15-0	Bytes 14 [7:0] and 15 [15:8] of audio group B channel status for channels 3 and 4.	R	0
278h	ACSR3_4B_BYTE 16_17	ACSR3_4B_16	15-0	Bytes 16 [7:0] and 17 [15:8] of audio group B channel status for channels 3 and 4.	R	0
279h	ACSR3_4B_BYTE 18_19	ACSR3_4B_18	15-0	Bytes 18 [7:0] and 19 [15:8] of audio group B channel status for channels 3 and 4.	R	0
27Ah	ACSR3_4B_BYTE 20_21	ACSR3_4B_20	15-0	Bytes 20 [7:0] and 21 [15:8] of audio group B channel status for channels 3 and 4.	R	0
27Bh	ACSR3_4B_BYTE 22	RSVD	15-8	Reserved.	R/W	0
		ACSR3_4B_22	7-0	Bytes 22 of audio group B channel status for channels 3 and 4.	R	0
27Ch - 27Fh	RSVD	RSVD	15-0	Reserved.	R/W	0

Table 4-30: HD Audio Core Configuration and Status Registers (Continued)

Address	Register Name	Bit Name	Bit	Description	R/W	Default
280h	ACSR_BYTE_0	RSVD	15-8	Reserved.	R/W	0
		ACSR0	7-0	Audio channel status to use when ACS_REGEN is set or when adding audio channel status to non-AES/EBU audio. 8 bits per register starting at register 280h and ending at register 296h.	W	0
281h	ACSR_BYTE_1	RSVD	15-8	Reserved.	R/W	0
		ACSR1	7-0	Audio channel status to use when ACS_REGEN is set or when adding audio channel status to non-AES/EBU audio. 8 bits per register starting at register 280h and ending at register 296h.	W	0
282h	ACSR_BYTE_2	RSVD	15-8	Reserved.	R/W	0
		ACSR2	7-0	Audio channel status to use when ACS_REGEN is set or when adding audio channel status to non-AES/EBU audio. 8 bits per register starting at register 280h and ending at register 296h.	W	0
283h	ACSR_BYTE_3	RSVD	15-8	Reserved.	R/W	0
		ACSR3	7-0	Audio channel status to use when ACS_REGEN is set or when adding audio channel status to non-AES/EBU audio. 8 bits per register starting at register 280h and ending at register 296h.	W	0
284h	ACSR_BYTE_4	RSVD	15-8	Reserved.	R/W	0
		ACSR4	7-0	Audio channel status to use when ACS_REGEN is set or when adding audio channel status to non-AES/EBU audio. 8 bits per register starting at register 280h and ending at register 296h.	W	0
285h	ACSR_BYTE_5	RSVD	15-8	Reserved.	R/W	0
		ACSR5	7-0	Audio channel status to use when ACS_REGEN is set or when adding audio channel status to non-AES/EBU audio. 8 bits per register starting at register 280h and ending at register 296h.	W	0
286h	ACSR_BYTE_6	RSVD	15-8	Reserved.	R/W	0
		ACSR6	7-0	Audio channel status to use when ACS_REGEN is set or when adding audio channel status to non-AES/EBU audio. 8 bits per register starting at register 280h and ending at register 296h.	W	0

Table 4-30: HD Audio Core Configuration and Status Registers (Continued)

Address	Register Name	Bit Name	Bit	Description	R/W	Default
287h	ACSR_BYTE_7	RSVD	15-8	Reserved.	R/W	0
		ACSR7	7-0	Audio channel status to use when ACS_REGEN is set or when adding audio channel status to non-AES/EBU audio. 8 bits per register starting at register 280h and ending at register 296h.	W	0
288h	ACSR_BYTE_8	RSVD	15-8	Reserved.	R/W	0
		ACSR8	7-0	Audio channel status to use when ACS_REGEN is set or when adding audio channel status to non-AES/EBU audio. 8 bits per register starting at register 280h and ending at register 296h.	W	0
289h	ACSR_BYTE_9	RSVD	15-8	Reserved.	R/W	0
		ACSR9	7-0	Audio channel status to use when ACS_REGEN is set or when adding audio channel status to non-AES/EBU audio. 8 bits per register starting at register 280h and ending at register 296h.	W	0
28Ah	ACSR_BYTE_10	RSVD	15-8	Reserved.	R/W	0
		ACSR10	7-0	Audio channel status to use when ACS_REGEN is set or when adding audio channel status to non-AES/EBU audio. 8 bits per register starting at register 280h and ending at register 296h.	W	0
28Bh	ACSR_BYTE_11	RSVD	15-8	Reserved.	R/W	0
		ACSR11	7-0	Audio channel status to use when ACS_REGEN is set or when adding audio channel status to non-AES/EBU audio. 8 bits per register starting at register 280h and ending at register 296h.	W	0
28Ch	ACSR_BYTE_12	RSVD	15-8	Reserved.	R/W	0
		ACSR12	7-0	Audio channel status to use when ACS_REGEN is set or when adding audio channel status to non-AES/EBU audio. 8 bits per register starting at register 280h and ending at register 296h.	W	0
28Dh	ACSR_BYTE_13	RSVD	15-8	Reserved.	R/W	0
		ACSR13	7-0	Audio channel status to use when ACS_REGEN is set or when adding audio channel status to non-AES/EBU audio. 8 bits per register starting at register 280h and ending at register 296h.	W	0

Table 4-30: HD Audio Core Configuration and Status Registers (Continued)

Address	Register Name	Bit Name	Bit	Description	R/W	Default
28Eh	ACSR_BYTE_14	RSVD	15-8	Reserved.	R/W	0
		ACSR14	7-0	Audio channel status to use when ACS_REGEN is set or when adding audio channel status to non-AES/EBU audio. 8 bits per register starting at register 280h and ending at register 296h.	W	0
28Fh	ACSR_BYTE_15	RSVD	15-8	Reserved.	R/W	0
		ACSR15	7-0	Audio channel status to use when ACS_REGEN is set or when adding audio channel status to non-AES/EBU audio. 8 bits per register starting at register 280h and ending at register 296h.	W	0
290h	ACSR_BYTE_16	RSVD	15-8	Reserved.	R/W	0
		ACSR16	7-0	Audio channel status to use when ACS_REGEN is set or when adding audio channel status to non-AES/EBU audio. 8 bits per register starting at register 280h and ending at register 296h.	W	0
291h	ACSR_BYTE_17	RSVD	15-8	Reserved.	R/W	0
		ACSR17	7-0	Audio channel status to use when ACS_REGEN is set or when adding audio channel status to non-AES/EBU audio. 8 bits per register starting at register 280h and ending at register 296h.	W	0
292h	ACSR_BYTE_18	RSVD	15-8	Reserved.	R/W	0
		ACSR18	7-0	Audio channel status to use when ACS_REGEN is set or when adding audio channel status to non-AES/EBU audio. 8 bits per register starting at register 280h and ending at register 296h.	W	0
293h	ACSR_BYTE_19	RSVD	15-8	Reserved.	R/W	0
		ACSR19	7-0	Audio channel status to use when ACS_REGEN is set or when adding audio channel status to non-AES/EBU audio. 8 bits per register starting at register 280h and ending at register 296h.	W	0
294h	ACSR_BYTE_20	RSVD	15-8	Reserved.	R/W	0
		ACSR20	7-0	Audio channel status to use when ACS_REGEN is set or when adding audio channel status to non-AES/EBU audio. 8 bits per register starting at register 280h and ending at register 296h.	W	0

Table 4-30: HD Audio Core Configuration and Status Registers (Continued)

Address	Register Name	Bit Name	Bit	Description	R/W	Default
295h	ACSR_BYTE_21	RSVD	15-8	Reserved.	R/W	0
		ACSR21	7-0	Audio channel status to use when ACS_REGEN is set or when adding audio channel status to non-AES/EBU audio. 8 bits per register starting at register 280h and ending at register 296h.	W	0
296h	ACSR_BYTE_22	RSVD	15-8	Reserved.	R/W	0
		ACSR22	7-0	Audio channel status to use when ACS_REGEN is set or when adding audio channel status to non-AES/EBU audio. 8 bits per register starting at register 280h and ending at register 296h.	W	0
297h	RSVD	RSVD	15-0	Reserved.	R	29

Table 4-31: ANC Extraction FIFO Access Registers

Address	Register Name	Bit	Description	R/W	Default
800h - BFFh	ANC_PACKET_BANK	15-0	Extracted Ancillary Data 91024 words. Bit 15-8: Most Significant Word (MSW). Bit 7-0: Least Significant Word (LSW). See Section 4.17.8.	R	0

Legend:

R = Read only

ROCW = Read Only, Clear on Write

R/W = Read or Write

W = Write only

4.21 JTAG Test Operation

When the JTAG/ $\overline{\text{HOST}}$ pin of the GS1671 is set HIGH, the host interface port is configured for JTAG test operation. In this mode, pins E7, F8, F7, and E8 become TDO, TCK, TMS, and TDI. In addition, the $\overline{\text{RESET_TRST}}$ pin operates as the test reset pin.

Boundary scan testing using the JTAG interface is enabled in this mode.

There are two ways in which JTAG can be used:

1. As a stand-alone JTAG interface to be used at in-circuit ATE (Automatic Test Equipment) during PCB assembly.
2. Under control of a host processor for applications such as system power on self tests.

When the JTAG tests are applied by ATE, care must be taken to disable any other devices driving the digital I/O pins. If the tests are to be applied only at ATE, this can be

accomplished with tri-state buffers used in conjunction with the JTAG/ $\overline{\text{HOST}}$ input signal. This is shown in Figure 4-44.

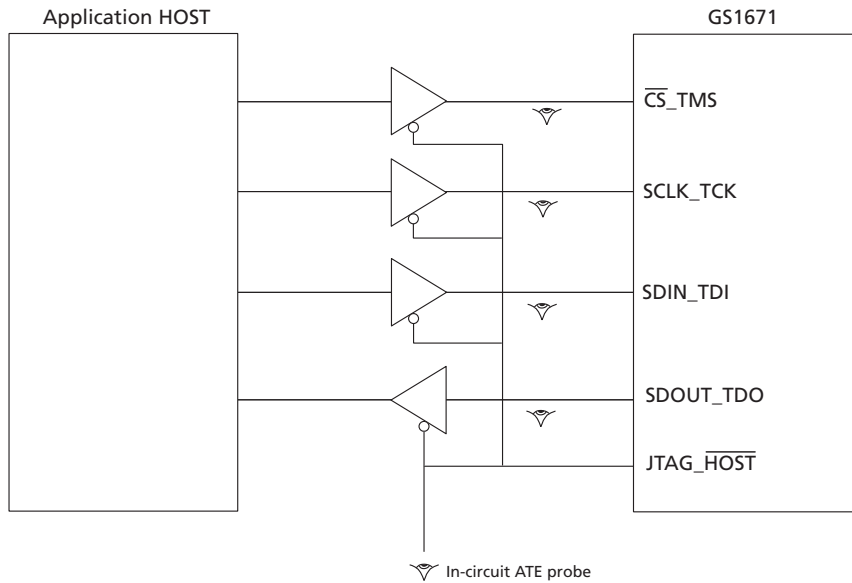

Figure 4-44: In-Circuit JTAG

Alternatively, if the test capabilities are to be used in the system, the host processor may still control the JTAG/ $\overline{\text{HOST}}$ input signal, but some means for tri-stating the host must exist in order to use the interface at ATE. This is represented in Figure 4-45.

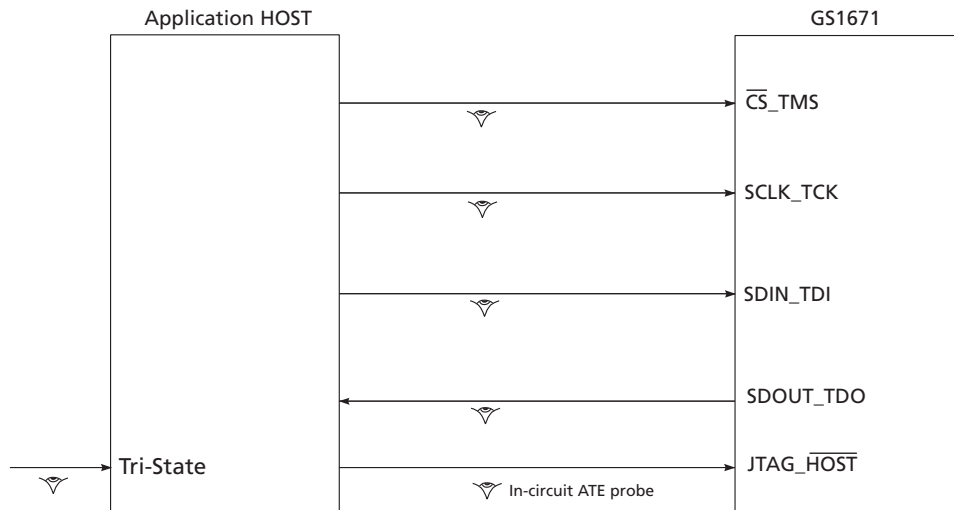

Figure 4-45: System JTAG

Scan coverage is limited to digital pins only. There is no scan coverage for analog pins VCO, SDO/ $\overline{\text{SDO}}$, RSET, LF, and CP_RES.

The JTAG/ $\overline{\text{HOST}}$ pin must be held LOW during scan and therefore has no scan coverage.

Please contact your Semtech representative to obtain the BSDL model for the GS1671.

4.22 Device Power-up

Because the GS1671 is designed to operate in a multi-voltage environment, any power-up sequence is allowed. The charge pump, phase detector, core logic, serial digital output and I/O buffers can all be powered up in any order.

4.23 Device Reset

NOTE: At power-up, the device must be reset to operate correctly.

In order to initialize all internal operating conditions to their default states, hold the $\overline{\text{RESET_TRST}}$ signal LOW for a minimum of $t_{\text{reset}} = 1\text{ms}$ after all power supplies are stable. There are no requirements for power supply sequencing.

When held in reset, all device outputs are driven to a high-impedance state.

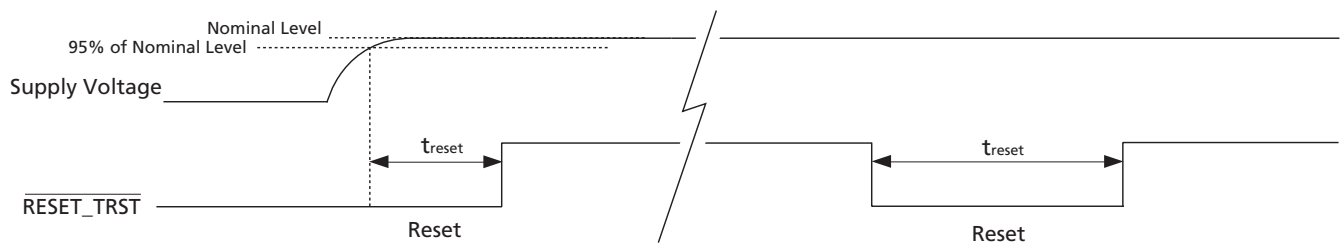

Figure 4-46: Reset Pulse

4.24 Standby Mode

The STANDBY pin reduces power to a minimum by disabling all circuits except for the register configuration. Upon removal of the signal to the STANDBY pin, the device returns to its previous operating condition within 1 second, without requiring input from the host interface.

5. Application Reference Design

5.1 High Gain Adaptive Cable Equalizers

The GS1671 has an integrated adaptive cable equalizer. In order to extend the cable length that an equalizer will remain operational at, it is necessary for the equalizer to have high gain.

A video cable equalizer must provide wide band gain over a range of frequencies in order to accommodate the range of data rates and signal patterns that are present in a SMPTE compliant serial video stream.

Small levels of signal or noise present at the input pins of the GS1671 may cause chatter at the output. In order to prevent this from happening, particular attention must be paid to board layout.

5.2 PCB Layout

Special attention must be paid to component layout when designing Serial Digital Interfaces for HDTV. An FR-4 dielectric can be used, however, controlled impedance transmission lines are required for PCB traces longer than approximately 1cm. Note the following PCB artwork features used to optimize performance:

- The PCB ground plane is removed under the GS1671 input components to minimize parasitic capacitance.
- High speed traces are curved to minimize impedance changes.

5.3 Typical Application Circuit

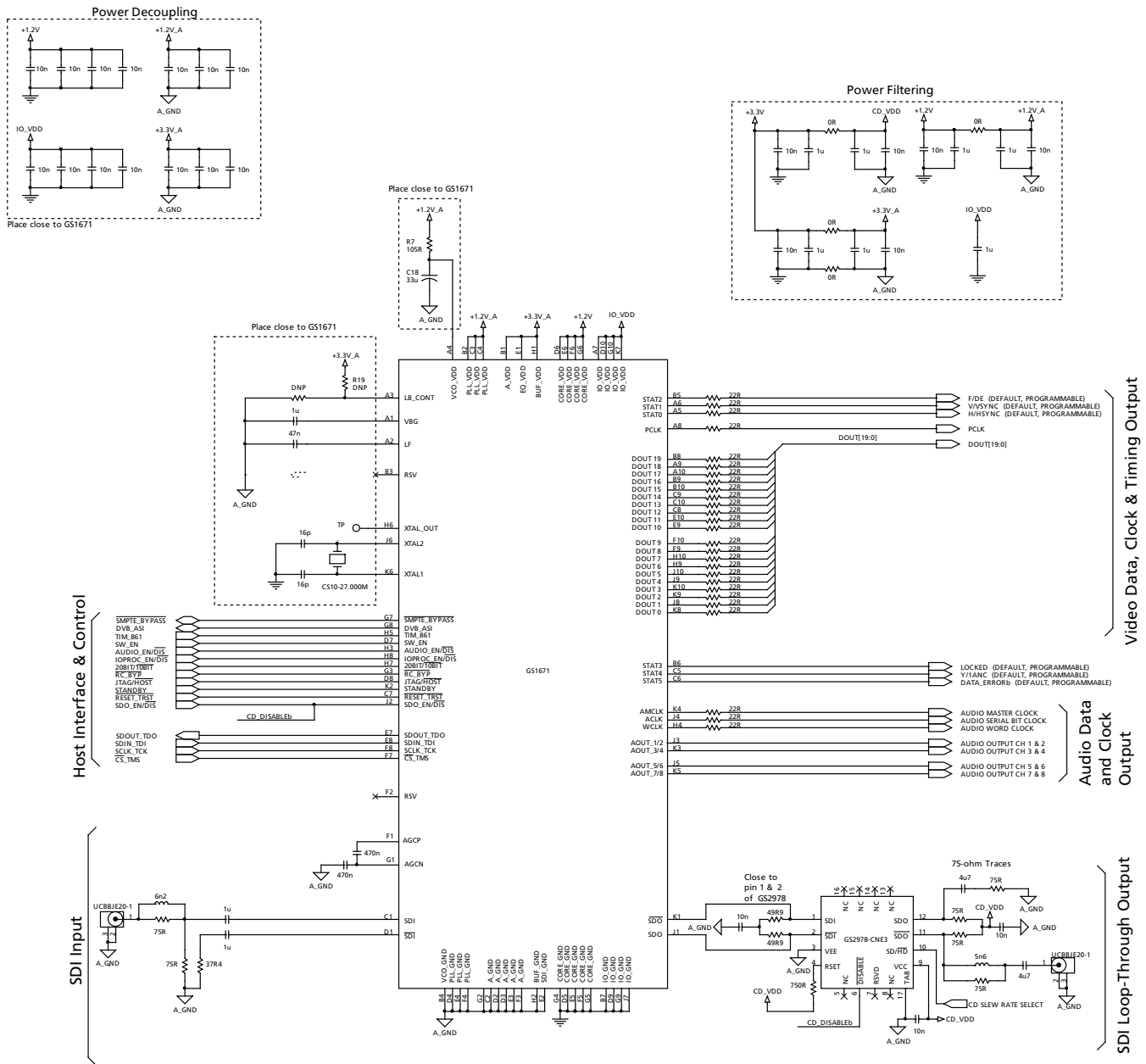

- Notes:
1. DNP (Do Not Populate).
 2. The value of the series resistors on video data, clock, and timing connections should be determined by board signal integrity test.
 3. For analog power and ground isolation, refer to PCB layout guide.
 4. For impedance controlled signal layout, refer to PCB layout guide.

6. References & Relevant Standards

SMPTE 125M	Component video signal 4:2:2 – bit parallel interface
SMPTE 259M	10-bit 4:2:2 Component and 4fsc Composite Digital Signals - Serial Digital Interface
SMPTE 260M	1125 / 60 high definition production system – digital representation and bit parallel interface
SMPTE 267M	Bit parallel digital interface – component video signal 4:2:2 16 x 9 aspect ratio
SMPTE 272M	Formatting AES/EBU Audio and Auxiliary Data into Digital Video Ancillary Data Space
SMPTE 274M	1920 x 1080 scanning analog and parallel digital interfaces for multiple picture rates
SMPTE 291M	Ancillary Data Packet and Space Formatting
SMPTE 292M	Bit-Serial Digital Interface for High-Definition Television Systems
SMPTE 293M	720 x 483 active line at 59.94Hz progressive scan production – digital representation
SMPTE 296M	1280 x 720 scanning, analog and digital representation and analog interface
SMPTE 299M	24-Bit Digital Audio Format for HDTV Bit-Serial Interface
SMPTE 305M	Serial Data Transport Interface
SMPTE 348M	High Data-Rate Serial Data Transport Interface (HD-SDTI)
SMPTE 352M	Video Payload Identification for Digital Television Interfaces
SMPTE 372M	Dual Link 292M Interface for 1920 x 1080 Picture Raster
SMPTE RP165	Error Detection Checkwords and Status Flags for Use in Bit-Serial Digital Interfaces for Television
SMPTE RP168	Definition of Vertical Interval Switching Point for Synchronous Video Switching
CEA 861	Video Timing Requirements

7. Package & Ordering Information

7.1 Package Dimensions

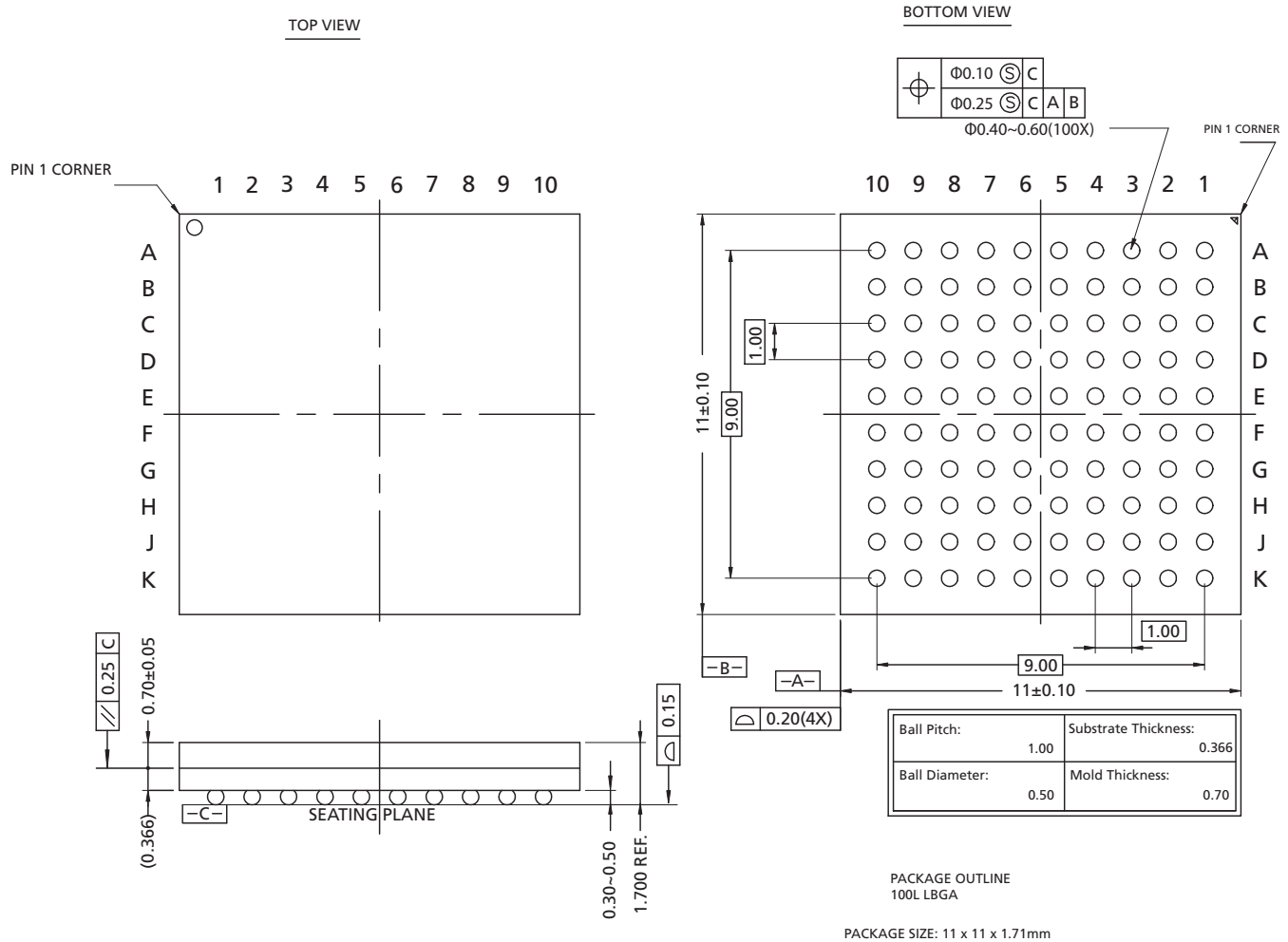

*THE BALL DIAMETER, BALL PITCH, STAND-OFF & PACKAGE THICKNESS ARE DIFFERENT FROM JEDEC SPEC M0192 (LOW PROFILE BGA FAMILY)

7.2 Packaging Data

Table 7-1:Packaging Data

Parameter	Value
Package Type	11mm x 11mm 100-ball LPGA
Package Drawing Reference	JEDEC M0192 (with exceptions noted in Package Dimensions on page 127).
Moisture Sensitivity Level	3
Junction to Case Thermal Resistance, θ_{j-c}	15.4°C/W
Junction to Air Thermal Resistance, θ_{j-a} (at zero airflow)	37.1°C/W
Junction to Board Thermal Resistance, θ_{j-b}	26.4°C/W
Psi, ψ	0.4°C/W
Pb-free and RoHS Compliant	Yes

7.3 Marking Diagram

Pin 1 ID

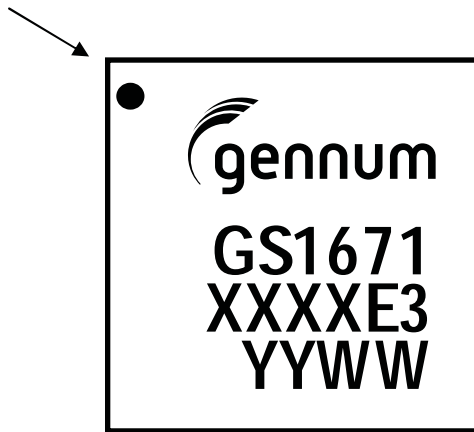

XXXX - Last 4 digits (excluding decimal) of SAP Batch Assembly (FIN) as listed on Packing Slip.
 E3 - Pb-free & Green indicator
 YYWW - Date Code

7.4 Solder Reflow Profiles

The GS1671 is available in a Pb-free package. It is recommended that the Pb-free package be soldered with Pb-free paste using the reflow profile shown in Figure 7-1.

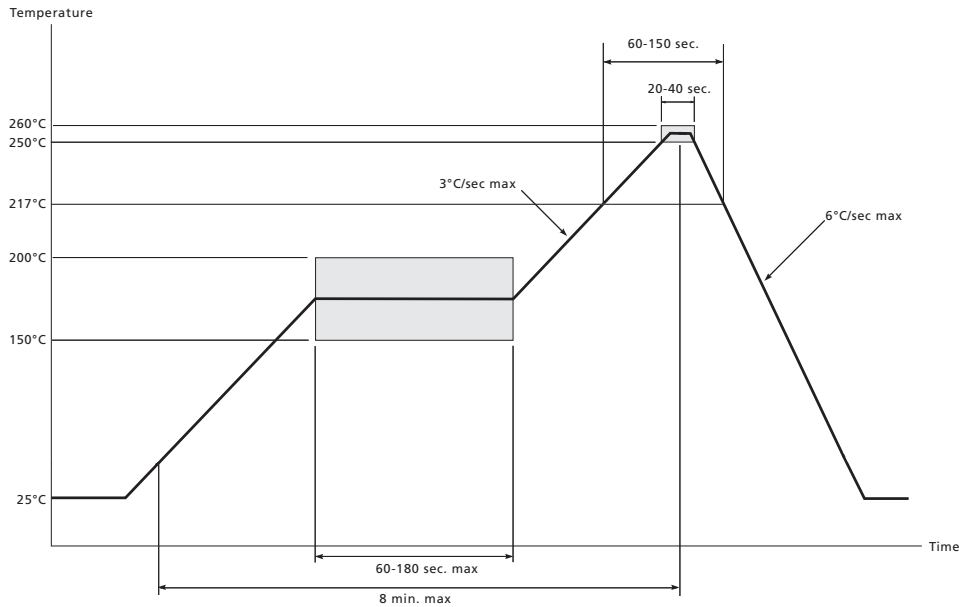

Figure 7-1:Pb-free Solder Reflow Profile

7.5 Ordering Information

Part Number	Package	Pb-free	Temperature Range
GS1671-IBE3	100-ball BGA	Yes	-20°C to 85°C

Revision History

Version	ECR	PCN	Date	Changes and/or Modifications
2	158468	–	September 2012	Changes throughout the document.
1	153472	–	January 2010	Converted to Data Sheet.
0	152961	–	November 2009	New Document. Added reference to GS1670/GS1671 Errata (document number 53878).



**DOCUMENT IDENTIFICATION
DATA SHEET**

Information relating to this product and the application or design described herein is believed to be reliable, however such information is provided as a guide only and Semtech assumes no liability for any errors in this document, or for the application or design described herein. Semtech reserves the right to make changes to the product or this document at any time without notice.

CAUTION

ELECTROSTATIC SENSITIVE DEVICES
DO NOT OPEN PACKAGES OR HANDLE EXCEPT AT A
STATIC-FREE WORKSTATION



© Semtech 2012

All rights reserved. Reproduction in whole or in part is prohibited without the prior written consent of the copyright owner. The information presented in this document does not form part of any quotation or contract, is believed to be accurate and reliable and may be changed without notice. No liability will be accepted by the publisher for any consequence of its use. Publication thereof does not convey nor imply any license under patent or other industrial or intellectual property rights. Semtech assumes no responsibility or liability whatsoever for any failure or unexpected operation resulting from misuse, neglect improper installation, repair or improper handling or unusual physical or electrical stress including, but not limited to, exposure to parameters beyond the specified maximum ratings or operation outside the specified range.

SEMTECH PRODUCTS ARE NOT DESIGNED, INTENDED, AUTHORIZED OR WARRANTED TO BE SUITABLE FOR USE IN LIFE-SUPPORT APPLICATIONS, DEVICES OR SYSTEMS OR OTHER CRITICAL APPLICATIONS. INCLUSION OF SEMTECH PRODUCTS IN SUCH APPLICATIONS IS UNDERSTOOD TO BE UNDERTAKEN SOLELY AT THE CUSTOMER'S OWN RISK. Should a customer purchase or use Semtech products for any such unauthorized application, the customer shall indemnify and hold Semtech and its officers, employees, subsidiaries, affiliates, and distributors harmless against all claims, costs damages and attorney fees which could arise.

Notice: All referenced brands, product names, service names and trademarks are the property of their respective owners.

Contact Information

Semtech Corporation
Gennum Products Division
200 Flynn Road, Camarillo, CA 93012
Phone: (805) 498-2111, Fax: (805) 498-3804
www.semtech.com