

BGM704N7

FM Radio LNA with Integrated RX/TX Switch

Data Sheet

Revision 2.1, 2010-10-19
Preliminary

Edition 2010-10-19

**Published by
Infineon Technologies AG
81726 Munich, Germany**

**© 2010 Infineon Technologies AG
All Rights Reserved.**

Legal Disclaimer

The information given in this document shall in no event be regarded as a guarantee of conditions or characteristics. With respect to any examples or hints given herein, any typical values stated herein and/or any information regarding the application of the device, Infineon Technologies hereby disclaims any and all warranties and liabilities of any kind, including without limitation, warranties of non-infringement of intellectual property rights of any third party.

Information

For further information on technology, delivery terms and conditions and prices, please contact the nearest Infineon Technologies Office (www.infineon.com).

Warnings

Due to technical requirements, components may contain dangerous substances. For information on the types in question, please contact the nearest Infineon Technologies Office.

Infineon Technologies components may be used in life-support devices or systems only with the express written approval of Infineon Technologies, if a failure of such components can reasonably be expected to cause the failure of that life-support device or system or to affect the safety or effectiveness of that device or system. Life support devices or systems are intended to be implanted in the human body or to support and/or maintain and sustain and/or protect human life. If they fail, it is reasonable to assume that the health of the user or other persons may be endangered.

BGM704N7 FM Radio LNA with Integrated RX/TX Switch

Revision History: 2010-10-19, Revision 2.1

Previous Revision: 2010-05-26, Revision 2.0

Page	Subjects (major changes since last revision)
12-23	Updated performance values

Trademarks of Infineon Technologies AG

AURIX™, BlueMoon™, COMNEON™, C166™, CROSSAVE™, CanPAK™, CIPOS™, CoolMOS™, CoolSET™, CORECONTROL™, DAVE™, EasyPIM™, EconoBRIDGE™, EconoDUAL™, EconoPACK™, EconoPIM™, EiceDRIVER™, EUPEC™, FCOS™, HITFET™, HybridPACK™, ISOFACE™, I²RF™, IsoPACK™, MIPAQ™, ModSTACK™, my-d™, NovalithIC™, OmniTune™, OptiMOS™, ORIGA™, PROFET™, PRO-SIL™, PRIMARION™, PrimePACK™, RASIC™, ReverSave™, SatRIC™, SIEGET™, SINDRION™, SMARTi™, SmartLEWIS™, TEMPFET™, thinQ!™, TriCore™, TRENCHSTOP™, X-GOLD™, XMM™, X-PMU™, XPOSYS™.

Other Trademarks

Advance Design System™ (ADS) of Agilent Technologies, AMBA™, ARM™, MULTI-ICE™, PRIMECELL™, REALVIEW™, THUMB™ of ARM Limited, UK. AUTOSAR™ is licensed by AUTOSAR development partnership. Bluetooth™ of Bluetooth SIG Inc. CAT-iq™ of DECT Forum. COLOSSUS™, FirstGPS™ of Trimble Navigation Ltd. EMV™ of EMVCo, LLC (Visa Holdings Inc.). EPCOS™ of Epcos AG. FLEXGO™ of Microsoft Corporation. FlexRay™ is licensed by FlexRay Consortium. HYPERTERMINAL™ of Hilgraeve Incorporated. IEC™ of Commission Electrotechnique Internationale. IrDA™ of Infrared Data Association Corporation. ISO™ of INTERNATIONAL ORGANIZATION FOR STANDARDIZATION. MATLAB™ of MathWorks, Inc. MAXIM™ of Maxim Integrated Products, Inc. MICROTEC™, NUCLEUS™ of Mentor Graphics Corporation. Mifare™ of NXP. MIPI™ of MIPI Alliance, Inc. MIPS™ of MIPS Technologies, Inc., USA. muRata™ of MURATA MANUFACTURING CO., MICROWAVE OFFICE™ (MWO) of Applied Wave Research Inc., OmniVision™ of OmniVision Technologies, Inc. Openwave™ Openwave Systems Inc. RED HAT™ Red Hat, Inc. RFMD™ RF Micro Devices, Inc. SIRIUS™ of Sirius Sattelite Radio Inc. SOLARIS™ of Sun Microsystems, Inc. SPANSION™ of Spansion LLC Ltd. Symbian™ of Symbian Software Limited. TAIYO YUDEN™ of Taiyo Yuden Co. TEAKLITE™ of CEVA, Inc. TEKTRONIX™ of Tektronix Inc. TOKO™ of TOKO KABUSHIKI KAISHA TA. UNIX™ of X/Open Company Limited. VERILOG™, PALLADIUM™ of Cadence Design Systems, Inc. VLYNQ™ of Texas Instruments Incorporated. VXWORKS™, WIND RIVER™ of WIND RIVER SYSTEMS, INC. ZETEX™ of Diodes Zetex Limited.

Last Trademarks Update 2010-06-09

Table of Contents

	Table of Contents	4
	List of Figures	5
	List of Tables	6
1	Features	7
2	Electrical Characteristics	9
2.1	Absolute Maximum Ratings	9
2.2	Thermal Resistance	9
2.3	ESD Integrity	9
2.4	DC Characteristics	10
2.5	RX/TX Control Truth Table	10
2.6	Logic Signal Characteristics	11
2.7	Switching Times	11
2.8	Measured RF Characteristics RX Mode in 50 Ω System, $V_{CC} = 1.8\text{ V}$	12
2.9	Measured RF Characteristics RX Mode in 50 Ω System, $V_{CC} = 3.0\text{ V}$	13
2.10	Measured RF Characteristics TX Mode in 50 Ω System, $V_{CC} = 1.8\text{ V}$	14
2.11	Measured RF Characteristics TX Mode in 50 Ω System, $V_{CC} = 3.0\text{ V}$	15
2.12	Measured RF Characteristics RX Mode (ANT 5 k Ω -> RX 50 Ω), $V_{CC} = 3.0\text{ V}$	16
2.13	Measured Performance RX Mode in 50 Ω System vs. Frequency	17
2.14	Measured Performance RX Mode in 50 Ω System vs. Temperature	19
2.15	Measured Performance RX Mode in 50 Ω System vs. Voltage	20
2.16	Measured Performance TX Mode in 50 Ω System vs. Frequency	21
2.17	Measured Performance TX Mode in 50 Ω System vs. Temperature	22
2.18	Measured Performance TX Mode in 50 Ω System vs. Voltage	23
3	Application Circuit and Block Diagram	24
3.1	FM Radio in 50 Ω System Application Circuit Schematic	24
3.2	FM Radio in High Ohmic System Application Circuit Schematic	25
3.3	Pin Description	26
3.4	Application Board	27
4	Physical Characteristics	29
4.1	Package Footprint	29
4.2	Package Dimensions	30

List of Figures

Figure 1	Block Diagram of FM Radio Module	8
Figure 2	Application Circuit with Chip Outline (Top View)	24
Figure 3	Application Circuit with Chip Outline High Ohmic (Top View).	25
Figure 4	Application Board Layout on 3-layer FR4.	27
Figure 5	Cross-Section View of Application Board	27
Figure 6	Detail of Application Board Layout	28
Figure 7	Recommended Footprint and Stencil Layout for the TSNP-7-1 Package	29
Figure 8	Package Outline (Top, Side and Bottom View)	30

List of Tables

Table 1	Absolute Maximum Ratings	9
Table 2	Thermal Resistance	9
Table 3	ESD Integrity	9
Table 4	DC Characteristics, $T_A = 25\text{ }^\circ\text{C}$	10
Table 5	Band Select Truth Table	10
Table 6	Typical Switching Times; $T_A = -30 \dots 85\text{ }^\circ\text{C}$	11
Table 7	Typical Characteristics 100 MHz, $T_A = 25\text{ }^\circ\text{C}$, $V_{CC} = 1.8\text{ V}$, $V_{ON} = 1.8\text{ V}$, $V_{MODE} = 1.8\text{ V}$	12
Table 8	Typical Characteristics 100 MHz, $T_A = 25\text{ }^\circ\text{C}$, $V_{CC} = 3.0\text{ V}$, $V_{ON} = 3.0\text{ V}$, $V_{MODE} = 3.0\text{ V}$	13
Table 9	Typical Characteristics 100 MHz, $T_A = 25\text{ }^\circ\text{C}$, $V_{CC} = 1.8\text{ V}$, $V_{ON} = 1.8\text{ V}$, $V_{MODE} = 0\text{ V}$	14
Table 10	Typical Characteristics 100 MHz, $T_A = 25\text{ }^\circ\text{C}$, $V_{CC} = 3.0\text{ V}$, $V_{ON} = 3.0\text{ V}$, $V_{MODE} = 0\text{ V}$	15
Table 11	Typical Characteristics 100 MHz, $T_A = 25\text{ }^\circ\text{C}$, $V_{CC} = 3.0\text{ V}$, $V_{ON} = 3.0\text{ V}$, $V_{MODE} = 3.0\text{ V}$	16
Table 12	Bill of Materials 50 Ω Application	24
Table 13	Bill of Materials High Ohmic Antenna Application	25
Table 14	Pin Definition and Function	26

1 Features

Main features:

- High performance FM radio LNA with integrated biasing and RX/TX switch
- Worldwide FM band support (76-108 MHz)
- Designed for high ohmic antenna
- 2kV HBM ESD protection
- Very high gain at low current consumption
- High input compression point
- Integrated active biasing circuit enables stable operation point against temperature and process-variation
- Operation voltage: 1.8 V to 3.6 V
- Standby mode
- Very small and leadless package TSNP-7-1, 2.0 x 1.3 x 0.4 mm
- Pb-free (RoHS compliant) and halogen-free (WEEE compliant) package

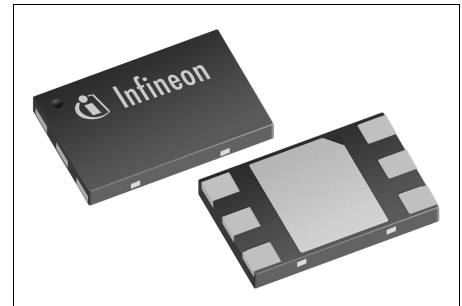

Description

The BGM704N7 is a high performance Silicon Germanium Carbon (SiGe:C) FM radio LNA with integrated RX/TX switch and active biasing in a very small TSNP-7-1 package for use in FM radio systems.

Product Name	Package	Chip	Marking
BGM704N7	TSNP-7-1	T1585	tbd

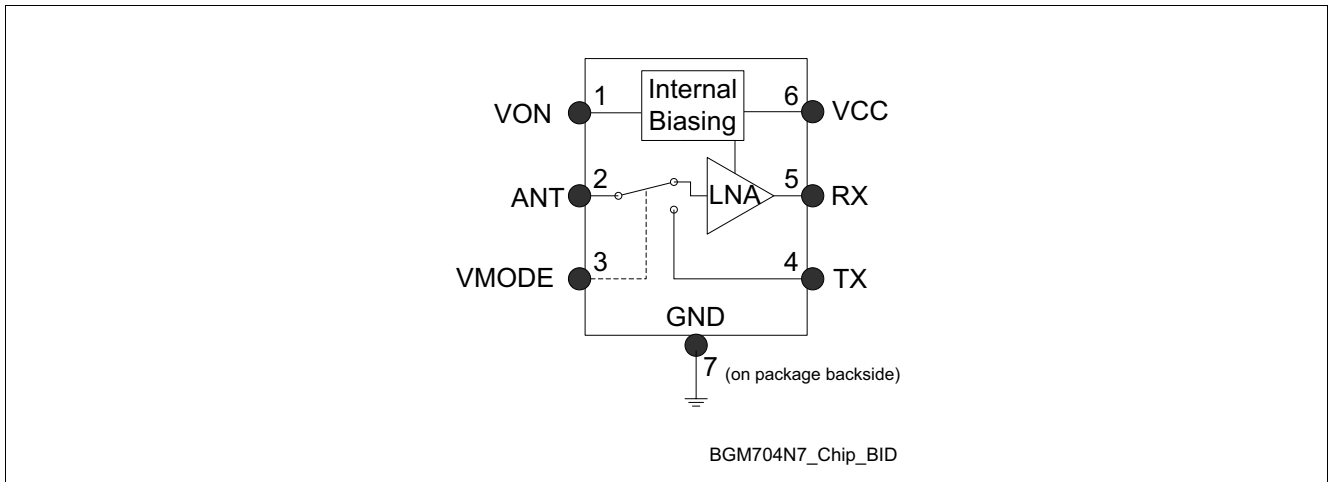

Figure 1 Block Diagram of FM Radio Module

2 Electrical Characteristics

2.1 Absolute Maximum Ratings

Table 1 Absolute Maximum Ratings

Parameter	Symbol	Values			Unit	Note / Test Condition
		Min.	Typ.	Max.		
Supply voltage	V_{CC}	-0.3	–	3.6	V	–
Supply current	I_{CC}	–	–	25	mA	–
Control voltage	V_{MODE}	-0.3	–	$V_{CC} + 0.3$	V	–
On / Off voltage	V_{ON}	-0.3	–	$V_{CC} + 0.3$	V	–
Pin voltage ANT Pin	V_{RFIN}	-0.3	–	0.9	V	–
RF input power	P_{RFIN}	–	–	tbd	dBm	–
Junction temperature	T_j	–	–	150	°C	–
Ambient temperature range	T_A	-30	–	85	°C	–
Storage temperature range	T_{stg}	-65	–	150	°C	–

Attention: Stresses above the max. values listed here may cause permanent damage to the device. Exposure to absolute maximum rating conditions for extended periods may affect device reliability. Maximum ratings are absolute ratings; exceeding only one of these values may cause irreversible damage to the integrated circuit.

2.2 Thermal Resistance

Table 2 Thermal Resistance

Parameter	Symbol	Values			Unit	Note / Test Condition
		Min.	Typ.	Max.		
Thermal resistance junction to soldering point	R_{thJS}	–	–	tbd	K/W	–

2.3 ESD Integrity

Table 3 ESD Integrity

Parameter	Symbol	Values			Unit	Note / Test Condition
		Min.	Typ.	Max.		
ESD hardness HBM ¹⁾	$V_{ESD-HBM}$	–	2000	–	V	All pins

1) According to JESD22-A114

2.4 DC Characteristics

Table 4 DC Characteristics, $T_A = 25\text{ °C}$

Parameter	Symbol	Values			Unit	Note / Test Condition
		Min.	Typ.	Max.		
Supply voltage	V_{CC}	1.8	3.0	3.6	V	–
Supply current RX mode	I_{CC}	–	3.6	–	mA	–
Supply current TX mode	I_{CC}	–	0.4	–	mA	–
Supply current standby mode	I_{CCOFF}	–	0.1	2	μ A	–
Logic level high	V_{HI}	1.5	3.0	–	V	All logic pins
Logic level low	V_{LO}	–	0.0	0.5	V	
Logic currents	I_{LO}	–	0.1	–	μ A	All logic pins
	I_{HI}	–	5.0	–	μ A	

2.5 RX/TX Control Truth Table

Table 5 Band Select Truth Table

	RX Mode	TX Mode	Standby
VON	H	H	L
VMODE	H	L	x

2.6 Logic Signal Characteristics

Current consumption of logic inputs VON, VMODE

Logic currents $I_{ON} = f(V_{ON})$
 $V_{CC} = 3.0\text{ V}$, $T_A = 25\text{ °C}$

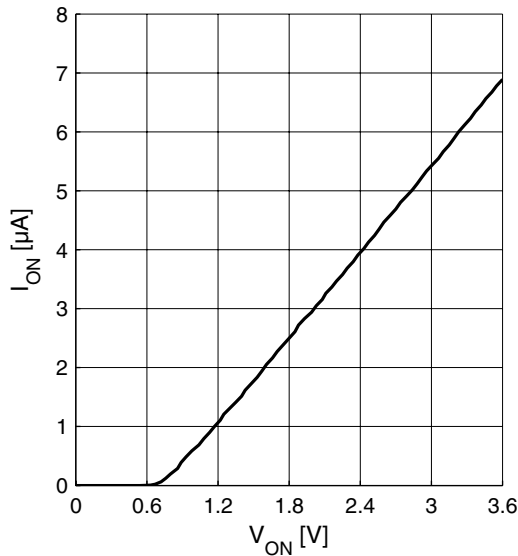

Logic currents $I_{MODE} = f(V_{MODE})$
 $V_{CC} = 3.0\text{ V}$, $T_A = 25\text{ °C}$

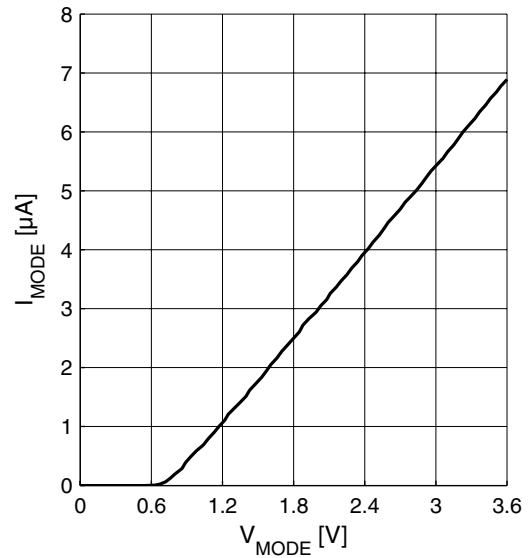

2.7 Switching Times

Table 6 Typical Switching Times; $T_A = -30 \dots 85\text{ °C}$

Parameter	Symbol	Values			Unit	Note / Test Condition
		Min.	Typ.	Max.		
Control settling time	t_{MODE}	–	3	–	µs	Switching RX ↔ TX (pin VMODE)
Power on settling time	t_{ON}	–	5	–	µs	Switching from standby mode to ON mode (pin VON)

2.8 Measured RF Characteristics RX Mode in 50 Ω System, $V_{CC} = 1.8\text{ V}$

Table 7 Typical Characteristics 100 MHz, $T_A = 25\text{ °C}$, $V_{CC} = 1.8\text{ V}$, $V_{ON} = 1.8\text{ V}$, $V_{MODE} = 1.8\text{ V}^1)$

Parameter	Symbol	Values			Unit	Note / Test Condition
		Min.	Typ.	Max.		
Pass band range		76	–	108	MHz	–
Current consumption	I_{CC}	–	3.3	–	mA	–
Gain	S_{21}	–	12.0	–	dB	–
Reverse Isolation ²⁾	S_{12}	–	-54	–	dB	–
Noise figure	NF	–	3.5	–	dB	–
Input return loss ²⁾	S_{11}	–	-0.6	–	dB	50 Ω
Output return loss ²⁾	S_{22}	–	-14	–	dB	50 Ω
Stability factor ³⁾	k	–	>2.9	–	–	DC to 8 GHz
Input compression point ²⁾	IP_{1dB}	–	-9	–	dBm	–
Inband IIP3 ²⁾ $f_1 - f_2 = 1\text{ MHz}$	$IIP3$	–	-13	–	dBm	–

1) Performance based on application circuit in Figure 2 on Page 24

2) Verification based on AQL; random production test

3) Guaranteed by device design; not tested in production

2.9 Measured RF Characteristics RX Mode in 50 Ω System, $V_{CC} = 3.0\text{ V}$

Table 8 Typical Characteristics 100 MHz, $T_A = 25\text{ °C}$, $V_{CC} = 3.0\text{ V}$, $V_{ON} = 3.0\text{ V}$, $V_{MODE} = 3.0\text{ V}^1)$

Parameter	Symbol	Values			Unit	Note / Test Condition
		Min.	Typ.	Max.		
Pass band range		76	–	108	MHz	–
Current consumption	I_{CC}	–	3.6	–	mA	–
Gain	S_{21}	–	12.5	–	dB	–
Reverse Isolation ²⁾	S_{12}	–	-55	–	dB	–
Noise figure	NF	–	2.9	–	dB	–
Input return loss ²⁾	S_{11}	–	-0.6	–	dB	50 Ω
Output return loss ²⁾	S_{22}	–	-14	–	dB	50 Ω
Stability factor ³⁾	k	–	>2.4	–	–	DC to 8 GHz
Input compression point ²⁾	IP_{1dB}	–	-7	–	dBm	–
Inband IIP3 ²⁾ $f_1 - f_2 = 1\text{ MHz}$	$IIP3$	–	-14	–	dBm	–

1) Performance based on application circuit in Figure 2 on Page 24

2) Verification based on AQL; random production test

3) Guaranteed by device design; not tested in production

2.10 Measured RF Characteristics TX Mode in 50 Ω System, $V_{CC} = 1.8\text{ V}$

Table 9 Typical Characteristics 100 MHz, $T_A = 25\text{ °C}$, $V_{CC} = 1.8\text{ V}$, $V_{ON} = 1.8\text{ V}$, $V_{MODE} = 0\text{ V}$ ¹⁾

Parameter	Symbol	Values			Unit	Note / Test Condition
		Min.	Typ.	Max.		
Pass band range		76	–	108	MHz	–
Current consumption	I_{CC}	–	0.30	–	mA	–
Gain	S_{21}	–	-2.5	–	dB	–
Reverse Isolation ²⁾	S_{12}	–	-2.5	–	dB	–
Input return loss ²⁾	S_{11}	–	-12	–	dB	50 Ω
Output return loss ²⁾	S_{22}	–	-12	–	dB	50 Ω
Stability factor ³⁾	k	–	>1	–	–	DC to 8 GHz
Input compression point ²⁾	IP_{1dB}	–	6	–	dBm	–
Inband IIP3 ²⁾ $f_1 - f_2 = 1\text{ MHz}$	$IIP3$	–	9	–	dBm	–

1) Performance based on application circuit in Figure 2 on Page 24

2) Verification based on AQL; random production test

3) Guaranteed by device design; not tested in production

2.11 Measured RF Characteristics TX Mode in 50 Ω System, $V_{CC} = 3.0\text{ V}$

Table 10 Typical Characteristics 100 MHz, $T_A = 25\text{ °C}$, $V_{CC} = 3.0\text{ V}$, $V_{ON} = 3.0\text{ V}$, $V_{MODE} = 0\text{ V}$ ¹⁾

Parameter	Symbol	Values			Unit	Note / Test Condition
		Min.	Typ.	Max.		
Pass band range		76	–	108	MHz	–
Current consumption	I_{CC}	–	0.40	–	mA	–
Gain	S_{21}	–	-1.6	–	dB	–
Reverse Isolation ²⁾	S_{12}	–	-1.6	–	dB	–
Input return loss ²⁾	S_{11}	–	-14	–	dB	50 Ω
Output return loss ²⁾	S_{22}	–	-14	–	dB	50 Ω
Stability factor ³⁾	k	–	>1	–	–	DC to 8 GHz
Input compression point ²⁾	IP_{1dB}	–	10	–	dBm	–
Inband IIP3 ²⁾ $f_1 - f_2 = 1\text{ MHz}$	$IIP3$	–	15	–	dBm	–

1) Performance based on application circuit in Figure 2 on Page 24

2) Verification based on AQL; random production test

3) Guaranteed by device design; not tested in production

2.12 Measured RF Characteristics RX Mode (ANT 5 kΩ -> RX 50 Ω), $V_{CC} = 3.0\text{ V}$

Table 11 Typical Characteristics 100 MHz, $T_A = 25\text{ °C}$, $V_{CC} = 3.0\text{ V}$, $V_{ON} = 3.0\text{ V}$, $V_{MODE} = 3.0\text{ V}^1)$

Parameter	Symbol	Values			Unit	Note / Test Condition
		Min.	Typ.	Max.		
Pass band range		76	–	108	MHz	–
Current consumption	I_{CC}	–	3.6	–	mA	–
Transducer gain ²⁾	S_{21}	–	20.0	–	dB	$Z_S = 5\text{ k}\Omega$ $Z_L = 50\ \Omega$
Noise figure ²⁾	NF	–	5.5	–	dB	$Z_S = 5\text{ k}\Omega$ $Z_L = 50\ \Omega$

1) Performance based on application circuit in Figure 3 on Page 25

2) Guaranteed by device design; not tested in production

2.13 Measured Performance RX Mode in 50 Ω System vs. Frequency

$T_A = 25\text{ °C}$, $V_{CC} = 3.0\text{ V}$, $V_{ON} = 3.0\text{ V}$, $V_{MODE} = 3.0\text{ V}$

Power Gain $|S_{21}| = f(f)$

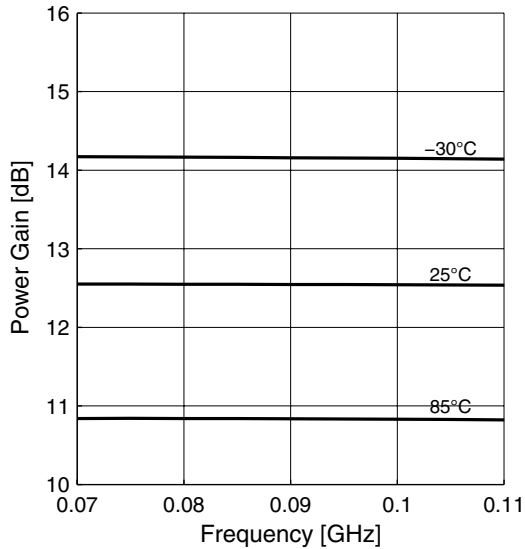

Power Gain wideband $|S_{21}| = f(f)$

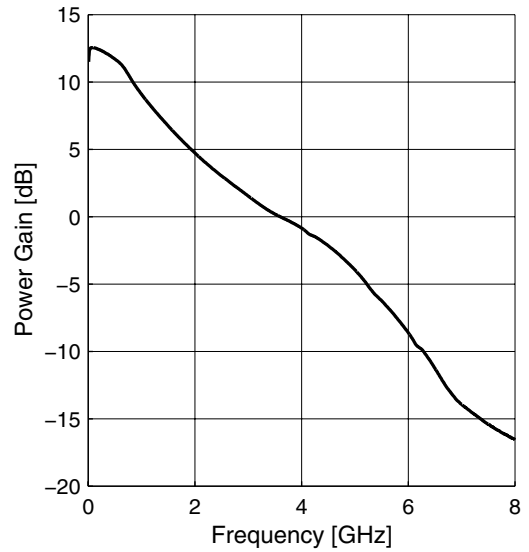

Matching $|S_{11}| = f(f)$, $|S_{22}| = f(f)$

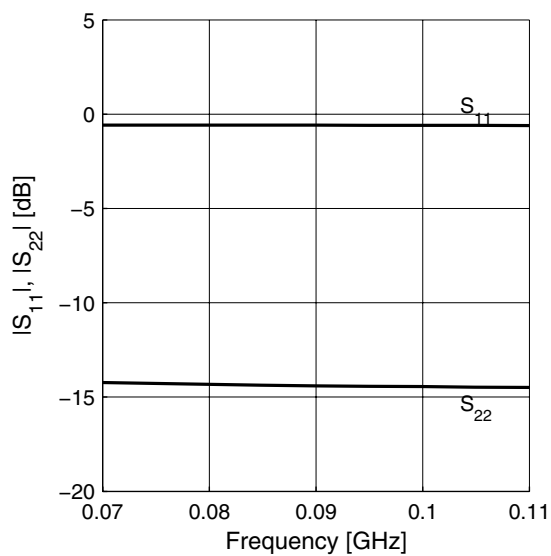

Noise Figure $NF = f(f)$

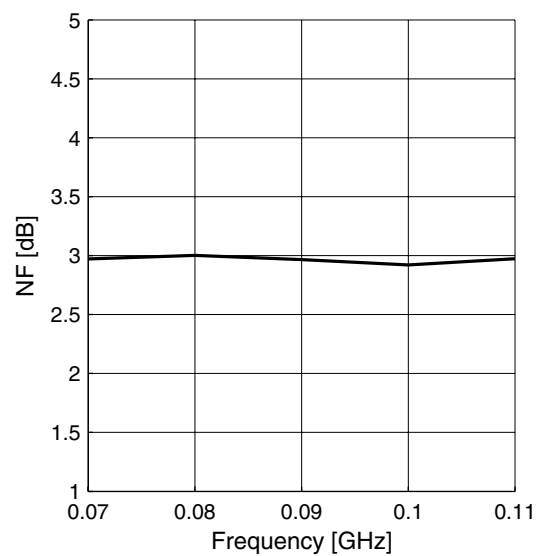

Input Compression $P1dB = f(f)$

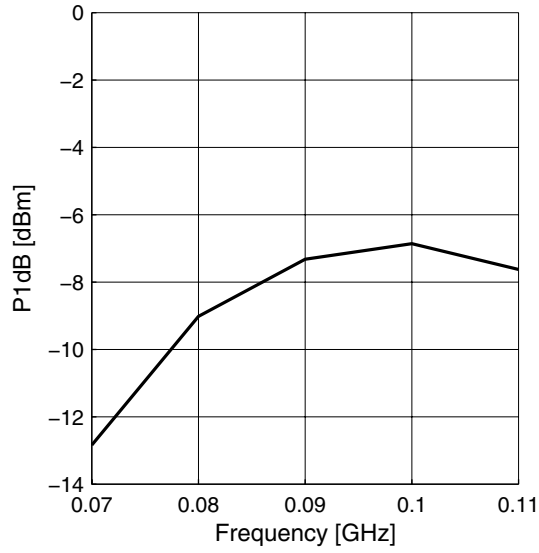

2.14 Measured Performance RX Mode in 50 Ω System vs. Temperature

$V_{CC} = 3.0\text{ V}$, $V_{ON} = 3.0\text{ V}$, $V_{MODE} = 3.0\text{ V}$, $f = 100\text{ MHz}$

Power Gain $|S_{21}| = f(T_A)$

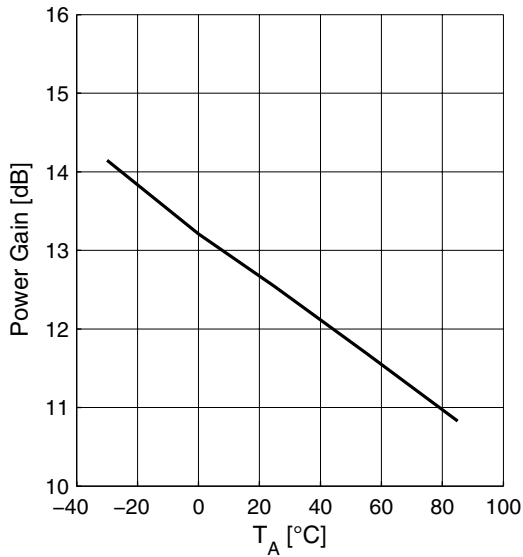

Supply Current $I_{CC} = f(T_A)$

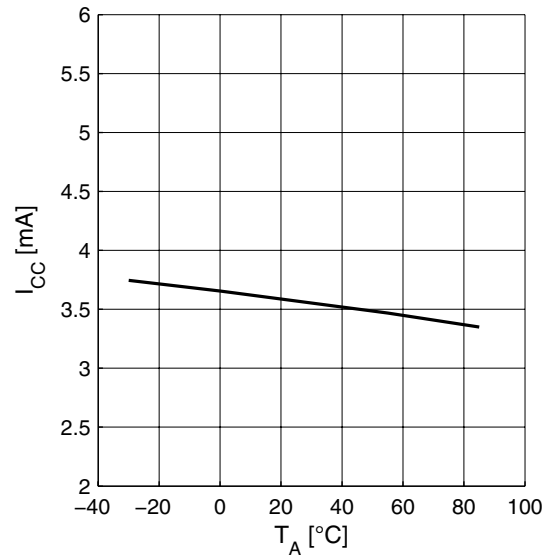

Noise Figure $NF = f(T_A)$

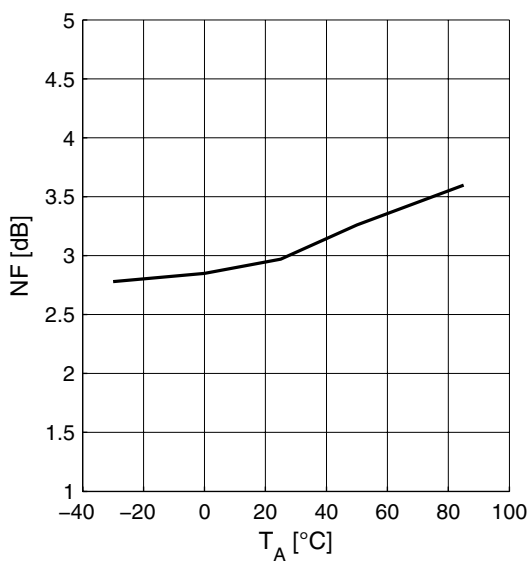

Input Compression $P1dB = f(T_A)$

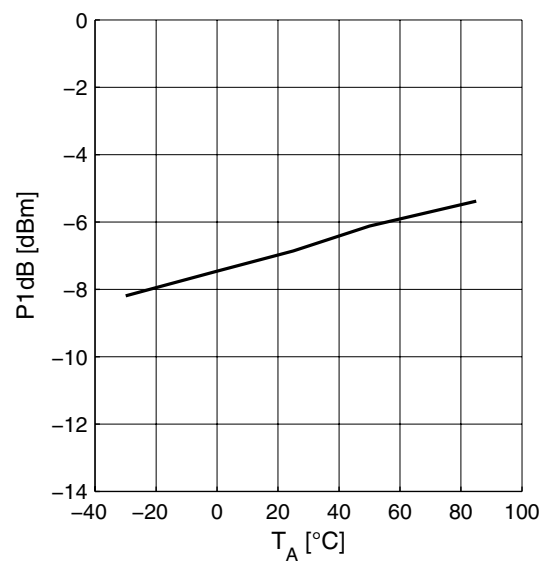

2.15 Measured Performance RX Mode in 50 Ω System vs. Voltage

$V_{CC} = 3.0\text{ V}$, $V_{ON} = 3.0\text{ V}$, $V_{MODE} = 3.0\text{ V}$, $f = 100\text{ MHz}$

Power Gain $|S_{21}| = f(V)$

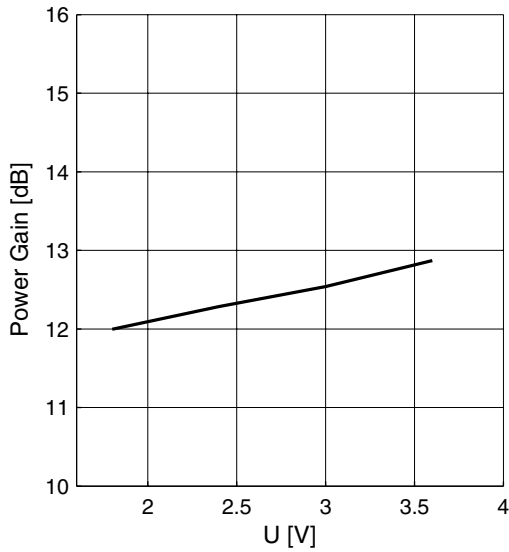

Supply Current $I_{CC} = f(V)$

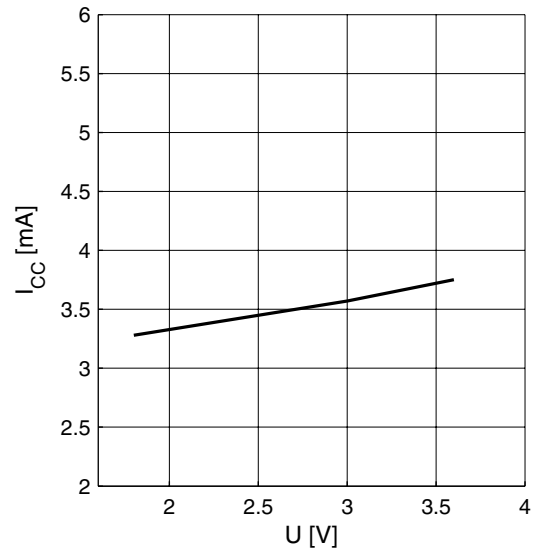

Noise Figure $NF = f(V)$

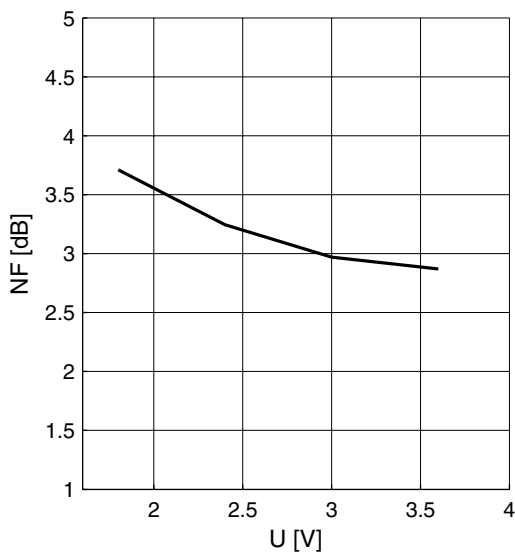

Input Compression $P1dB = f(V)$

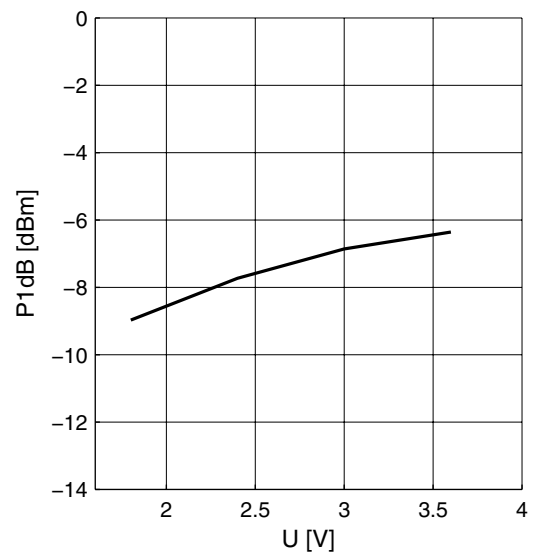

2.16 Measured Performance TX Mode in 50 Ω System vs. Frequency

$T_A = 25\text{ }^\circ\text{C}$, $V_{CC} = 3.0\text{ V}$, $V_{ON} = 3.0\text{ V}$, $V_{MODE} = 0\text{ V}$

Power Gain $|S_{21}| = f(f)$

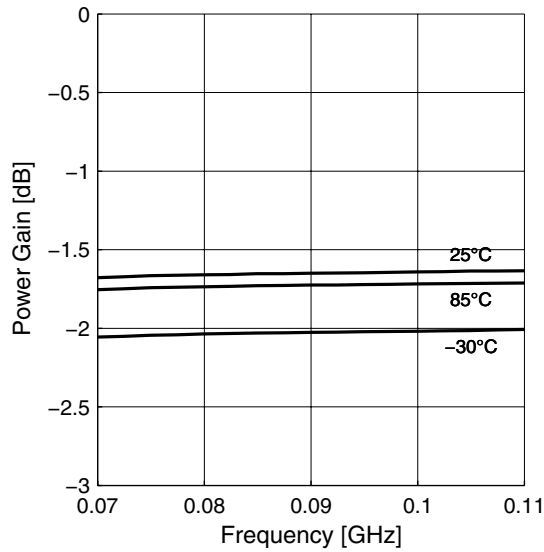

Power Gain wideband $|S_{21}| = f(f)$

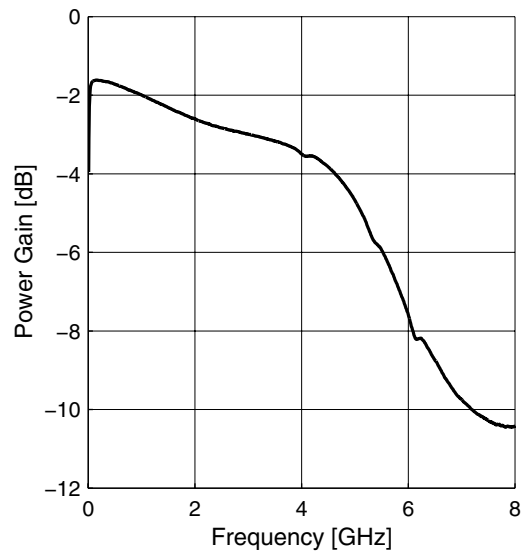

Matching $|S_{11}| = f(f)$, $|S_{22}| = f(f)$

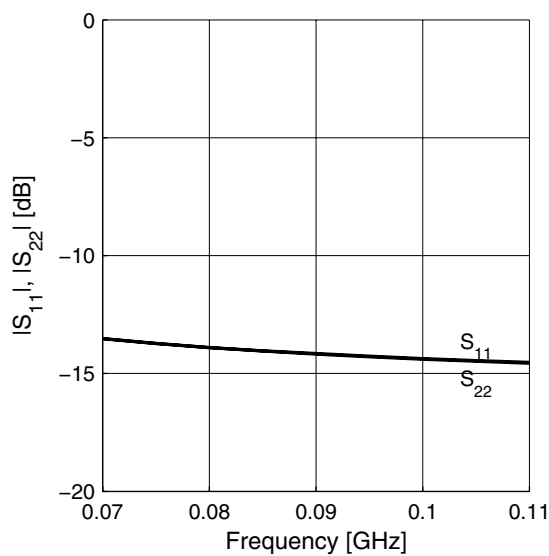

Input Compression $P1dB = f(f)$

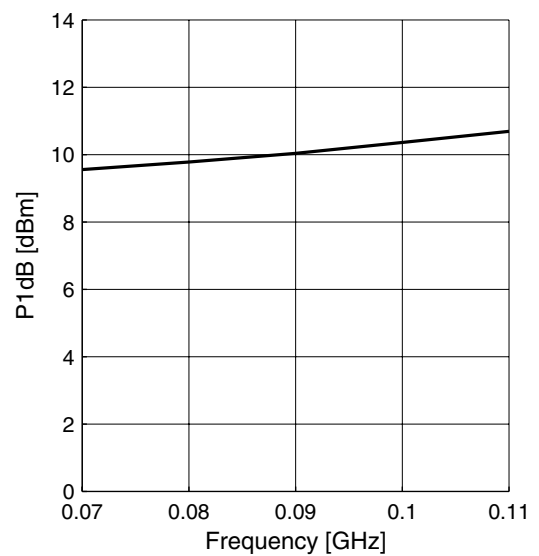

2.17 Measured Performance TX Mode in 50 Ω System vs. Temperature

$V_{CC} = 3\text{ V}$, $V_{ON} = 3\text{ V}$, $V_{MODE} = 0\text{ V}$, $f = 100\text{ MHz}$

Power Gain $|S_{21}| = f(T_A)$

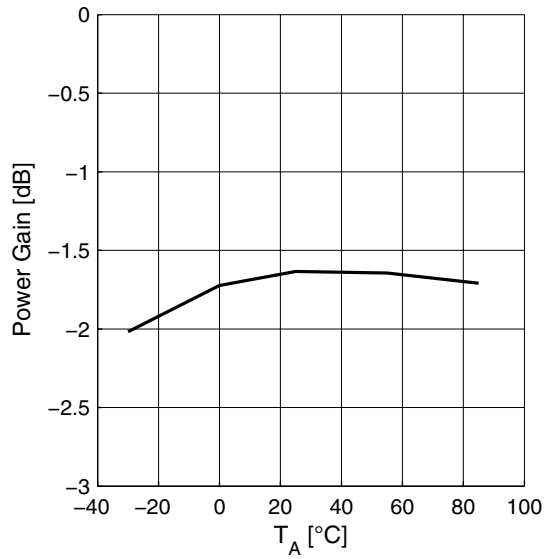

Supply Current $I_{CC} = f(T_A)$

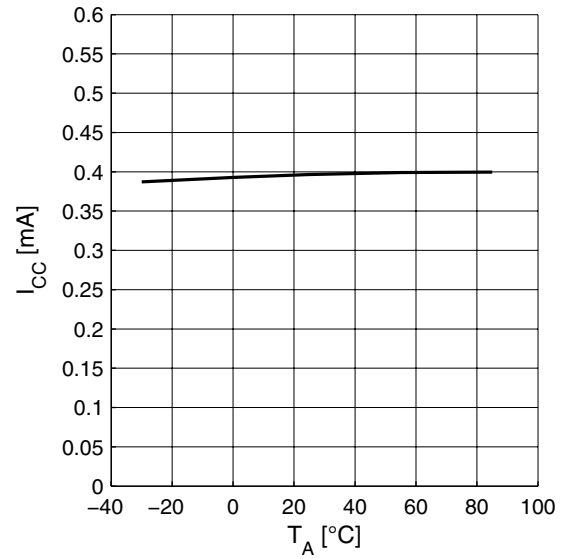

Input Compression $P1dB = f(T_A)$

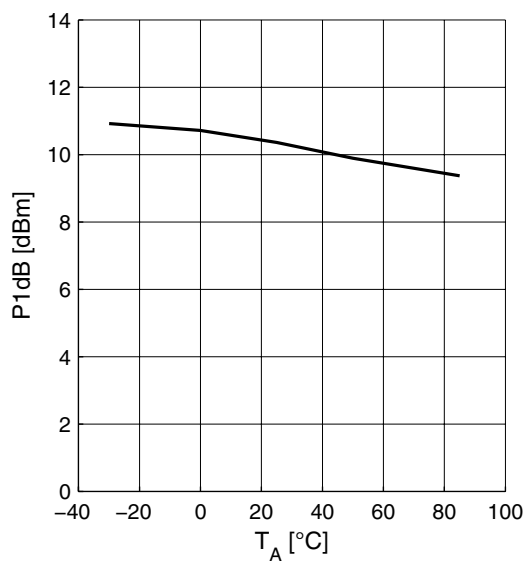

2.18 Measured Performance TX Mode in 50 Ω System vs. Voltage

$V_{CC} = 3\text{ V}$, $V_{ON} = 3\text{ V}$, $V_{MODE} = 0\text{ V}$, $f = 100\text{ MHz}$

Power Gain $|S_{21}| = f(V)$

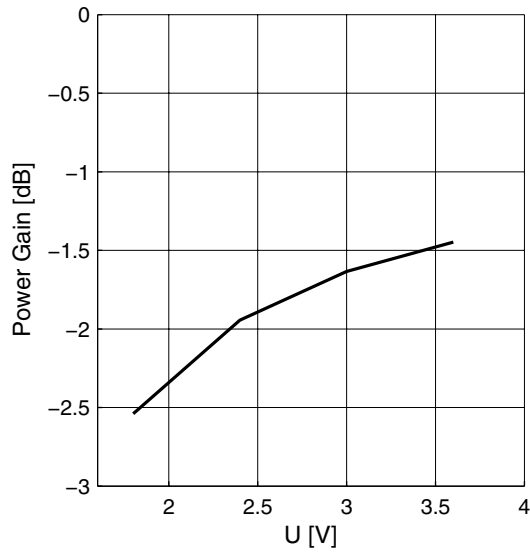

Supply Current $I_{CC} = f(V)$

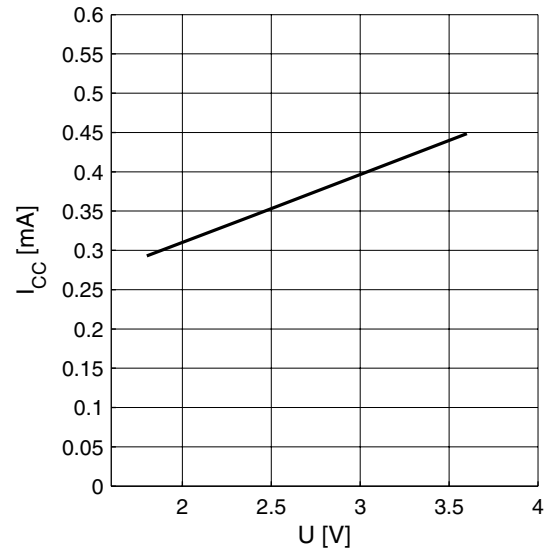

Input Compression $P1dB = f(V)$

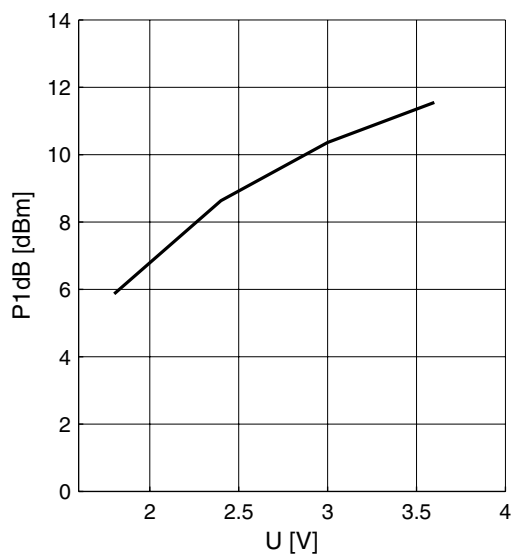

3 Application Circuit and Block Diagram

3.1 FM Radio in 50 Ω System Application Circuit Schematic

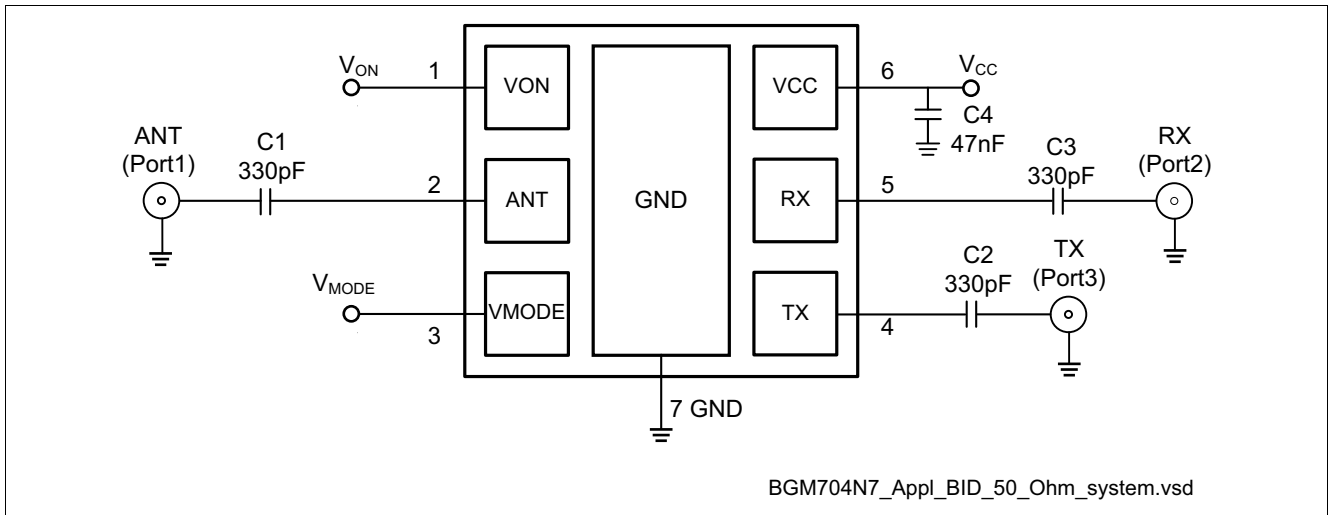

Figure 2 Application Circuit with Chip Outline (Top View)

Table 12 Bill of Materials 50 Ω Application

Part Number	Part Type	Manufacturer	Size	Comment
C1 ... C4	Chip capacitor	Various	0402	

3.2 FM Radio in High Ohmic System Application Circuit Schematic

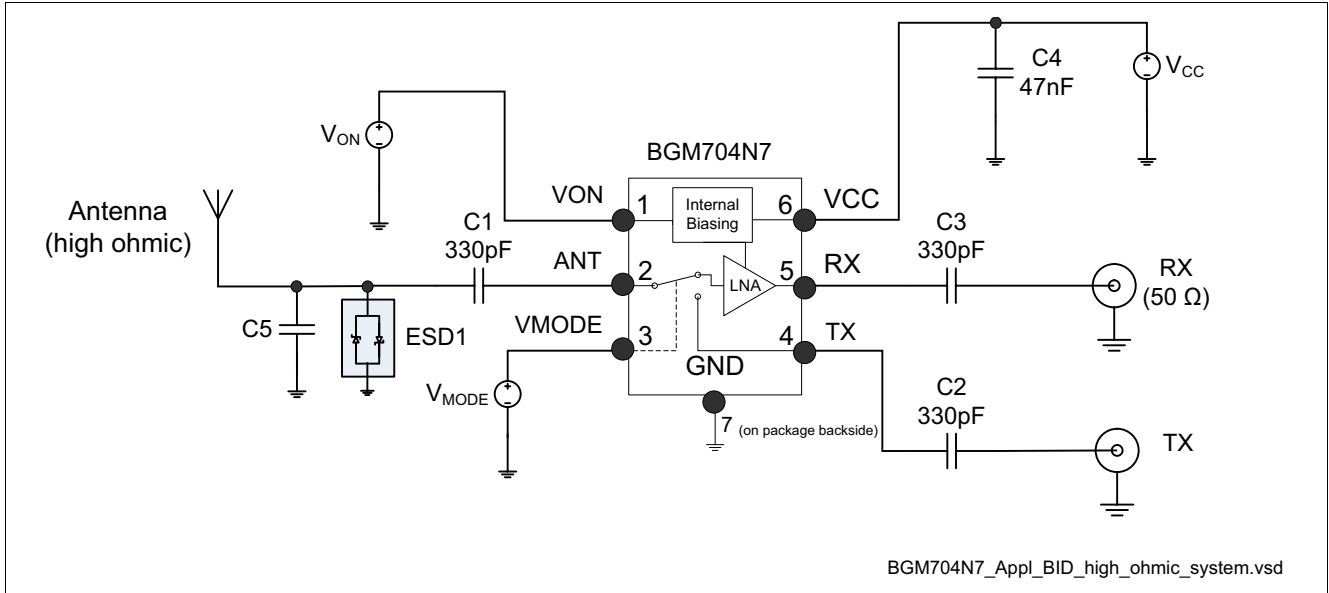

Figure 3 Application Circuit with Chip Outline High Ohmic (Top View)

Table 13 Bill of Materials High Ohmic Antenna Application

Part Number	Part Type	Manufacturer	Size	Comment
C1 ... C5	Chip capacitor	Various	0402	
ESD1	TVS diode ESD0P8RFL	Infineon	0402	Optional

3.3 Pin Description

Table 14 Pin Definition and Function

Pin No.	Name	Pin Type	Buffer Type	Function
1	VON	–	–	On / Off voltage
2	ANT	–	–	RF antenna (input / output)
3	VMODE	–	–	Control voltage
4	TX	–	–	RF input TX
5	RX	–	–	RF output RX
6	VCC	–	–	Supply voltage
7	GND	–	–	Ground connection for LNA and control circuitry (package paddle)

3.4 Application Board

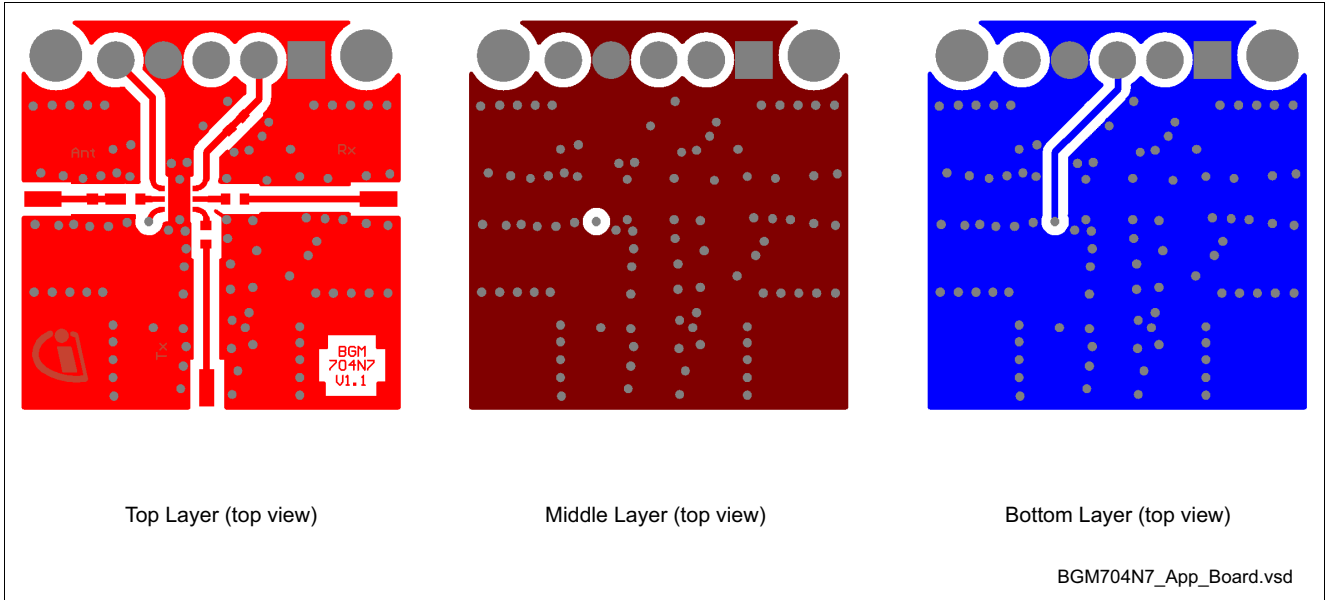

Figure 4 Application Board Layout on 3-layer FR4

Note: Top layer thickness: 0.2 mm, bottom layer thickness: 0.8 mm, 17 mm Cu metallization, gold plated. Board size: 21 x 21mm.

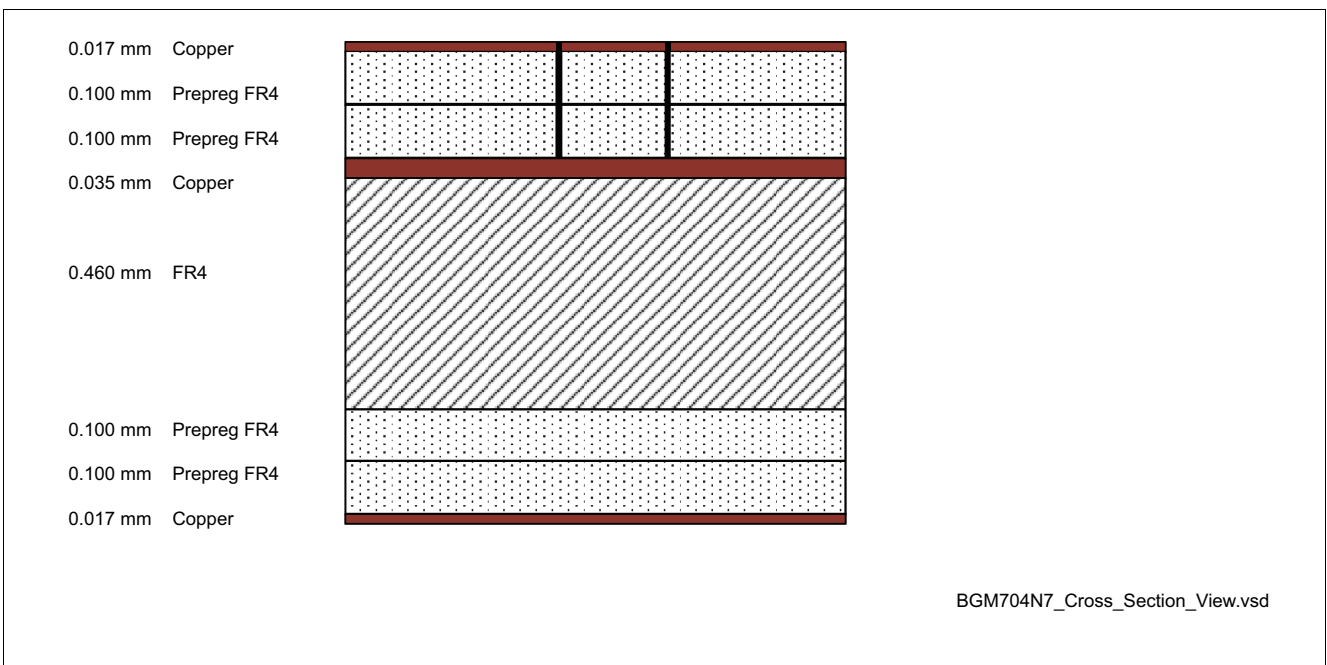

Figure 5 Cross-Section View of Application Board

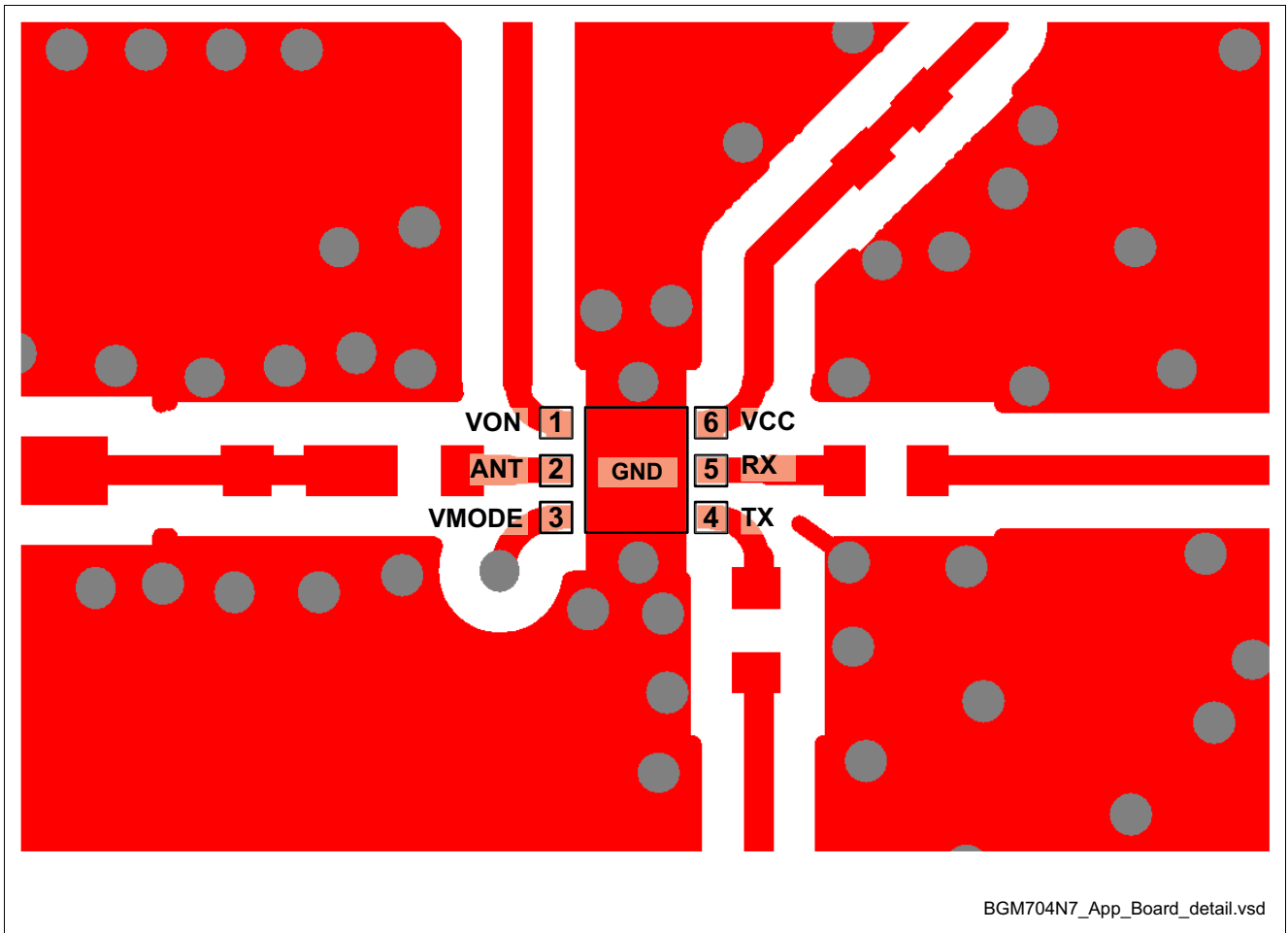

Figure 6 Detail of Application Board Layout

Note: In order to achieve the same performance as given in this datasheet please follow the suggested PCB-layout as closely as possible. The position of the GND vias is critical for RF performance.

4 Physical Characteristics

4.1 Package Footprint

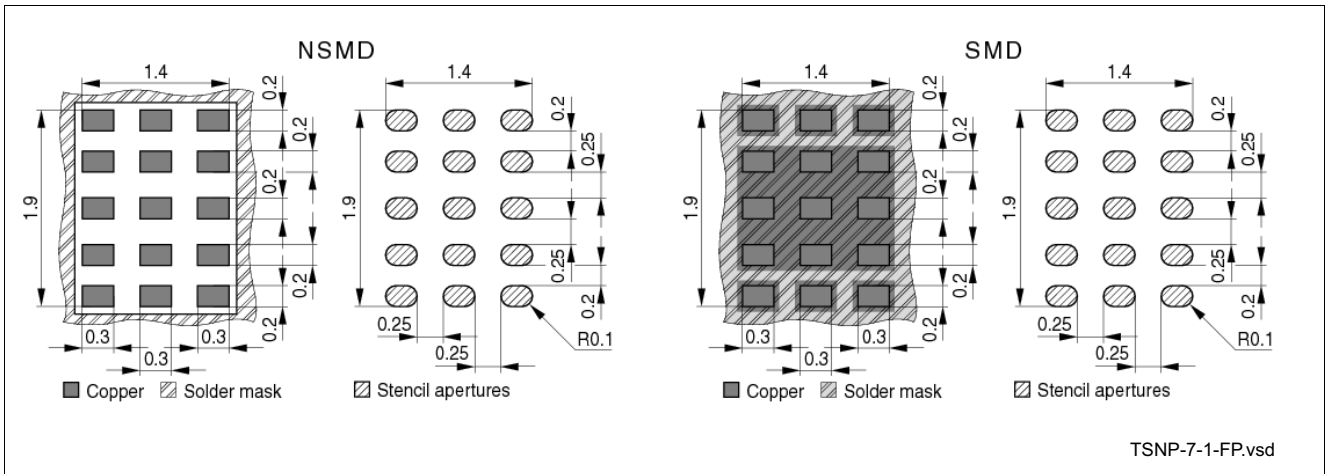

Figure 7 Recommended Footprint and Stencil Layout for the TSNP-7-1 Package

4.2 Package Dimensions

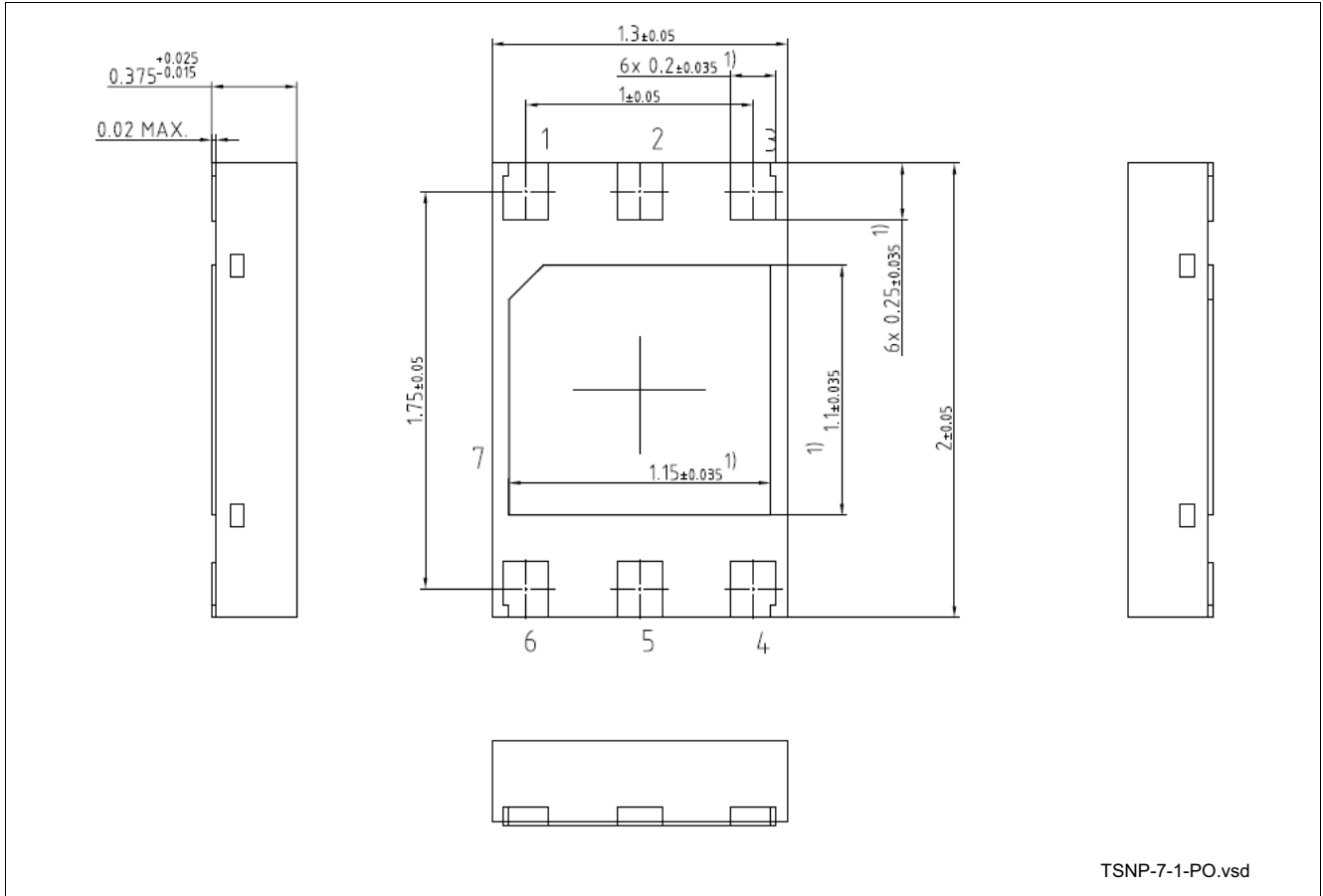

Figure 8 Package Outline (Top, Side and Bottom View)

www.infineon.com

Published by Infineon Technologies AG