

**Model 73026**  
**MMCX PLUG R/A CRIMP, RG178**

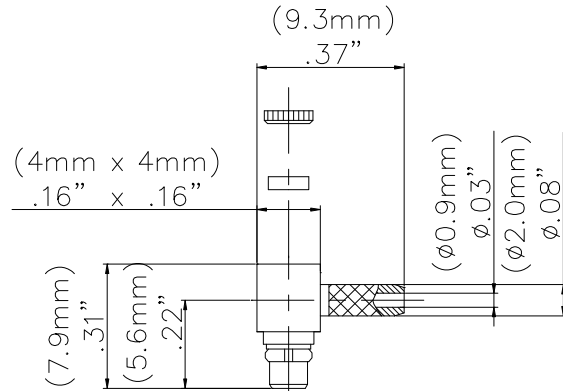

Model 73026 MMCX PLUG R/A CRIMP, RG178



Snap-on coupling and micro-miniature size for fast connect and disconnect where space is limited

**Features**

- DC - 3 GHz bandwidth.
- 50% smaller than MCX connectors.
- Connectors allow rotation of 360° for layout flexibility.
- Non-slotted contact design for low RF leakage.
- Meets CECC 22340.
- Perfect for applications where space, weight, performance and ease of assembly are required.

**Materials**

- Body is machined brass with gold plating.
- Center contacts – Plug is gold plated Phosphor bronze and Jack is gold plated beryllium copper.
- High quality PTFE insulators.
- Crimp Ferrules are gold or nickel plated copper.

**Ordering Information**

Model: 73026

Description: MMCX PLUG R/A CRIMP, RG178

USA: Sales: 800-490-2361

Technical Support: [technicalsupport@pomonatest.com](mailto:technicalsupport@pomonatest.com)

Fax: 425-446-5844

Europe: 31-(0) 40 2675 150 International: 425-446-5500

Where to Buy: [www.pomonaelectronics.com](http://www.pomonaelectronics.com)

**Specifications**

Impedance	50 Ω
Frequency Range	DC - 3 GHz
Working Voltage	170 Vrms max.
Dielectric Withstanding Voltage	500 Vrms
VSWR	1.4 max
Center / Outer contact resistance	0.01 / 0.005 Ω
Number of insertions	500 cycles minimum
Insulation resistance	> 500 MΩ
Temperature Range	-55° C to 155° C, -67° F to 311° F

All dimensions are in inches. Tolerances (except noted): .xx = ±.02" (.51 mm), .xxx = ±.005" (.127 mm). All specifications are to the latest revisions. Specifications are subject to change without notice. Registered trademarks are the property of their respective companies.  
D2003458 REV 001

**Model 73026  
MMCX PLUG R/A CRIMP, RG178**

**Cable Types and Crimp Die Information**

Connector Model #	Cable Groups	Crimp Die Cavity Size for Outer Ferrule
73026	RG178	.105 (2.67)

**Cable Assembly Instructions**

1. CUT CABLE END EVENLY AND PERPENDICULAR

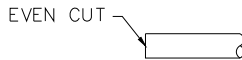

2. SLIDE OUTER FERRULE OVER CABLE END.

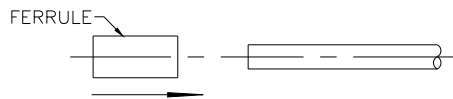

3. STRIP CABLE JACKET, BRAID, AND DIELECTRIC TO SPECIFICATION LENGTHS.

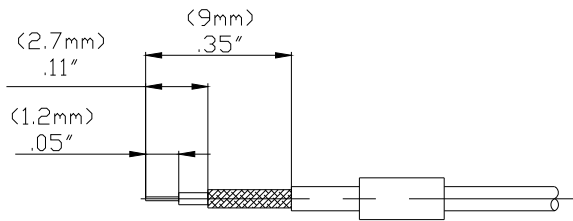

RECOMMENDED STRIP LENGTHS

4. FLARE BRAID END SLIGHTLY.

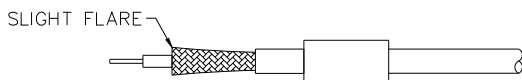

5. SLIDE CONNECTOR BODY OVER CENTER CONDUCTOR.

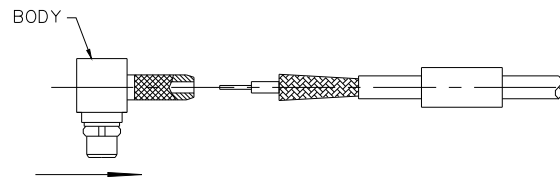

6. SLIDE OUTER FERRULE OVER BRAID AND UP AGAINST BODY ASSEMBLY.

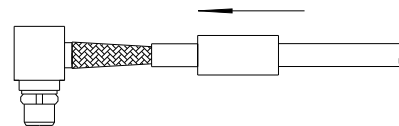

7. CRIMP OUTER FERRULE WITH APPROPRIATE CRIMP TOOL.

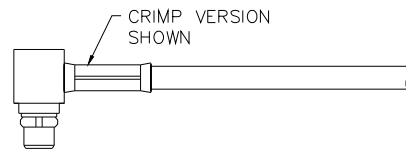

8. PRESS INSULATOR AND CAP INTO CONNECTOR BODY AS SHOWN.

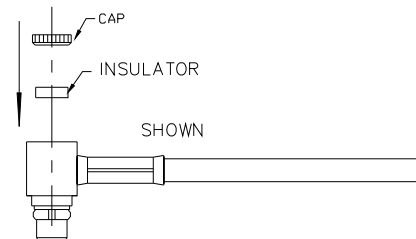

**USA:** Sales: 800-490-2361  
 Technical Support: [technicalsupport@pomonaest.com](mailto:technicalsupport@pomonaest.com)  
 Fax: 425-446-5844  
**Europe:** 31-(0) 40 2675 150 **International:** 425-446-5500  
**Where to Buy:** [www.pomonaelectronics.com](http://www.pomonaelectronics.com)

All dimensions are in inches. Tolerances (except noted): .xx = ±.02" (.51 mm), .xxx = ±.005" (.127 mm). All specifications are to the latest revisions. Specifications are subject to change without notice. Registered trademarks are the property of their respective companies.  
 D2003458 REV 001