

Ku Band, 2 Watt Power Amplifier

TGA2510-TS

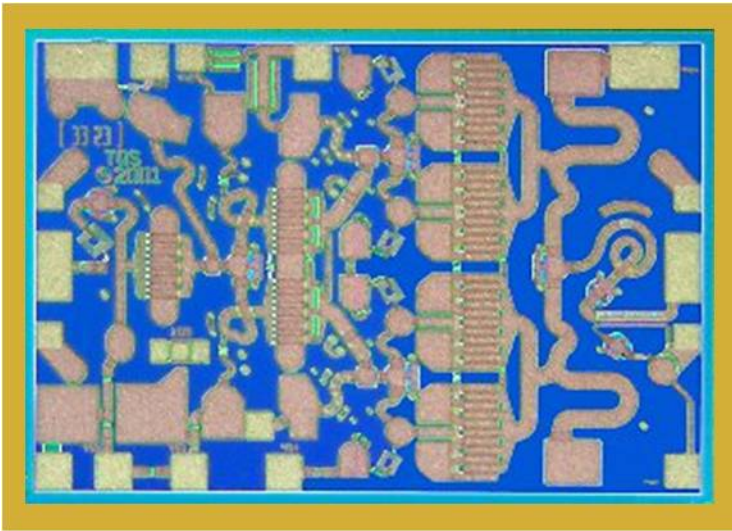

Key Features and Performance

- 34 dBm Midband Psat
- 26 dB Nominal Gain
- 7 dB Typical Input Return Loss
- 12 dB Typical Output Return Loss
- 12.5 - 17 GHz Frequency Range
- Directional Power Detector with Reference
- 0.25µm pHEMT 3MI Technology
- Bias Conditions: 7.5V, 650mA
- Thermal Spreader Dimensions: 2.159 x 1.499 mm

Preliminary Measured Performance

Bias Conditions: $V_d=7.5V$ $I_d=650mA$

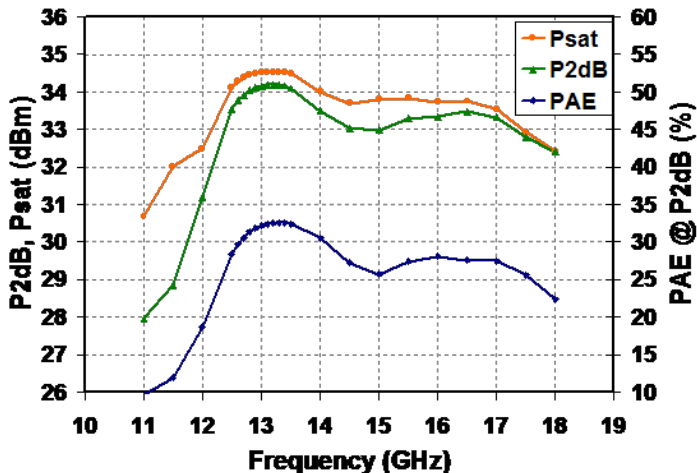
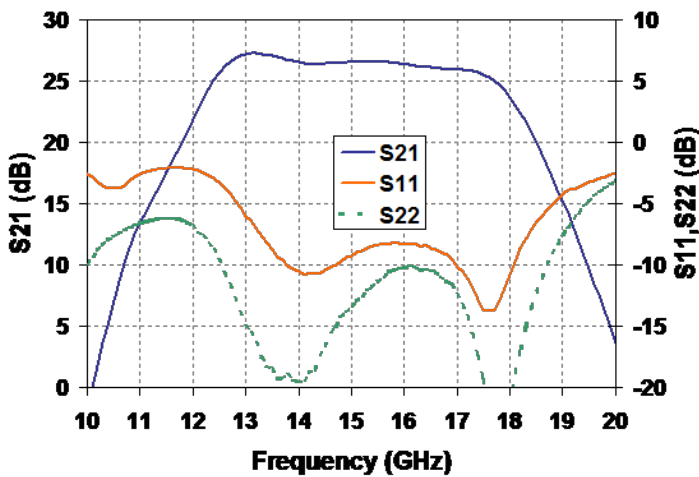

Primary Applications

- VSAT
- Point to Point

Note: Datasheet is subject to change without notice.

**TABLE I
ABSOLUTE MAXIMUM RATINGS**

Symbol	Parameter	Value	Notes
V_D	Drain Voltage	8 V	<u>1/</u> <u>2/</u>
V_G	Gate Voltage Range	-5V to 0V	<u>1/</u>
I_D	Drain Supply Current	1300 mA	<u>1/</u> <u>2/</u>
$ I_G $	Gate Supply Current	18 mA	<u>1/</u>
P_{IN}	Input Continuous Wave Power	24 dBm	<u>1/</u> <u>2/</u>
P_D	Power Dissipation	10.4 W	<u>1/</u> <u>2/</u>
T_{CH}	Operating Channel Temperature	200 °C	<u>3/</u>
T_M	Mounting Temperature (30 Seconds)	320 °C	
T_{STG}	Storage Temperature	-65 to 150 °C	

- 1/ These ratings represent the maximum operable values for this device
- 2/ Combinations of supply voltage, supply current, input power, and output power shall not exceed P_D at a package base temperature of 70°C
- 3/ Junction operating temperature will directly affect the device median lifetime. For maximum life, it is recommended that channel temperatures be maintained at the lowest possible levels.

**TABLE II
RECOMMENDED OPERATING CONDITIONS**

Symbol	Parameter	Value
Vd	Drain Voltage	7.5 V
Id	Drain Current	650 mA
Id_Drive	Drain Current under RF Drive	1200 mA
Vg3, Vg4	Gate Voltage	-0.65 V typical

TABLE III
RF CHARACTERIZATION TABLE
 (T_A = 25°C, Nominal)
 (V_d = 7.5V, I_{dq} = 650mA ±5%)

Symbol	Parameter	Test Conditions	Typ	Units	Notes
Gain	Small Signal Gain	F = 12.5 – 17 GHz	26	dB	
IRL	Input Return Loss	F = 12.5 – 17 GHz	7	dB	
ORL	Output Return Loss	F = 12.5 – 17 GHz	12	dB	
PWR	Output Power @ Pin = +15dBm	F = 12.5 – 17 GHz	34.0	dBm	
PAE	Power Added Efficiency @ Pin=+15dBm	F = 12.5 – 17 GHz	31	%	

TABLE IV
THERMAL INFORMATION

Parameter	Test Conditions	T _{CH} (°C)	Θ _{jc} (°C/W)	T _m (hrs)
Θ _{jc} Thermal Resistance (Channel to Backside of Carrier)	V _D = 7.5V I _D = 650mA P _{DISS} = 4.88W T _{BASE} = 70°C	130.7	12.44	5.5E+6

Note: Assumes eutectic attach using 1.5mil 80/20 AuSn mounted to a 20mil CuMo carrier at 70°C baseplate temperature. Worst case conditions with no RF applied, 100% of DC power is dissipated.

Typical Fixtured Performance
Idq=650mA

TGA2510-TS

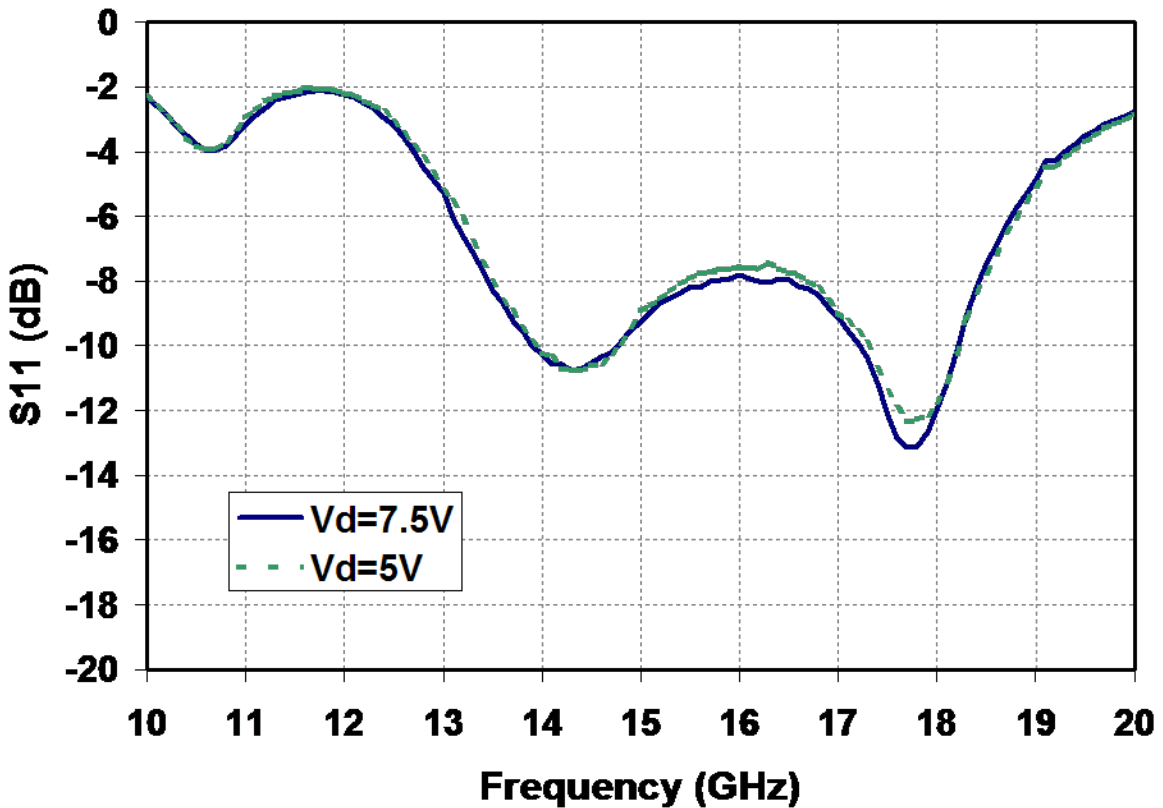
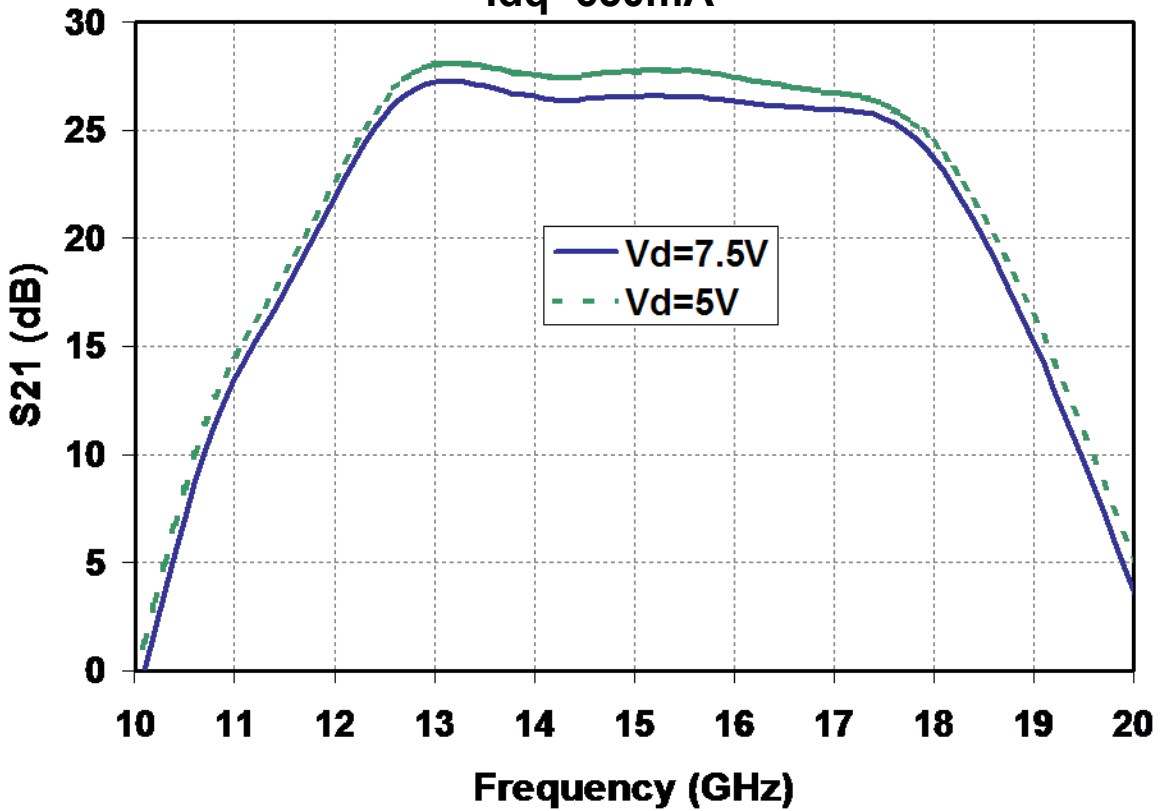

Typical Fixtured Performance
Idq=650mA

TGA2510-TS

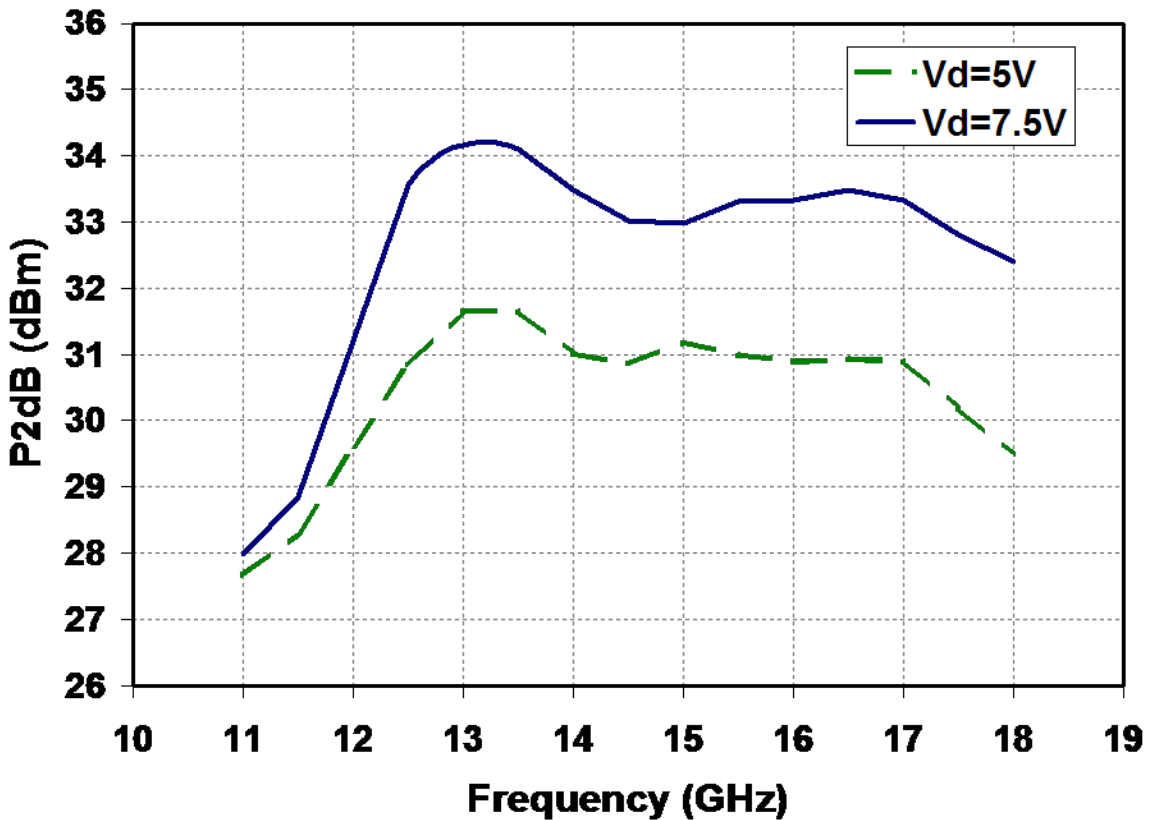
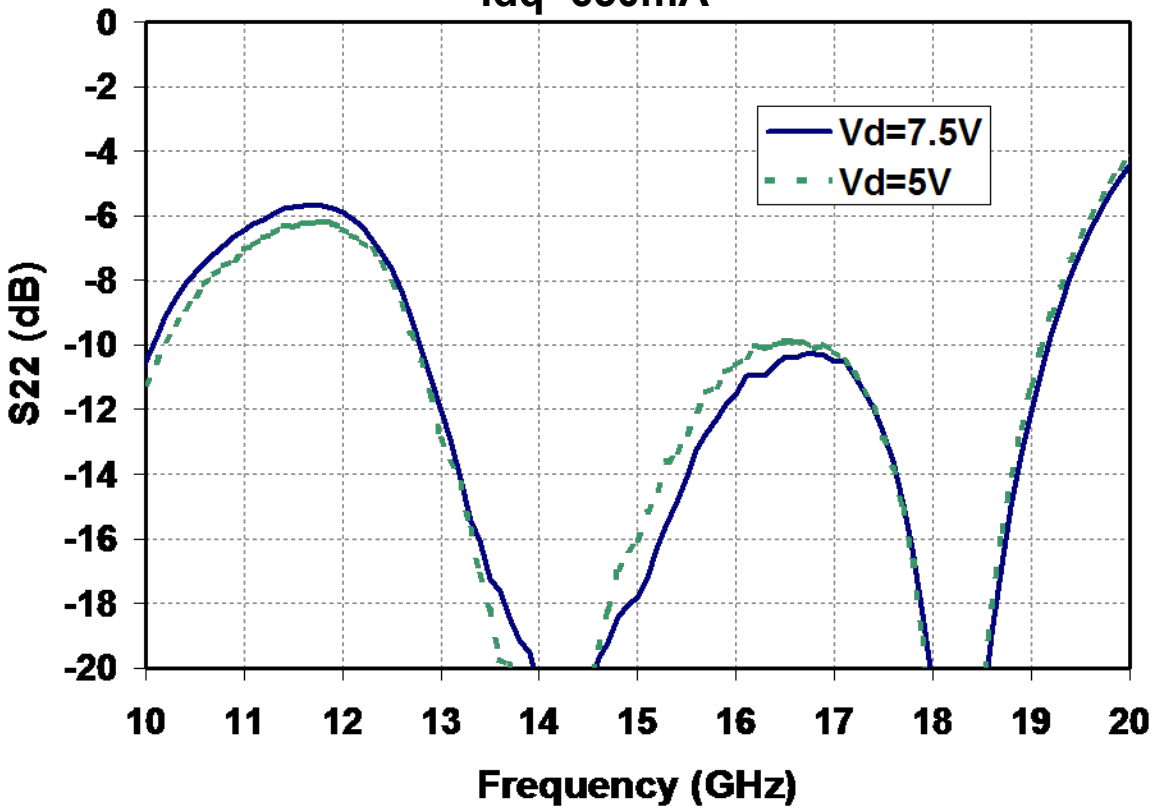

Typical Fixtured Performance
Idq=650mA

TGA2510-TS

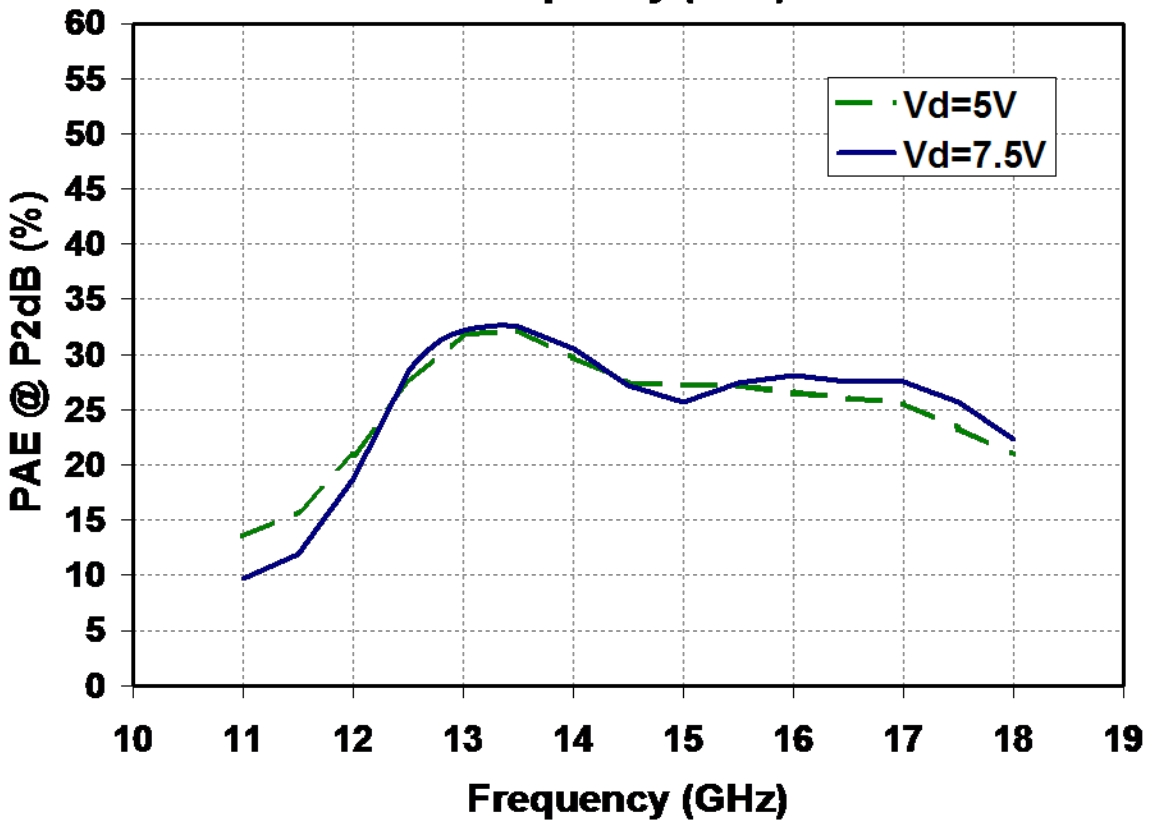
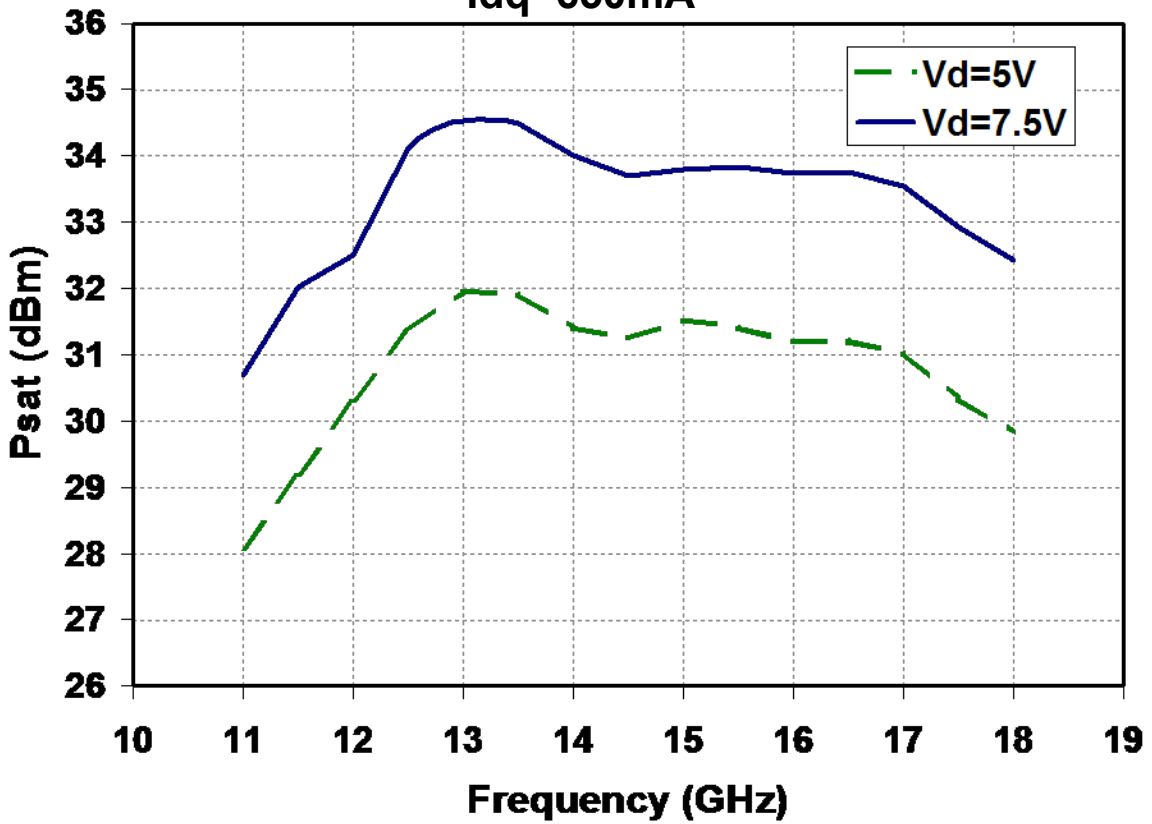

Typical Fixtured Performance
Idq=650mA

TGA2510-TS

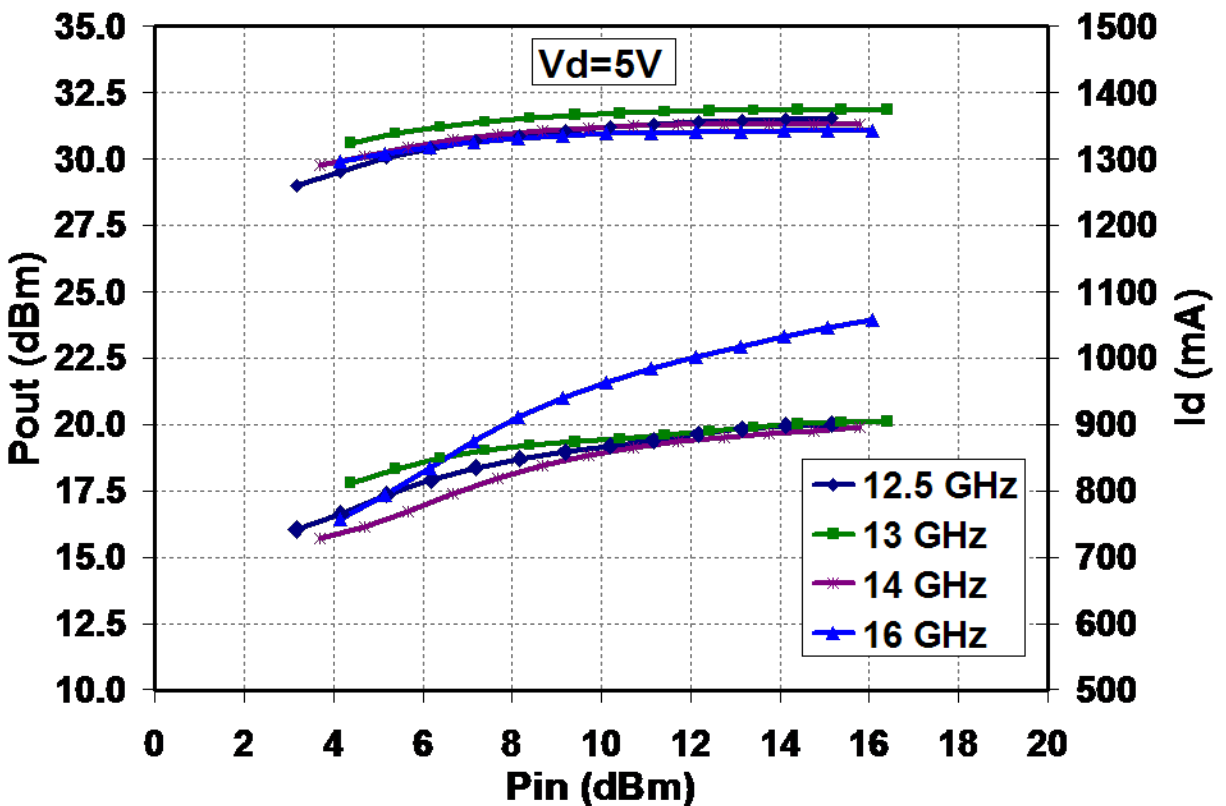
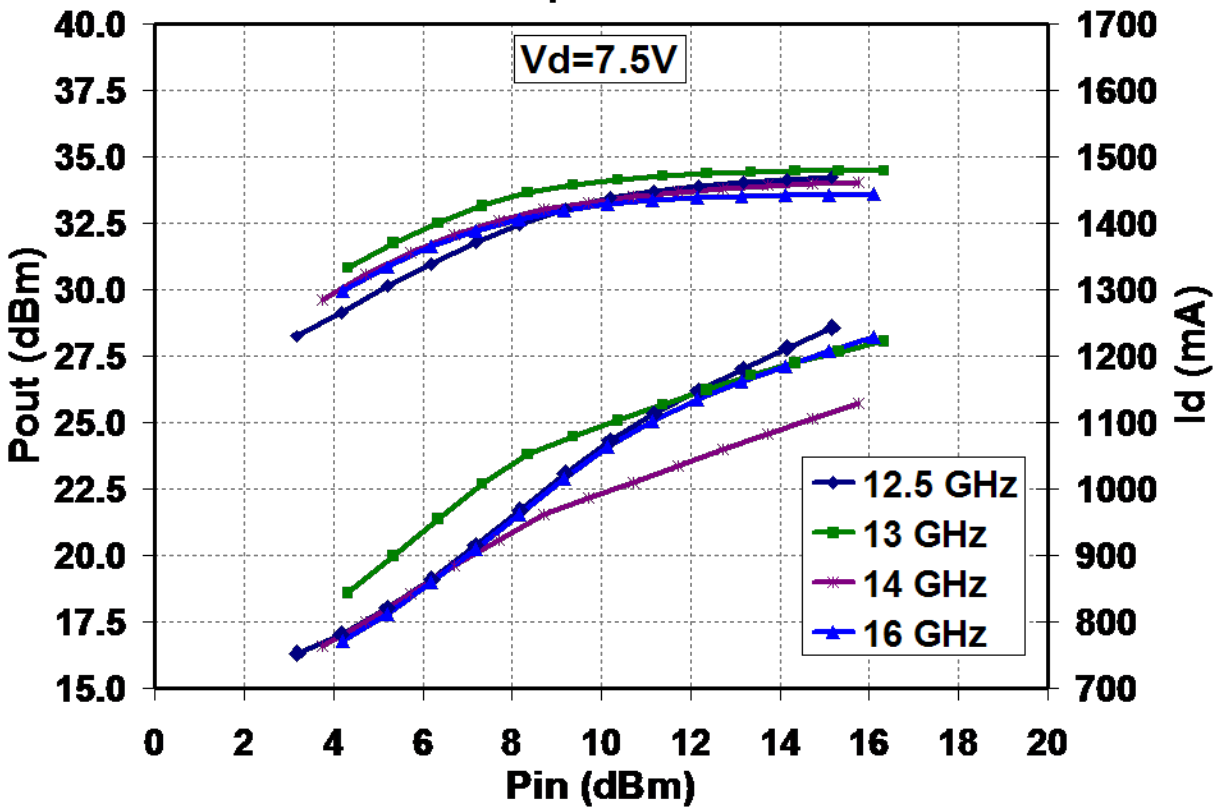

Mechanical Drawing

TGA2510-TS

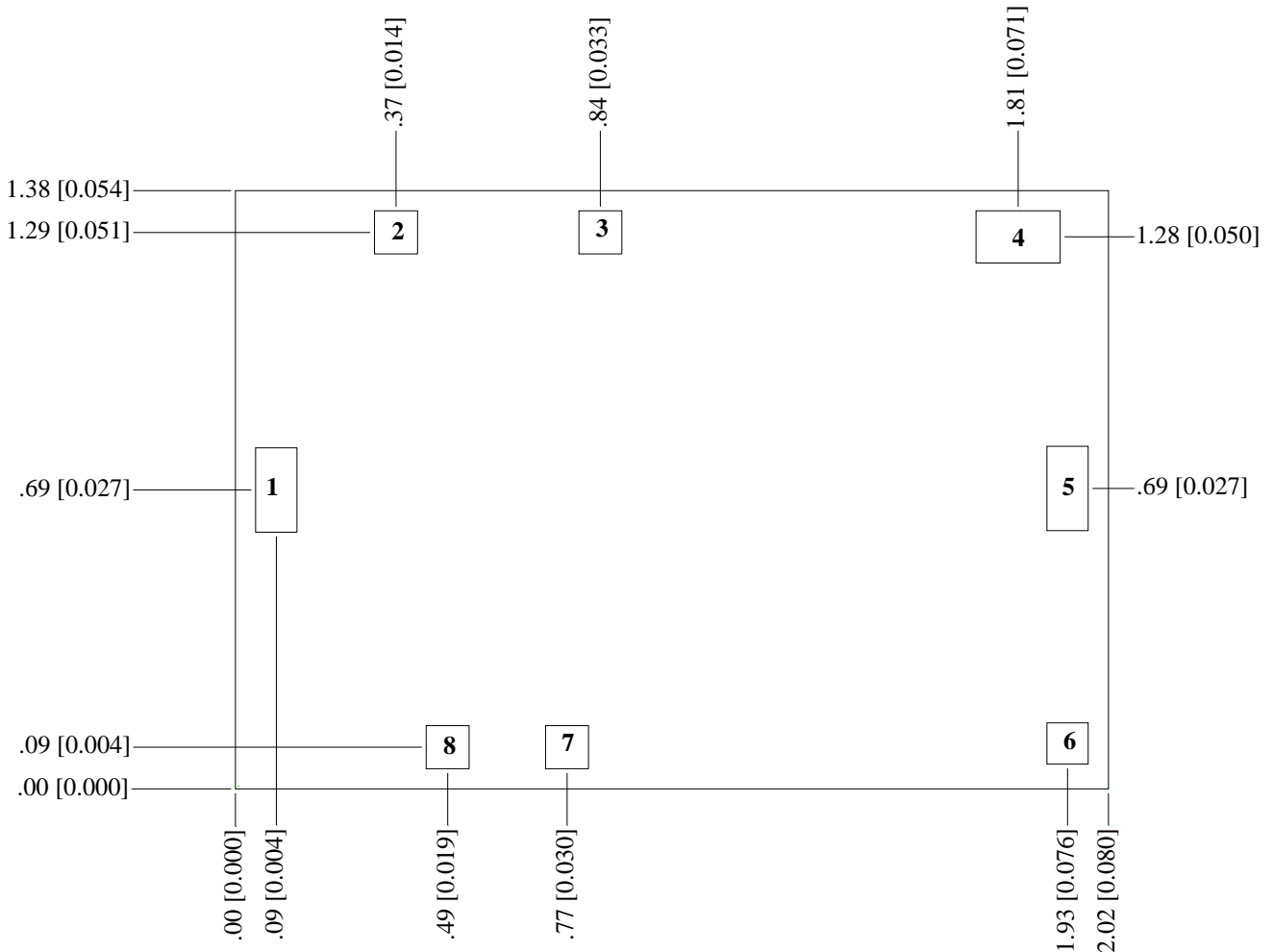

Units: millimeters [inches]

Thickness: 0.10 [0.004] (reference only)

Chip edge to bond pad dimensions are shown to center of bond pads.

Chip size tolerance: ± 0.05 [0.002]

RF ground through backside

Bond Pad #1	RF Input	0.10 x 0.20	[0.004 x 0.008]
Bond Pad #2	Vref	0.10 x 0.10	[0.004 x 0.004]
Bond Pad #3	Vd3	0.10 x 0.20	[0.004 x 0.008]
Bond Pad #4	Vd4	0.20 x 0.13	[0.008 x 0.005]
Bond Pad #5	RF Output	0.10 x 0.20	[0.004 x 0.008]
Bond Pad #6	Vdet	0.10 x 0.10	[0.004 x 0.004]
Bond Pad #7	Vg4	0.10 x 0.10	[0.004 x 0.004]
Bond Pad #8	Vg3	0.10 x 0.10	[0.004 x 0.004]

TGA2510 on Thermal Spreader

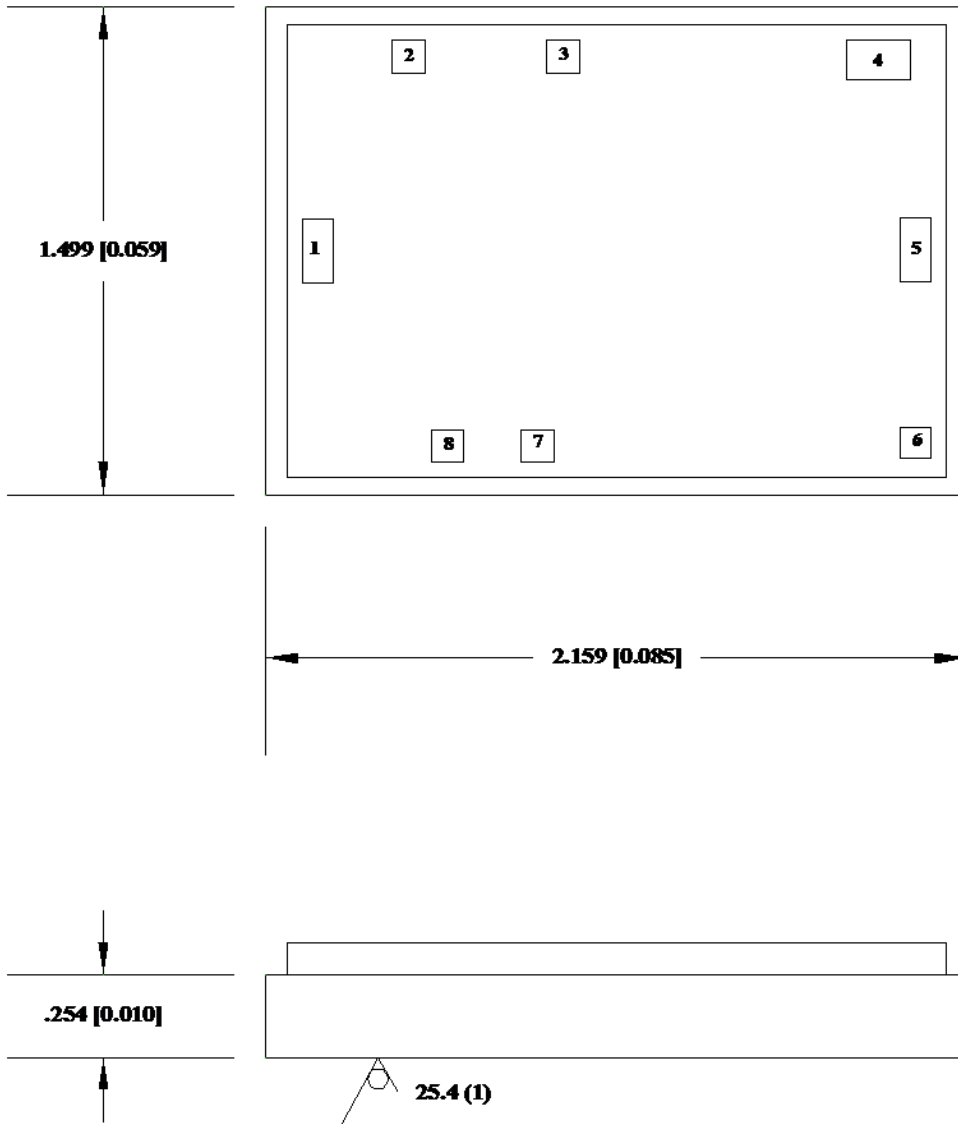

Notes:

1. Dimensions are in mm[inches].
2. Dimension limits apply after plating.
3. Dimension of surface roughness is in micrometer(microinch).
4. Tolerances unless otherwise stated +0.075, - 0.025 [+0.003, -0.001]
5. Thermal Spreader Material:
Copper and Molybdenum metal matrix material (AMC8515) with a CTE of 7.0 ppm/C.
6. Plating:
Gold (Au) 1.27-2.54 um per ASTM B 488, Type 1, Code A.
over
Nickel (Ni) 2.5-7.5 um per QQ-N-290, Class 1.
7. MMIC is attached to thermal spreader using AuSn solder.

Power Detector

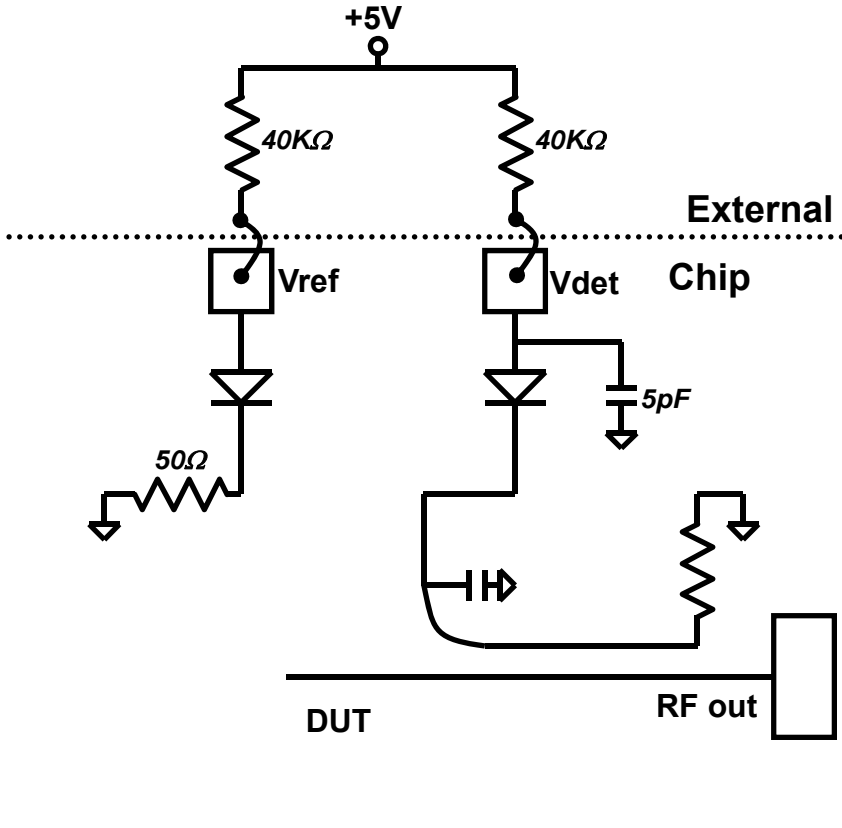

TGA2510 Power Detector @ 14GHz

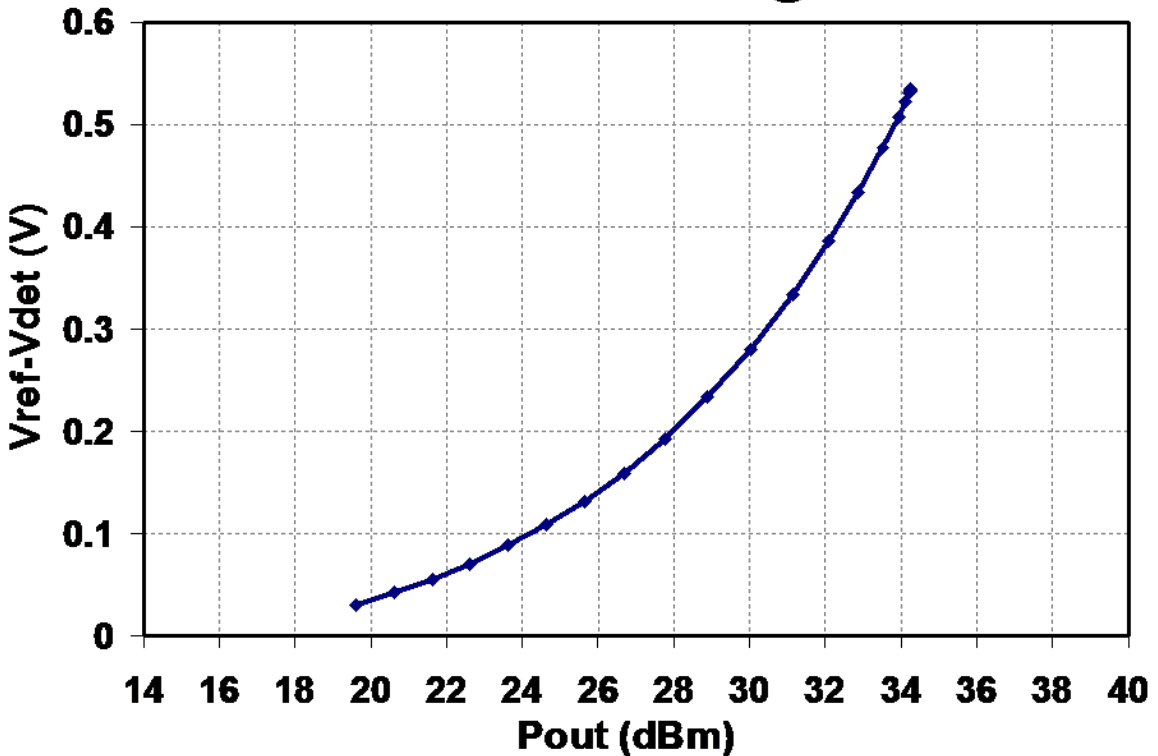

Chip Assembly & Bonding Diagram

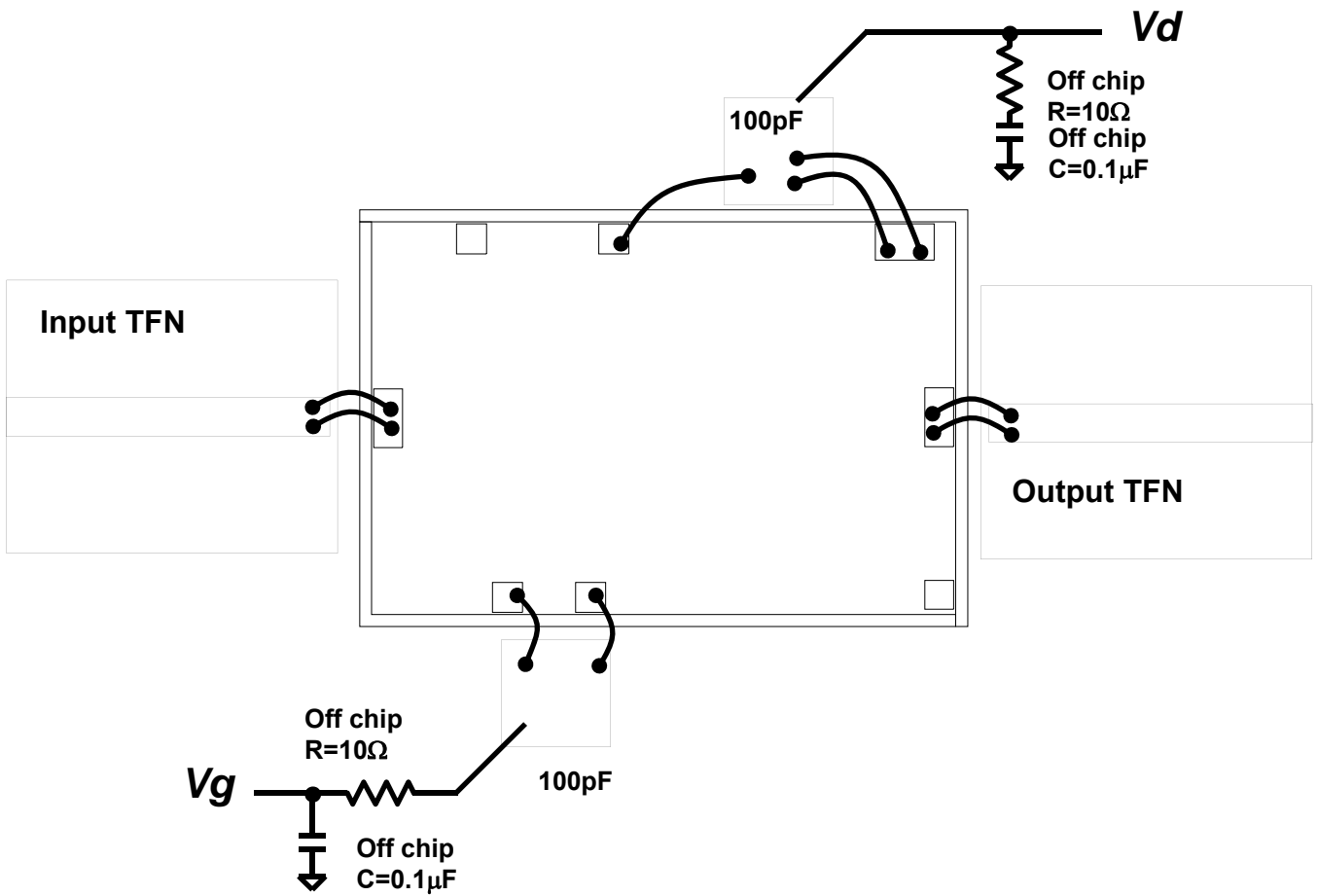

GaAs MMIC devices are susceptible to damage from Electrostatic Discharge. Proper precautions should be observed during handling, assembly and test.

Assembly Process Notes

Component storage placement and adhesive attachment assembly notes:

- Vacuum pencils and/or vacuum collets are the preferred method of pick up.
- Air bridges must be avoided during placement.
- The force impact is critical during auto placement.
- Attachment of the thermal spreader should use an epoxy with high thermal conductivity.
- Curing should be done in a convection oven.
- Microwave or radiant curing should not be used because of differential heating.

Interconnect process assembly notes:

- Thermosonic ball bonding is the preferred interconnect technique.
- Force, time, and ultrasonics are critical parameters.
- Aluminum wire should not be used.
- Devices with small pad sizes should be bonded with 0.0007-inch wire.
- Maximum stage temperature is 200 °C.

Ordering Information

Part	Package Style
TGA2510-TS	GaAs MMIC Die on Thermal Spreader

GaAs MMIC devices are susceptible to damage from Electrostatic Discharge. Proper precautions should be observed during handling, assembly and test.