

Features

- 168 Pin Unbuffered 16,777,216 x 64 bit Organization SDRAM DIMM
- Utilizes High Performance 128 Mbit, 8M x 16 SDRAM in TSOPII-54 Packages
- Fully PC Board Layout Compatible to INTEL'S Rev 1.0 Module Specification
- Single +3.3V (± 0.3V) Power Supply
- Programmable CAS Latency, Burst Length, and Wrap Sequence (Sequential & Interleave)
- Auto Refresh (CBR) and Self Refresh
- All Inputs, Outputs are LVTTTL Compatible
- 4096 Refresh Cycles every 64 ms
- Serial Present Detect (SPD)
- SDRAM Performance

Description

The V436516R04V(L) memory module is organized 16,777,216 x 64 bits in a 168 pin dual in line memory module (DIMM). The 16M x 64 memory module uses 8 Mosel-Vitellic 8M x 16 SDRAM. The x64 modules are ideal for use in high performance computer systems where increased memory density and fast access times are required.

Part Number	Speed Grade	Configuration
V436516R04VXTG-75L	-75, CL=3 (133 MHz)	16M x 64
V436516R04VXTG-75PCL	-75PC, CL=2,3 (133 MHz)	16M x 64
V436516R04VXTG-10PCL	-10PC, CL=2,3 (100 MHz)	16M x 64

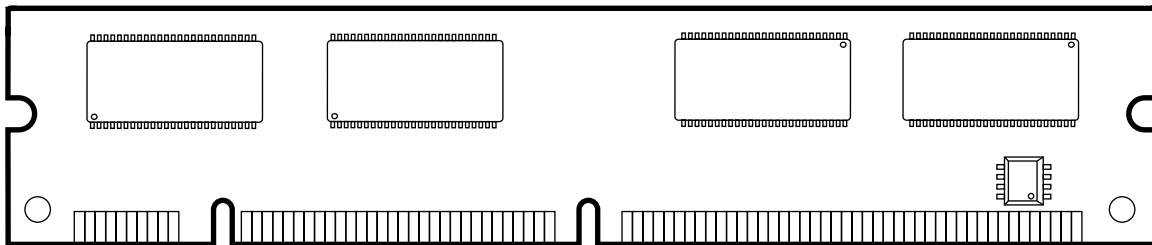

Pin Configurations (Front Side/Back Side)

Pin	Front	Pin	Front	Pin	Front	Pin	Back	Pin	Back	Pin	Back
1	VSS	29	DQM1	57	I/O19	85	VSS	113	DQM5	141	I/O51
2	I/O1	30	$\overline{CS0}$	58	I/O20	86	I/O33	114	$\overline{CS1}$	142	I/O52
3	I/O2	31	DU	59	VCC	87	I/O34	115	RAS	143	VCC
4	I/O3	32	VSS	60	I/O21	88	I/O35	116	VSS	144	I/O53
5	I/O4	33	A0	61	NC	89	I/O36	117	A1	145	NC
6	VCC	34	A2	62	DU	90	VCC	118	A3	146	DU
7	I/O5	35	A4	63	CKE1	91	I/O37	119	A5	147	NC
8	I/O6	36	A6	64	VSS	92	I/O38	120	A7	148	VSS
9	I/O7	37	A8	65	I/O22	93	I/O39	121	A9	149	I/O54
10	I/O8	38	A10(AP)	66	I/O23	94	I/O40	122	BA0	150	I/O55
11	I/O9	39	BA1	67	I/O24	95	I/O41	123	A11	151	I/O56
12	VSS	40	VCC	68	VSS	96	VSS	124	VCC	152	VSS
13	I/O10	41	VCC	69	I/O25	97	I/O42	125	CLK1	153	I/O57
14	I/O11	42	CLK0	70	I/O26	98	I/O43	126	NC	154	I/O58
15	I/O12	43	VSS	71	I/O27	99	I/O44	127	VSS	155	I/O59
16	I/O13	44	DU	72	I/O28	100	I/O45	128	CKE0	156	I/O60
17	I/O14	45	$\overline{CS2}$	73	VCC	101	I/O46	129	$\overline{CS3}$	157	VCC
18	VCC	46	DQM2	74	I/O29	102	VCC	130	DQM6	158	I/O61
19	I/O15	47	DQM3	75	I/O30	103	I/O47	131	DQM7	159	I/O62
20	I/O16	48	DU	76	I/O31	104	I/O48	132	DU	160	I/O63
21	CBO*	49	VCC	77	I/O32	105	CB4*	133	VCC	161	I/O64
22	CB1*	50	NC	78	VSS	106	CB5*	134	NC	162	VSS
23	VSS	51	NC	79	CLK2	107	VSS	135	NC	163	CLK3
24	NC	52	CB2*	80	NC	108	NC	136	CB6*	164	NC
25	NC	53	CB3*	81	WP	109	NC	137	CB7*	165	SA0
26	VCC	54	VSS	82	SDA	110	VCC	138	VSS	166	SA1
27	\overline{WE}	55	I/O17	83	SCL	111	CAS	139	I/O49	167	SA2
28	DQM0	56	I/O18	84	VCC	112	DQM4	140	I/O50	168	VCC

Notes:

* These pins are not used in this module.

Pin Names

A0–A11	Address Inputs
I/O1–I/O64	Data Inputs/Outputs
\overline{RAS}	Row Address Strobe
\overline{CAS}	Column Address Strobe
\overline{WE}	Read/Write Input
BA0, BA1	Bank Selects
$\overline{CKE0}$, $\overline{CKE1}$	Clock Enable
$\overline{CS0}$ – $\overline{CS3}$	Chip Select
CLK0–CLK3	Clock Input
DQM0–DQM7	Data Mask
VCC	Power (+3.3 Volts)
VSS	Ground
SCL	Clock for Presence Detect

SDA	Serial Data OUT for Presence Detect
SA0–A2	Serial Data IN for Presence Detect
CB0–CB7	Check Bits (x72 Organization)
NC	No Connection
DU	Don't Use

Part Number Information

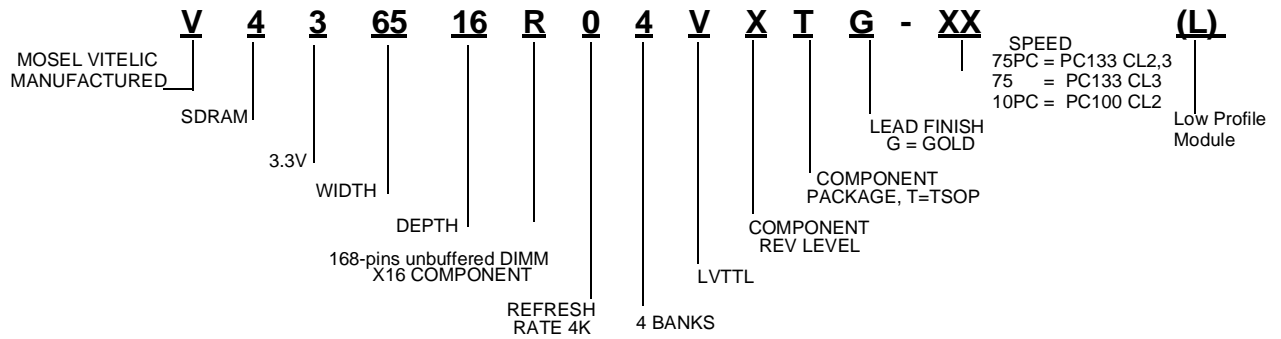

Block Diagram

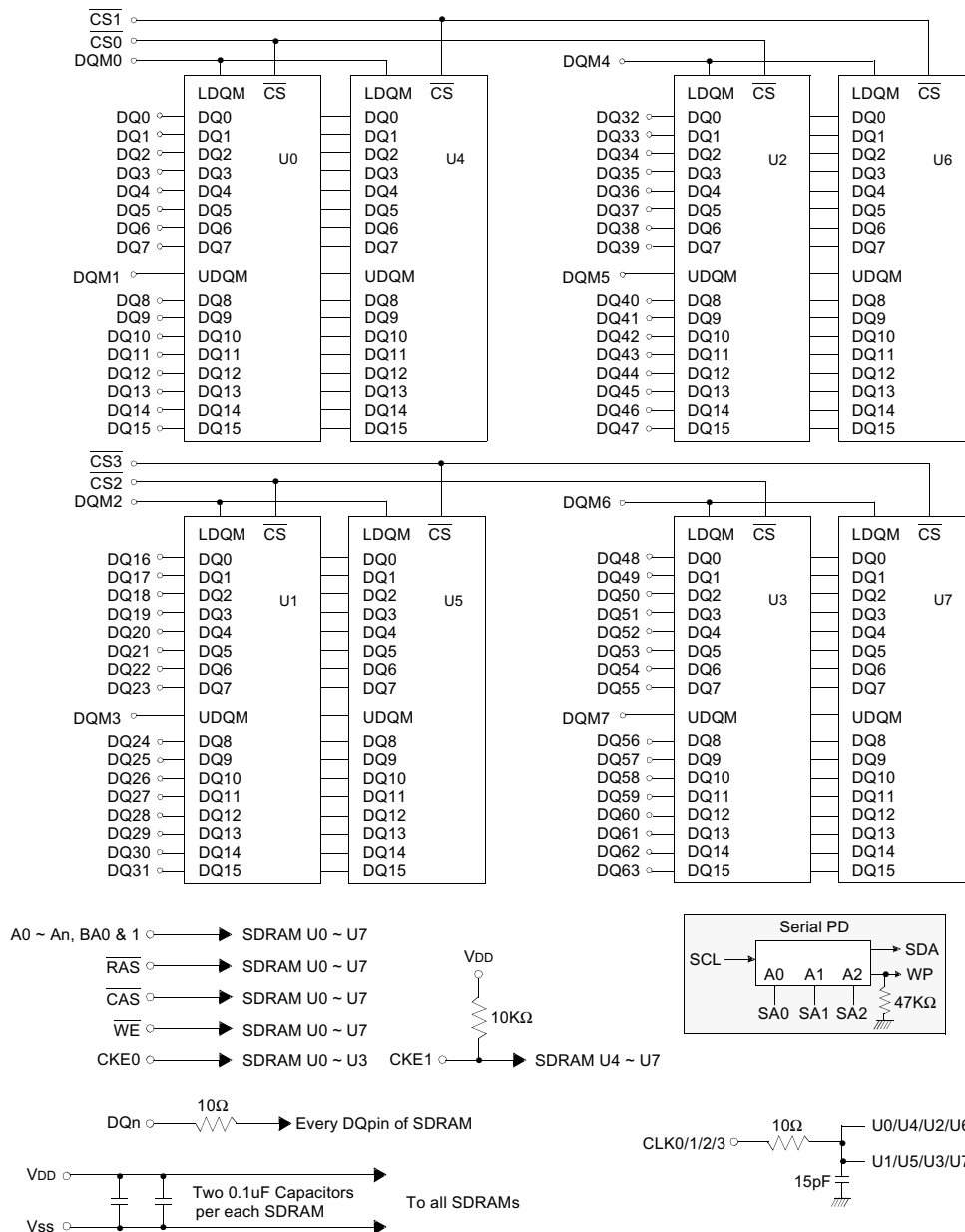

Serial Presence Detect Information

A serial presence detect storage device - E²PROM - is assembled onto the module. Information about the module configuration, speed, etc. is

written into the E²PROM device during module production using a serial presence detect protocol (I²C synchronous 2-wire bus)

SPD Table

Byte Number	Function Described	SPD Entry Value	Hex Value		
			-75PC	-75	-10PC
0	Number of SPD bytes	128	80	80	80
1	Total bytes in Serial PD	256	08	08	08
2	Memory Type	SDRAM	04	04	04
3	Number of Row Addresses (without BS bits)	12	0C	0C	0C
4	Number of Column Addresses (for x16 SDRAM)	9	09	09	09
5	Number of DIMM Banks	2	02	02	02
6	Module Data Width	64	40	40	40
7	Module Data Width (continued)	0	00	00	00
8	Module Interface Levels	LVTTTL	01	01	01
9	SDRAM Cycle Time at CL=3	7.5 ns/10.0 ns	75	75	A0
10	SDRAM Access Time from Clock at CL=3	5.4 ns/6.0 ns	54	54	60
11	Dimm Config (Error Det/Corr.)	none	00	00	00
12	Refresh Rate/Type	Self-Refresh, 15.6μs	80	80	80
13	SDRAM width, Primary	x16	10	10	10
14	Error Checking SDRAM Data Width	n/a / x8	00	00	00
15	Minimum Clock Delay from Back to Back Random Column Address	t _{ccd} = 1 CLK	01	01	01
16	Burst Length Supported	1, 2, 4, 8	0F	0F	0F
17	Number of SDRAM Banks	4	04	04	04
18	Supported $\overline{\text{CAS}}$ Latencies	CL = 3, 2	06	06	06
19	$\overline{\text{CS}}$ Latencies	$\overline{\text{CS}}$ Latency = 0	01	01	01
20	$\overline{\text{WE}}$ Latencies	WL = 0	01	01	01
21	SDRAM DIMM Module Attributes	Non Buffered/Non Reg.	00	00	00
22	SDRAM Device Attributes: General	V _{cc} tol ± 10%	0E	0E	0E
23	Minimum Clock Cycle Time at $\overline{\text{CAS}}$ Latency = 2	7.5 ns/10.0 ns	75	A0	A0
24	Maximum Data Access Time from Clock for CL = 2	5.4 ns/6.0 ns	54	60	60
25	Minimum Clock Cycle Time at CL = 1	Not Supported	00	00	00
26	Maximum Data Access Time from Clock at CL = 1	Not Supported	00	00	00
27	Minimum Row Precharge Time	15 ns/20 ns	0F	14	14

SPD (Continued) Table

Byte Number	Function Described	SPD Entry Value	Hex Value		
			-75PC	-75	-10PC
28	Minimum Row Active to Row Active Delay t_{RRD}	14 ns/15 ns/16 ns	0E	0F	10
29	Minimum RAS to CAS Delay t_{RCD}	15 ns/20 ns	0F	14	14
30	Minimum RAS Pulse Width t_{RAS}	42 ns/45 ns	2A	2D	2D
31	Module Bank Density (Per Bank)	64 MByte	10	10	10
32	SDRAM Input Setup Time	1.5 ns/2.0 ns	15	15	20
33	SDRAM Input Hold Time	0.8 ns/1.0 ns	08	08	10
34	SDRAM Data Input Setup Time	1.5 ns/2.0 ns	15	15	20
35	SDRAM Data Input Hold Time	0.8 ns/1.0 ns	08	08	10
62-61	Superset Information (May be used in Future)		00	00	00
62	SPD Revision	Revision 2/1.2	02	02	12
63	Checksum for Bytes 0 - 62		D2	17	85
64	Manufacturer's JEDEC ID Code	Mosel Vitelic	40	40	40
65-71	Manufacturer's JEDEC ID Code (cont.)		00	00	00
72	Manufacturing Location				
73-90	Module Part Number (ASCII)	V436516R04V(L)			
91-92	PCB Identification Code				
93	Assembly Manufacturing Date (Year)				
94	Assembly Manufacturing Date (Week)				
95-98	Assembly Serial Number				
99-125	Reserved		00	00	00
126	Intel Specification for Frequency		64	64	64
127	Supported frequency				
128+	Unused Storage Location		00	00	00

DC Characteristics

$T_A = 0^\circ\text{C}$ to 70°C ; $V_{SS} = 0\text{ V}$; $V_{DD}, V_{DDQ} = 3.3\text{V} \pm 0.3\text{V}$

Symbol	Parameter	Limit Values		Unit
		Min.	Max.	
V_{IH}	Input High Voltage	2.0	$V_{CC}+0.3$	V
V_{IL}	Input Low Voltage	-0.5	0.8	V
V_{OH}	Output High Voltage ($I_{OUT} = -2.0\text{ mA}$)	2.4	—	V
V_{OL}	Output Low Voltage ($I_{OUT} = 2.0\text{ mA}$)	—	0.4	V

Symbol	Parameter	Limit Values		Unit
		Min.	Max.	
$I_{I(L)}$	Input Leakage Current, any input ($0\text{ V} < V_{IN} < 3.6\text{ V}$, all other inputs = 0V)	-40	40	μA
$I_{O(L)}$	Output leakage current (DQ is disabled, $0\text{V} < V_{OUT} < V_{CC}$)	-40	40	μA

Capacitance

$T_A = 0^\circ\text{C}$ to 70°C ; $V_{DD} = 3.3\text{V} \pm 0.3\text{V}$, $f = 1\text{ MHz}$

Symbol	Parameter	Limit Values	Unit
		Max. 16M x 64	
C_{I1}	Input Capacitance (A0 to A11, $\overline{\text{RAS}}$, $\overline{\text{CAS}}$, $\overline{\text{WE}}$)	60	pF
C_{I2}	Input Capacitance ($\overline{\text{CS0}}$ - $\overline{\text{CS3}}$)	30	pF
C_{ICL}	Input Capacitance (CLK0-CLK3)	22	pF
C_{I3}	Input Capacitance (CKE0, CKE1)	50	pF
C_{I4}	Input Capacitance (DQM0-DQM7)	15	pF
C_{IO}	Input/Output Capacitance (I/O1-I/O64)	15	pF
C_{SC}	Input Capacitance (SCL, SA0-2)	8	pF
C_{SD}	Input/Output Capacitance (SA0-SA2)	10	pF

Absolute Maximum Ratings

Parameter	Max.	Units
Voltage on VDD Supply Relative to V_{SS}	-1 to 4.6	V
Voltage on Input Relative to V_{SS}	-1 to 4.6	V
Operating Temperature	0 to +70	$^\circ\text{C}$
Storage Temperature	-55 to 125	$^\circ\text{C}$
Power Dissipation	6.0	W

Operating Currents

$T_A = 0^{\circ}\text{C}$ to 70°C , $V_{CC} = 3.3\text{V} \pm 0.3\text{V}$ (Recommended operating conditions otherwise noted)

Symbol	Parameter & Test Condition		Max.		Unit	Note
			-75PC /-75	-10PC		
ICC1	Operating Current $t_{RC} = t_{RCMIN.}$, $t_{CK} = t_{CKMIN.}$ Active-precharge command cycling, without Burst Operation	1 bank operation	680	600	mA	7
ICC2P	Precharge Standby Current in Power Down Mode $\overline{CS} = V_{IH}$, $CKE \leq V_{IL(max)}$	$t_{CK} = \text{min.}$	12	12	mA	7
ICC2PS		$t_{CK} = \text{Infinity}$	8	8	mA	7
ICC2N	Precharge Standby Current in Non-Power Down Mode $\overline{CS} = V_{IH}$, $CKE \geq V_{IL(max)}$	$t_{CK} = \text{min.}$	180	140	mA	
ICC2NS		$t_{CK} = \text{Infinity}$	20	20	mA	
ICC3N	No Operating Current $t_{CK} = \text{min.}$, $\overline{CS} = V_{IH(min)}$	$CKE \geq V_{IH(MIN.)}$	220	180	mA	
ICC3P	bank ; active state (4 banks)	$CKE \leq V_{IL(MAX.)}$ (Power down mode)	80	80	mA	
ICC4	Burst Operating Current $t_{CK} = \text{min}$ Read/Write command cycling		440	360	mA	7,8
ICC5	Auto Refresh Current $t_{CK} = \text{min}$ Auto Refresh command cycling		1850	1680	mA	7
ICC6	Self Refresh Current Self Refresh Mode, $CKE = < 0.2\text{V}$		12	12	mA	
		L-version	6.4	6.4	mA	

Notes:

1. These parameters depend on the cycle rate and these values are measured by the cycle rate under the minimum value of t_{CK} and t_{RC} . Input signals are changed one time during t_{CK} .
2. These parameter depend on output loading. Specified values are obtained with output open.

AC Characteristics ^{3,4}

$T_A = 0^\circ$ to 70°C ; $V_{SS} = 0\text{V}$; $V_{CC} = 3.3\text{V} \pm 0.3\text{V}$, $t_T = 1\text{ ns}$

#	Symbol	Parameter	Limit Values						Unit	Note
			-75PC		-75		-10PC			
			Min.	Max.	Min.	Max.	Min.	Max.		
Clock and Clock Enable										
1	t_{CK}	Clock Cycle Time CAS Latency = 3 CAS Latency = 2	7.5 7.5		7.5 10		10 10		ns ns	
2	f_{CK}	System frequency CAS Latency = 3 CAS Latency = 2	- -	133 133	- -	133 100	- -	100 100	MHz MHz	
3	t_{AC}	Clock Access Time CAS Latency = 3 CAS Latency = 2	- -	5.4 6	- -	5.4 6	- -	6 6	ns ns	4,5
4	t_{CH}	Clock High Pulse Width	2.5	-	2.5	-	3	-	ns	6
5	t_{CL}	Clock Low Pulse Width	2.5	-	2.5	-	3	-	ns	6
6	t_{CS}	Input Setup time	1.5	-	1.5	-	2	-	ns	7
7	t_{CH}	Input Hold Time	0.8	-	0.8	-	1	-	ns	7
8	t_{CKSP}	CKE Setup Time (Power down mode)	2	-	2	-	2	-	ns	8
9	t_{CKSR}	CKE Setup Time (Self Refresh Exit)	8	-	8	-	8	-	ns	9
10	t_T	Transition time (rise and fall)	1	-	1	-	1	-	ns	
Common Parameters										
11	t_{RCD}	RAS to CAS delay	15	-	20	-	20	-	ns	
12	t_{RC}	Cycle Time	70	120k	70	120k	70	120k	ns	
13	t_{RAS}	Active Command Period	42	-	45	-	45	-	ns	
14	t_{RP}	Precharge Time	15	-	20	-	20	-	ns	
15	t_{RRD}	Bank to Bank Delay Time	14	-	15	-	20	-	ns	
16	t_{CCD}	CAS to CAS delay time (same bank)	1	-	1	-	1	-	CLK	
Refresh Cycle										
17	t_{SREX}	Self Refresh Exit Time	10	-	10	-	10	-	ns	9
18	t_{REF}	Refresh Period (4096 cycles)	64	-	64	-	64	-	ms	8
Read Cycle										
19	t_{OH}	Data Out Hold Time	3	-	3	-	3	-	ns	4
20	t_{LZ}	Data Out to Low Impedance Time	0	-	0	-	0	-	ns	
21	t_{HZ}	Data Out to High Impedance Time	3	7.5	3	7.5	3	8	ns	10
22	t_{DQZ}	DQM Data Out Disable Latency	2	-	2	-	2	-	CLK	
Write Cycle										
23	t_{DPL}	Data input to Precharge (write recovery)	1	-	1	-	1	-	CLK	
24	t_{DAL}	Data In to Active/refresh	5	-	5	-	5	-	CLK	11
25	t_{DQW}	DQM Write Mask Latency	0	-	0	-	0	-	CLK	

Notes:

1. The specified values are valid when addresses are changed no more than once during $t_{CK}(\text{min.})$ and when No Operation commands are registered on every rising clock edge during $t_{RC}(\text{min.})$. Values are shown per module bank.
2. The specified values are valid when data inputs (DQ's) are stable during $t_{RC}(\text{min.})$.
3. All AC characteristics are shown for device level.
An initial pause of 100 μs is required after power-up, then a Precharge All Banks command must be given followed by 8 Auto Refresh (CBR) cycles before the Mode Register Set Operation can begin.
4. AC timing tests have $V_{IL} = 0.4\text{V}$ and $V_{IH} = 2.4\text{V}$ with the timing referenced to the 1.4V crossover point. The transition time is measured between V_{IH} and V_{IL} . All AC measurements assume $t_T = 1 \text{ ns}$ with the AC output load circuit shown. Specific t_{ac} and t_{oh} parameters are measured with a 50 pF only, without any resistive termination and with a input signal of 1V / ns edge rate between 0.8V and 2.0V.

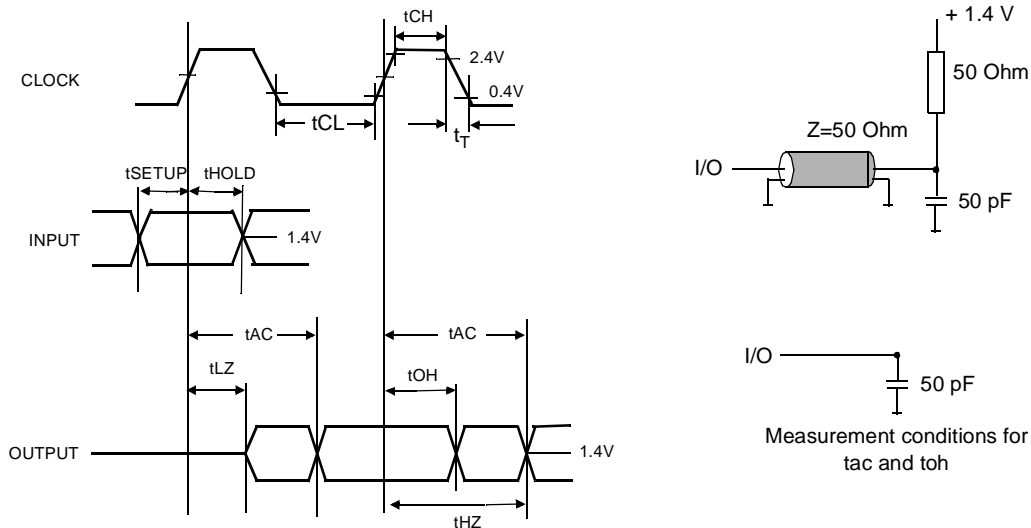

5. If clock rising time is longer than 1 ns, a time $(t_T/2 - 0.5)$ ns has to be added to this parameter.
6. Rated at 1.5V
7. If t_T is longer than 1 ns, a time $(t_T - 1)$ ns has to be added to this parameter.
8. Any time that the refresh Period has been exceeded, a minimum of two Auto (CBR) Refresh commands must be given to "wake-up" the device.
9. Self Refresh Exit is a synchronous operation and begins on the 2nd positive clock edge after CKE returns high. Self Refresh Exit is not complete until a time period equal to t_{RC} is satisfied once the Self Refresh Exit command is registered.
10. Referenced to the time which the output achieves the open circuit condition, not to output voltage levels.
11. t_{DAL} is equivalent to $t_{DPL} + t_{RP}$.

Package Diagram
SDRAM DIMM LOW-PROFILE Module Package

Units : Inches (Millimeters)

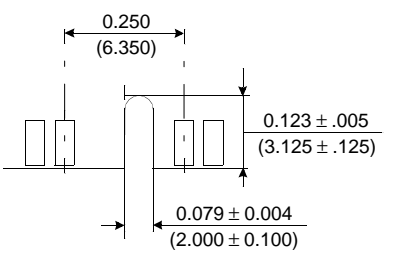
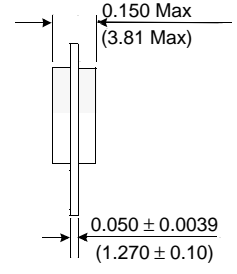
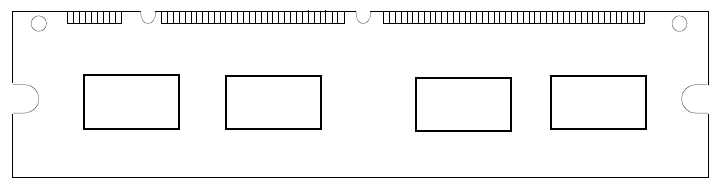
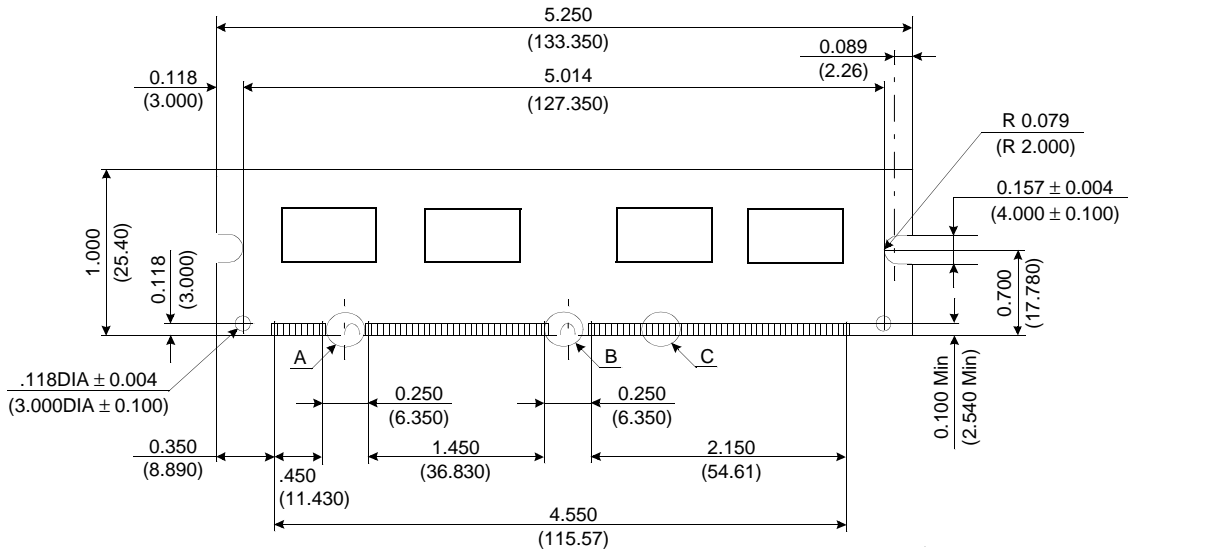

Detail A

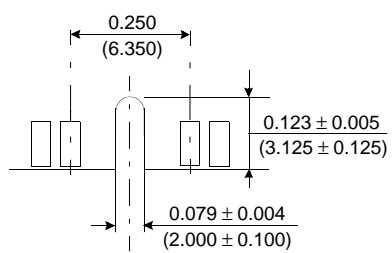

Detail B

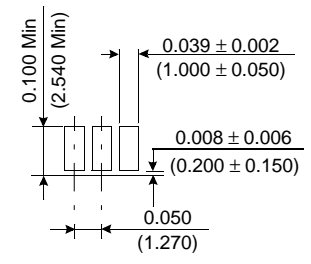

Detail C

Tolerance: + 0.005(.13) unless otherwise specified

Label Information

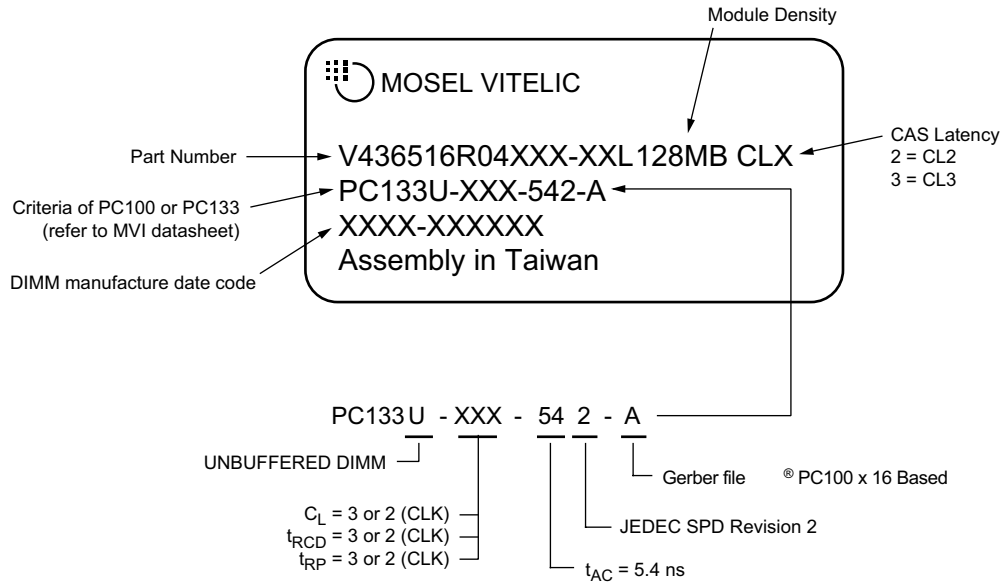

U.S.A.

3910 NORTH FIRST STREET
SAN JOSE, CA 95134
PHONE: 408-433-6000
FAX: 408-433-0952

TAIWAN

7F, NO. 102
MIN-CHUAN E. ROAD, SEC. 3
TAIPEI
PHONE: 886-2-2545-1213
FAX: 886-2-2545-1209

NO 19 LI HSIN ROAD
SCIENCE BASED IND. PARK
HSIN CHU, TAIWAN, R.O.C.
PHONE: 886-3-579-5888
FAX: 886-3-566-5888

SINGAPORE

10 ANSON ROAD #23-13
INTERNATIONAL PLAZA
SINGAPORE 079903
PHONE: 65-3231801
FAX: 65-3237013

JAPAN

ONZE 1852 BUILDING 6F
2-14-6 SHINTOMI, CHUO-KU
TOKYO 104-0041
PHONE: 03-3537-1400
FAX: 03-3537-1402

UK & IRELAND

SUITE 50, GROVEWOOD
BUSINESS CENTRE
STRATHCLYDE BUSINESS
PARK
BELLSHILL, LANARKSHIRE,
SCOTLAND, ML4 3NQ
PHONE: 44-1698-748515
FAX: 44-1698-748516

**GERMANY
(CONTINENTAL
EUROPE & ISRAEL)**

BENZSTRASSE 32
71083 HERRENBERG
GERMANY
PHONE: +49 7032 2796-0
FAX: +49 7032 2796 22

U.S. SALES OFFICES**NORTHWESTERN**

3910 NORTH FIRST STREET
SAN JOSE, CA 95134
PHONE: 408-433-6000
FAX: 408-433-0952

SOUTHWESTERN

302 N. EL CAMINO REAL #200
SAN CLEMENTE, CA 92672
PHONE: 949-361-7873
FAX: 949-361-7807

**CENTRAL,
NORTHEASTERN &
SOUTHEASTERN**

604 FIELDWOOD CIRCLE
RICHARDSON, TX 75081
PHONE: 214-352-3775
FAX: 214-904-9029

The information in this document is subject to change without notice.

MOSEL VITELIC makes no commitment to update or keep current the information contained in this document. No part of this document may be copied or reproduced in any form or by any means without the prior written consent of MOSEL-VITELIC.

MOSEL VITELIC subjects its products to normal quality control sampling techniques which are intended to provide an assurance of high quality products suitable for usual commercial applications. MOSEL VITELIC does not do testing appropriate to provide 100% product quality assurance and does not assume any liability for consequential or incidental arising from any use of its products. If such products are to be used in applications in which personal injury might occur from failure, purchaser must do its own quality assurance testing appropriate to such applications.