

General

The 3G3MV is a sensorless flux vector control inverter for power sizes up to 7.5 kW. Vector control provides improved speed holding and motor torque at low speeds, without the need for an encoder feedback signal. To enable the 3G3MV to be integrated into systems, there are configurable digital I/O, configurable analogue I/O plus all digital I/O can be wired in NPN or PNP.

Characteristics:

- Power range 0.1..7.5 kW
- Sensorless vector controlled inverter
- Compact size
- Frequency setting signal 0..10 V / 4..20 mA
- 150% overload / 60 sec
- 100% torques at 0.5 Hz
- Customised application software
- Overload detection
- Pulse input
- Programmable second analogue input
- Integrated PID controller
- 16 programmable fixed frequencies
- DC injection
- In-built operator/copy unit
- Optional field bus modules (DeviceNet, PROFIBUS, CANopen, Interbus-S)
- True PLC functionality as option
- PC configuration tool SYSDRIVE Configurator
- Approvals: CE, UL, c-UL



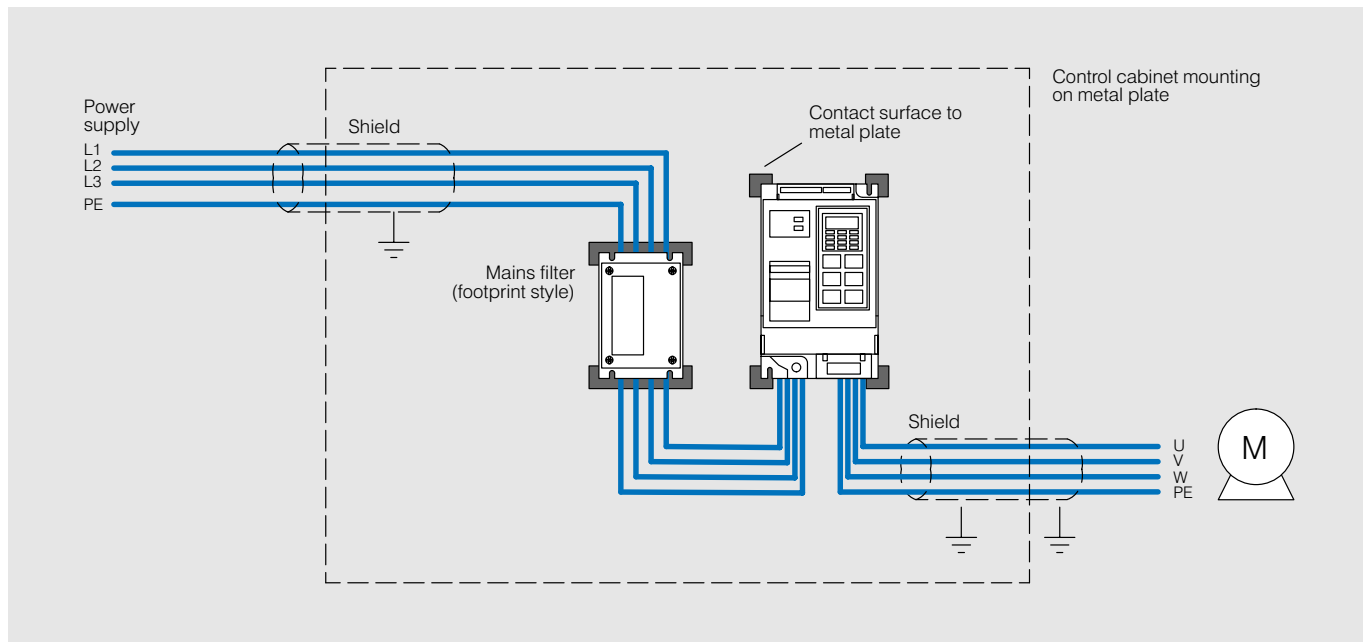

System Configuration

In order to conform to the applicable EMC directives, it is necessary to fit suitable EMC filters and follow the installation guidelines given.



Product Overview

	Max. motor output	Output current	Model code
Single-phase 230 V			
	0.12 kW	0.8 A	3G3MV-AB001
	0.25 kW	1.5 A	3G3MV-AB002
	0.55 kW	3.0 A	3G3MV-AB004
	1.1 kW	5.0 A	3G3MV-AB007
	1.5 kW	8.0 A	3G3MV-AB015
	2.2 kW	11 A	3G3MV-AB022
	4.0 kW	17.5 A	3G3MV-AB040
Three-phase 230 V			
	0.12 kW	0.8 A	3G3MV-A2001
	0.25 kW	1.5 A	3G3MV-A2002
	0.55 kW	3.0 A	3G3MV-A2004
	1.1 kW	5.0 A	3G3MV-A2007
	1.5 kW	8.0 A	3G3MV-A2015
	2.2 kW	11 A	3G3MV-A2022
	4.0 kW	17.5 A	3G3MV-A2040
Three-phase 400 V			
	0.25 kW	1.2 A	3G3MV-A4002
	0.55 kW	1.8 A	3G3MV-A4004
	1.1 kW	3.4 A	3G3MV-A4007
	1.5 kW	4.8 A	3G3MV-A4015
	2.2 kW	5.5 A	3G3MV-A4022
	3.0 kW	7.2 A	3G3MV-A4030
	4.0 kW	9.2 A	3G3MV-A4040
	5.5 kW	14.8 A	3G3MV-A4055
	7.5 kW	18.0 A	3G3MV-A4075

Accessories

Mains filter, braking resistors, ferrite rings

Inverter	Model code			
	Mains filter (footprint style)	Braking resistors (3% ED)	Braking resistors (10% ED)	Ferrite rings
AB001	3G3MV-PFI1010-E	3G3IV-PERF150WJ401 (400 Ω)	-	3G3IV-PFO OC/1
AB002	3G3MV-PFI1010-E	3G3IV-PERF150WJ401 (400 Ω)	-	3G3IV-PFO OC/1
AB004	3G3MV-PFI1010-E	3G3IV-PERF150WJ201 (200 Ω)	-	3G3IV-PFO OC/1
AB007	3G3MV-PFI1020-E	3G3IV-PERF150WJ201 (200 Ω)	-	3G3IV-PFO OC/1
AB015	3G3MV-PFI1020-E	3G3IV-PERF150WJ101 (100 Ω)	-	3G3IV-PFO OC/1
AB022	3G3MV-PFI1030-E	3G3IV-PERF150WJ700 (70 Ω)	-	3G3IV-PFO OC/1
AB040	3G3MV-PFI1040-E	3G3IV-PERF150WJ620 (62 Ω)	-	3G3IV-PFO OC/2
A2001	3G3MV-PFI2010-E	3G3IV-PERF150WJ401 (400 Ω)	-	3G3IV-PFO OC/1
A2002	3G3MV-PFI2010-E	3G3IV-PERF150WJ401 (400 Ω)	-	3G3IV-PFO OC/1
A2004	3G3MV-PFI2010-E	3G3IV-PERF150WJ201 (200 Ω)	-	3G3IV-PFO OC/1
A2007	3G3MV-PFI2010-E	3G3IV-PERF150WJ201 (200 Ω)	-	3G3IV-PFO OC/1
A2015	3G3MV-PFI2020-E	3G3IV-PERF150WJ101 (100 Ω)	-	3G3IV-PFO OC/1
A2022	3G3MV-PFI2020-E	3G3IV-PERF150WJ700 (70 Ω)	-	3G3IV-PFO OC/1
A2040	3G3MV-PFI2030-E	3G3IV-PERF150WJ620 (62 Ω)	-	3G3IV-PFO OC/2

Accessories (Continued)

Mains filter, braking resistors, ferrite rings (Continued)

Inverter	Model code			
	Mains filter (footprint style)	Braking resistors (3% ED)	Braking resistors (10% ED)	Ferrite rings
A4002	3G3MV-PFI3005-E	3G3IV-PERF150WJ751 (750 Ω)	-	3G3IV-PFO OC/1
A4004	3G3MV-PFI3005-E	3G3IV-PERF150WJ751 (750 Ω)	-	3G3IV-PFO OC/1
A4007	3G3MV-PFI3010-E	3G3IV-PERF150WJ751 (750 Ω)	-	3G3IV-PFO OC/1
A4015	3G3MV-PFI3010-E	3G3IV-PERF150WJ401 (400 Ω)	3G3IV-PLKEB41P5 (400 Ω)	3G3IV-PFO OC/1
A4022	3G3MV-PFI3010-E	3G3IV-PERF150WJ301 (300 Ω)	3G3IV-PLKEB42P2 (250 Ω)	3G3IV-PFO OC/1
A4030	3G3MV-PFI3020-E	2x 3G3IV-PERF150WJ401 (200 Ω)	3G3IV-PLKEB43P7 (150 Ω)	3G3IV-PFO OC/2
A4040	3G3MV-PFI3020-E	2x 3G3IV-PERF150WJ301 (150 Ω)	3G3IV-PLKEB43P7 (150 Ω)	3G3IV-PFO OC/2
A4055	3G3MV-PFI3030-E	-	3G3IV-PLKEB45P5 (100 Ω)	3G3IV-PFO OC/2
A4075	3G3MV-PFI3030-E	-	3G3IV-PLKEB47P5 (75 Ω)	3G3IV-PFO OC/2

Other accessories

Description	Cable length	Model code
Connecting cable for 2nd analogue input	-	3G3MV-PCN-CN2
DIN track adapter for installation without mains filter	-	3G3EV-PSPAT3 (<1.1 kW single-phase)
	-	3G3EV-PSPAT4 (>1.1 kW single-phase, 0.25..2.2 kW three-phase)

Option cards



Description	Model code
Option cards for DeviceNet	3G3MV-PDRT-SINV1
Option cards for: - CANopen - Interbus S - PROFIBUS-DP	On request

Programming and Documentation

Programming

Description	Cable length	Model code
SYSDRIVE Configurator. Programming software for Frequency Inverter. For WINDOWS 95/98/NT4.0 - see page 456	-	SYSDRIVE Configurator
Connecting cable <-> PC	3 m	3G3IV-PCN329-E

Technical Documentation

English documentation	Product	Title	Model code
	3G3MV	User Manual	I527-E2

Specifications

230 V class

		AB001	AB002	AB004	AB007	AB015	AB022	AB040	
		A2001	A2002	A2004	A2007	A2015	A2022	A2040	
Single-phase: 3G3MV-__									
Three-phase: 3G3MV-__									
Maximum permissible motor output	kW	0.12	0.25	0.55	1.1	1.5	2.2	4.0	
Output data	Inverter rating	kVA	0.3	0.6	1.1	1.9	3.0	4.2	6.7
	Rated output current	A	0.8	1.6	3.0	5.0	8.0	11.0	17.5
	Max. output voltage	Proportional to input voltage: 0..240 V							
	Output frequencies	0.1..400 Hz							
Supply	Rated input voltage and frequency	200..240 VAC, 50/60 Hz							
	Max. voltage deviation	-15%..+10%							
	Max. frequency deviation	+5%							
Weight	kg	0.5	0.5	0.5	0.8	0.8	1.3	1.5	

400 V class

		A4002	A4004	A4007	A4015	A4022	A4030	A4040	A4055	A4075	
Three-phase: 3G3MV-__											
Maximum permissible motor output	kW	0.25	0.55	1.1	1.5	2.2	3.0	4.0	5.5	7.5	
Output data	Inverter rating	kVA	0.9	1.4	2.6	3.7	4.2	5.5	7.0	11.0	13.8
	Rated output current	A	1.2	1.8	3.4	4.8	5.5	7.2	9.2	14.8	18.0
	Max. output voltage	Proportional to input voltage: 0..400 V									
	Output frequencies	0.1..400 Hz									
Supply	Rated input voltage and frequency	380..460 VAC, 50/60 Hz									
	Max. voltage deviation	-15%..+10%									
	Max. frequency deviation	+5%									
Weight	kg	1.3	1.3	1.3	1.3	1.5	2.0	2.0	2.0	2.0	

Specifications (Continued)

General data

Control functions	Control methods	Sinus PWM, switchable between V/f and voltage vector control
	Output frequency range	0.1..400 Hz
	Frequency tolerance	Digital set value: $\pm 0.01\%$ ($-10..+50^{\circ}\text{C}$)
		Analogue set value: $\pm 0.5\%$ ($25 \pm 10^{\circ}\text{C}$)
	Resolution of frequency set value	Digital set value: 0.01 Hz (<100 Hz), 0.1 Hz (>100 Hz)
		Analogue set value: 1/1000 of maximum frequency
	Resolution of output frequency	0.01 Hz
	Overload capability	150%/60 s
	Frequency set value	0..10 V (20 k Ω), 4..20 mA (250 Ω), 0..20 mA (250 Ω)
	Braking torque (short term peak torques)	Pulse signal
Up to 200 W		150%
550 W, 1.1 kW		100%
1.5 kW		50%
>1.5 kW		20%
Continuous braking torque approx. 20% without, 150% with external braking resistor		
Protection functions	Motor overload protection	Electronically adjustable motor protection
	Short-term peak current	Fault switch off at 250% motor current
	Overload	Fault switch off at 150% rated current after 60 s
	Overvoltage	Fault tripping at 410 V (820 V for 400V types) intermediate circuit voltage
	Undervoltage	Fault tripping at 160 V (400 V for 400V types) intermediate circuit voltage
	Mains failure, adjustable	Fault switch off for failure >15 ms
		Fault switch off for failure >0.5 s
	No fault tripping	
	Excess temperature of heat sink	Electronic protection
	Stall prevention	Separately adjustable for braking, operation and acceleration
Fan monitoring	Electronic stall prevention	
Earth fault	Electronic protection (earth current monitoring)	
Functionality	Binary inputs	7 freely programmable inputs
	Binary outputs	1 relay output, 2 freely programmable open collector outputs
	Analogue output	1 programmable analogue output (0..10 V)/pulse output
	Analogue inputs	2 analogue inputs, 0..10 V, 4..20 mA, 0..20 mA
	Braking/acceleration times	0.01..6000 s
	Display	Optionally frequency, current or set value Error and status LED
Ambient conditions	Degree of protection	IP20, wall mounting
	Cooling	Cooling fan for 0.75 kW (200 V), 1.5 kW (400 V)
	Ambient temperature	Open air mounting: $-10^{\circ}\text{C}..50^{\circ}\text{C}$
		Wall mounting: $-10^{\circ}\text{C}..40^{\circ}\text{C}$
	Ambient humidity	95% (without condensation)
	Storage temperature	$-20^{\circ}\text{C}..+60^{\circ}\text{C}$
	Installation	In control cabinet, free of dust and corrosive gases
	Installation height	Max. 1000 m
Vibrations	1 g at <20 Hz, 0.2 g at <50 Hz	

Connection Diagram

(On single-phase devices, L3 remains free)

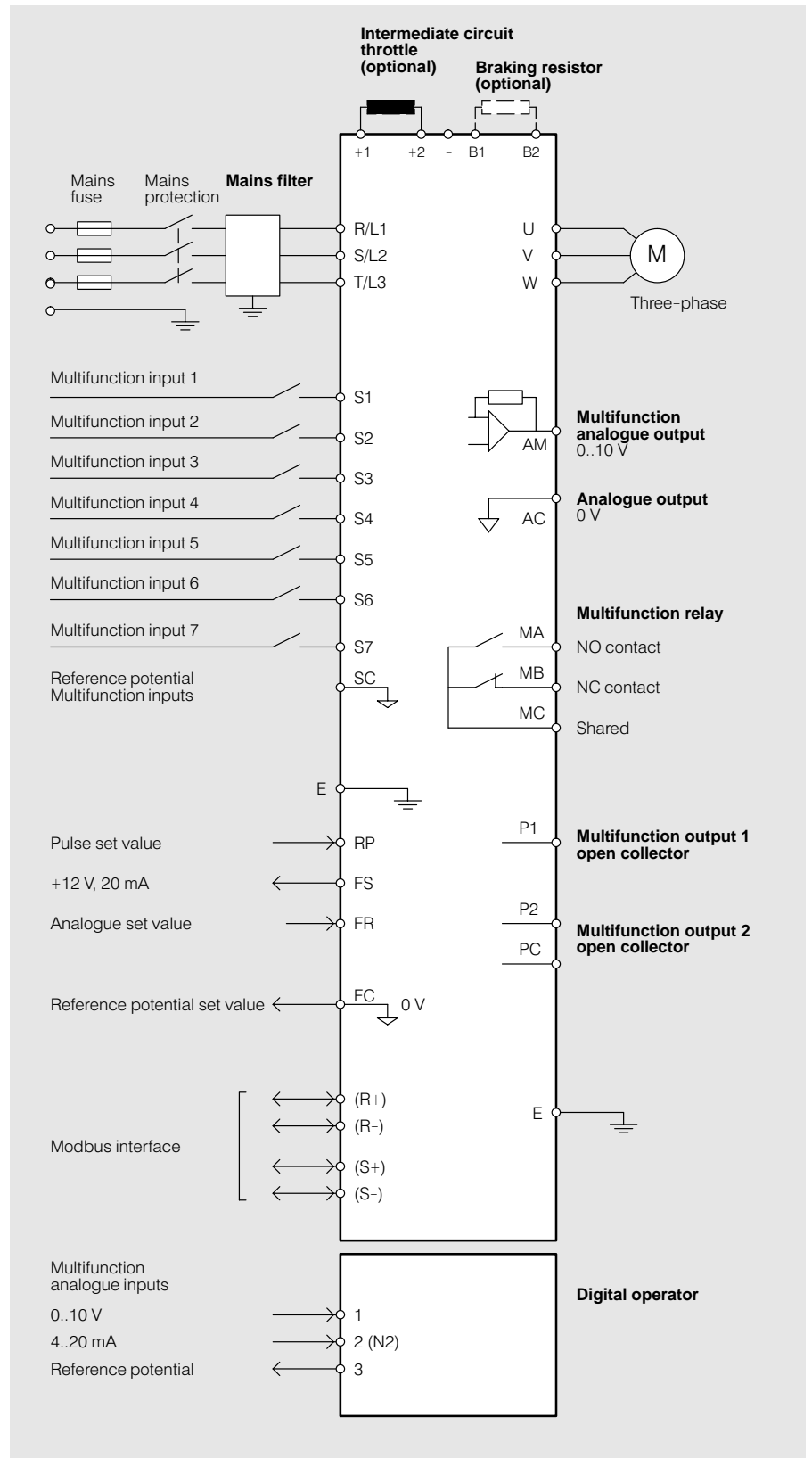

Dimensions (mm)

3G3MV-AB_

W	W1	D	Fig.	Model code
68	56	76	1	001
68	56	89	1	002
68	56	138	1	004
108	96	140	2	007
108	96	156	2	015
140	128	163	2	022
170	158	180	2	040

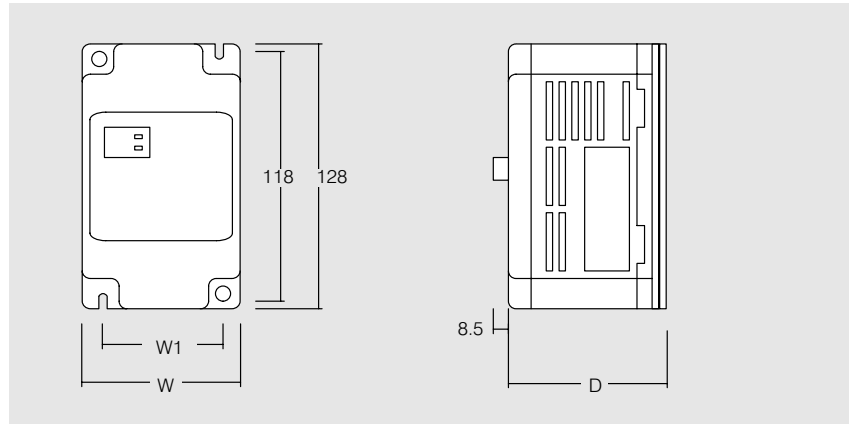

Figure 1

3G3MV-A2_

W	W1	D	Fig.	Model code
68	56	76	1	001
68	56	76	1	002
68	56	108	1	004
68	56	128	2	007
108	96	131	2	015
108	96	140	2	022
140	128	143	2	040

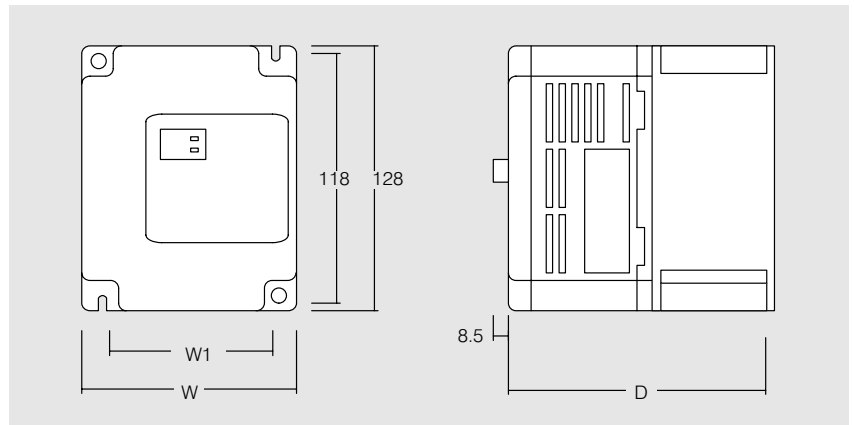
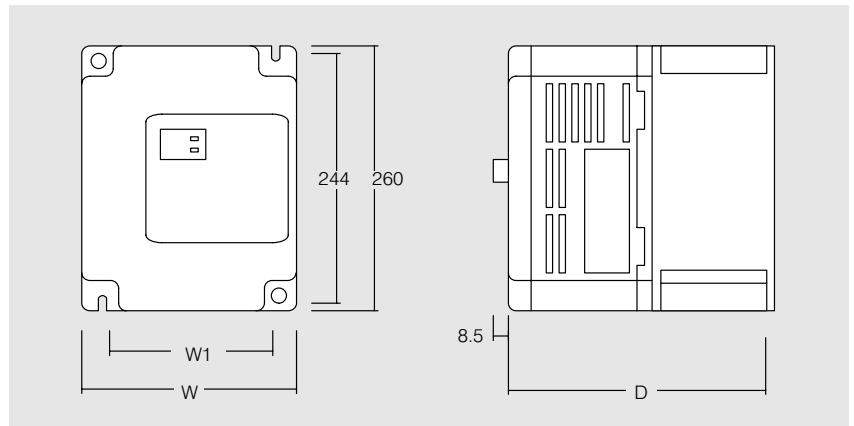

Figure 2

Dimensions (mm) (Continued)

3G3MV-A4_

W	W1	D	Model code
108	96	92	002
108	96	110	004
108	96	140	007
108	96	156	015
108	96	156	022
140	128	143	030
140	128	143	040
180	164	170	055
180	164	170	075



Mains filter 3G3MV-PFI_

W	W1	H	H1	D	Model code
71	51	169	156	45	1010-E
111	91	169	156	50	1020-E
144	120	174	161	50	1030-E
174	150	174	161	50	1040-E
82	62	194	181	50	2010-E
111	91	169	156	50	2020-E
144	120	174	161	50	2030-E
111	91	169	156	45	3005-E
111	91	169	156	45	3010-E
144	120	174	161	50	3020-E
184	150	304	288	56	3030-E

