



Frontier Electronics Corp.

667 E. COCHRAN STREET, SIMI VALLEY, CA 93065

TEL: (805) 522-9998 FAX: (805) 522-9989

E-mail: frontiersales@frontierusa.com

Web: <http://www.frontierusa.com>

3A FAST EFFICIENT SURFACE MOUNT RECTIFIER

ES3A-LFR THRU ES3J-LFR

FEATURES

- LOW PROFILE PACKAGE
- PLASTIC PACKAGE HAS UNDERWRITERS LABORATORY 94V-0
- IDEAL FOR SURFACE MOUNTED APPLICATION
- GLASS PASSIVATED CHIP JUNCTION
- BUILT-IN STRAIN RELIEF DESIGN
- 25nS FAST EFFICIENT RECOVERY TIME FOR HIGH EFFICIENT
- HIGH TEMPERATURE SOLDERING : 250°C/10 SECONDS AT TERMINALS
- ROHS

MECHANICAL DATA

- CASE: JEDEC DO-214AB (SMC), MOLDED PLASTIC BODY DIMENSIONS IN INCHES AND (MILLIMETERS)
- TERMINAL: SOLDER PLATED, SOLDERABLE PER MIL-STD-750 METHOD 2026
- POLARITY: COLOR BAND DENOTES CATHODE
- WEIGHT: 0.21 GRAMS

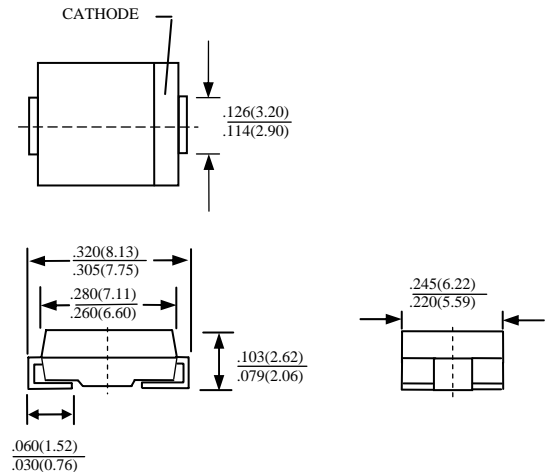

MAXIMUM RATINGS AND ELECTRICAL CHARACTERISTICS RATINGS AT 25°C AMBIENT TEMPERATURE UNLESS OTHERWISE SPECIFIED SINGLE PHASE, HALF WAVE, 60 HZ, RESISTIVE OR INDUCTIVE LOAD. FOR CAPACITIVE LOAD, DERATE CURRENT BY 20%

RATINGS	SYMBOL	ES3A-LFR	ES3B-LFR	ES3D-LFR	ES3E-LFR	ES3G-LFR	ES3J-LFR	UNITS
MAXIMUM RECURRENT PEAK REVERSE VOLTAGE	V_{RRM}	50	100	200	300	400	600	V
MAXIMUM RMS VOLTAGE	V_{RMS}	35	70	140	210	280	420	V
MAXIMUM DC BLOCKING VOLTAGE	V_{DC}	50	100	200	300	400	600	V
MAXIMUM AVERAGE FORWARD RECTIFIED CURRENT AT $T_J=90^\circ\text{C}$	I_O	3.0						A
PEAK FORWARD SURGE CURRENT, 8.3ms SINGLE HALF SINE-WAVE SUPERIMPOSED ON RATED LOAD	I_{FSM}	100						A
TYPICAL JUNCTION CAPACITANCE (NOTE 1)	C_J	70						PF
TYPICAL THERMAL RESISTANCE (NOTE 2)	$R_{\theta JL}$	12						°C/W
STORAGE TEMPERATURE RANGE	T_{STG}	- 55 TO + 150						°C
OPERATING TEMPERATURE RANGE	T_{OP}	- 55 TO + 150						°C

ELECTRICAL CHARACTERISTICS ($A_T T_A = 25^\circ\text{C}$ UNLESS OTHERWISE NOTED)

CHARACTERISTICS	SYMBOL	ES3A-LFR	ES3B-LFR	ES3D-LFR	ES3E-LFR	ES3G-LFR	ES3J-LFR	UNITS
MAXIMUM FORWARD VOLTAGE AT I_O DC	V_F	0.98			1.25		1.75	V
MAXIMUM REVERSE CURRENT AT 25°C	I_R	5						μA
MAXIMUM REVERSE CURRENT AT 100°C	I_R	200						μA
MAXIMUM REVERSE RECOVERY TIME (NOTE 3)	T_{RR}	25						nS
MARKING		ES3A	ES3B	ES3D	ES3E	ES3G	ES3J	

- NOTE: 1. MEASURED AT 1 MHZ AND APPLIED REVERSE VOLTAGE OF 4.0 VOLTS
 2. THERMAL RESISTANCE FROM JUNCTION TO AMBIENT AND JUNCTION TO LEAD P.C.B. MOUNTED ON 0.3x0.3"(8.0x8.0mm) COPPER PAD AREAS
 3. REVERSE RECOVERY TEST CONDITIONS: $I_F=0.5\text{A}$, $I_R=1.0\text{A}$, $I_{RR}=0.25\text{A}$

RATINGS AND CHARACTERISTIC CURVE ES3A-LFR THRU ES3J-LFR

FIG. 1-TEST CIRCUIT DIAGRAM AND REVERSE RECOVERY TIME CHARACTERISTIC

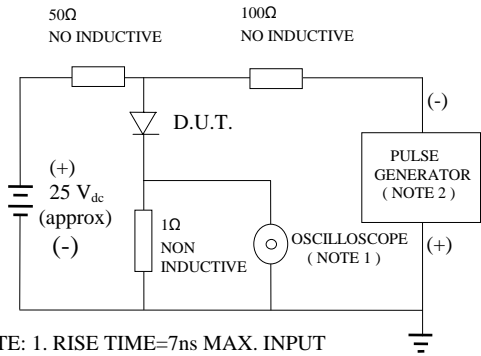

NOTE: 1. RISE TIME=7ns MAX. INPUT IMPEDANCE=1 MOhms 22PF
2. RISE TIME =10ns MAX. SOURCE IMPEDANCE=50 OHMS

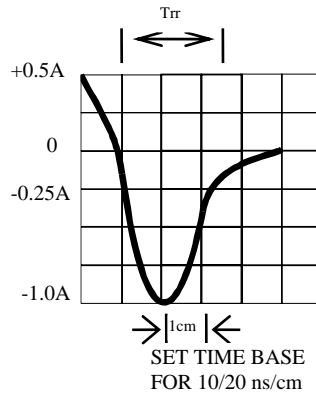

FIG. 2-TYPICAL FORWARD CURRENT DERATING CURVE

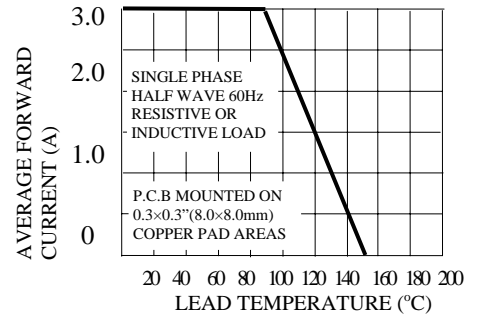

FIG. 3-TYPICAL REVERSE CHARACTERISTICS

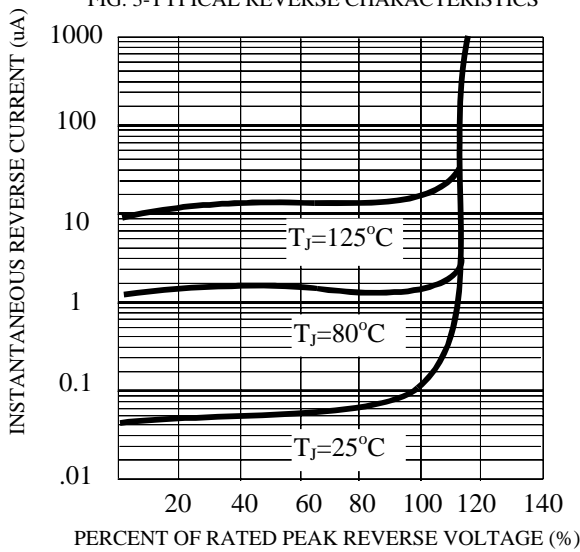

FIG. 4-TYPICAL INSTANTANEOUS FORWARD CHARACTERISTICS

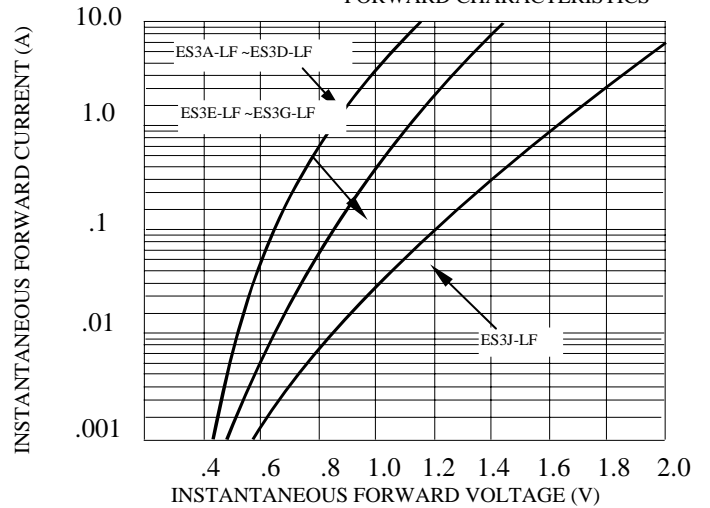

FIG. 5-MAXIMUM NON-REPETITIVE FORWARD SURGE CURRENT

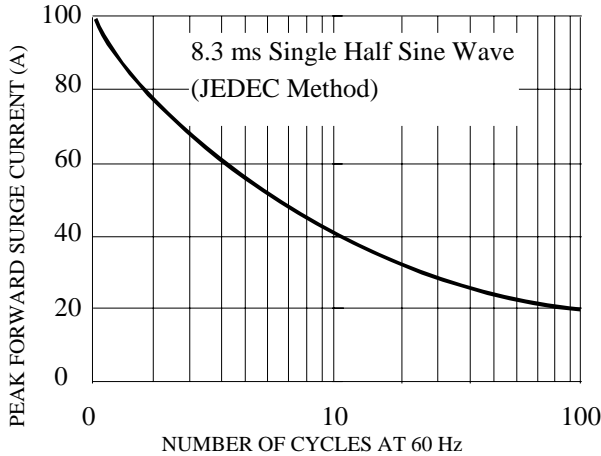

FIG. 6-TYPICAL JUNCTION CAPACITANCE

