

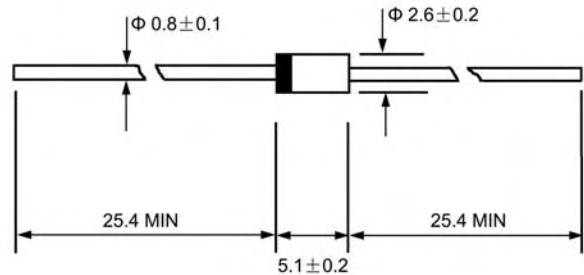

DO - 41

Dimensions in millimeters

Features

- ◇ Low cost
- ◇ Diffused junction
- ◇ Low leakage
- ◇ Low forward voltage drop
- ◇ High current capability
- ◇ Easily cleaned with alcohol, isopropanol and similar solvents
- ◇ The plastic material carries U/L recognition 94V-0

Mechanical Data

- ◇ Case: JEDEC DO-41, molded plastic
- ◇ Polarity: Color band denotes cathode
- ◇ Weight: 0.012 ounces, 0.34 grams
- ◇ Mounting position: Any

MAXIMUM RATINGS AND ELECTRICAL CHARACTERISTICS

Ratings at 25°C ambient temperature unless otherwise specified.

Single phase, half wave, 60 Hz, resistive or inductive load. For capacitive load, derate by 20%.

		ERA38 - 04	ERA38 - 05	ERA38 - 06	UNITS
Maximum recurrent peak reverse voltage	V_{RRM}	400	500	600	V
Maximum RMS voltage	V_{RMS}	280	350	420	V
Maximum DC blocking voltage	V_{DC}	400	500	600	V
Maximum average forward rectified current 9.5mm lead length, @ $T_A=75^\circ\text{C}$	$I_{F(AV)}$	0.5			A
Peak forward surge current 8.3ms single half-sine-wave superimposed on rated load @ $T_J=125^\circ\text{C}$	I_{FSM}	10.0			A
Maximum instantaneous forward voltage @ 0.5A	V_F	2.50			V
Maximum reverse current @ $T_A=25^\circ\text{C}$ at rated DC blocking voltage @ $T_A=100^\circ\text{C}$	I_R	5.0 50.0			μA
Maximum reverse recovery time (Note1)	t_{rr}	50			ns
Typical junction capacitance (Note2)	C_J	20	15		pF
Typical thermal resistance (Note3)	$R_{\theta JA}$	60			$^\circ\text{C/W}$
Operating junction temperature range	T_J	- 55 ----- + 150			$^\circ\text{C}$
Storage temperature range	T_{STG}	- 55 ----- + 150			$^\circ\text{C}$

 NOTE: 1. Measured with $I_F=0.5\text{A}$, $I_R=1\text{A}$, $t_{rr}=0.25\text{A}$.

2. Measured at 1.0MHz and applied reverse voltage of 4.0V DC.

3. Thermal resistance from junction to ambient.

Ratings AND Characteristic Curves

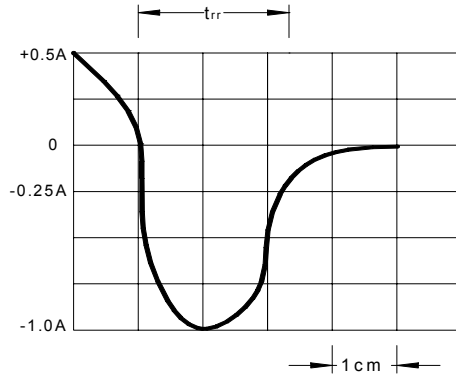
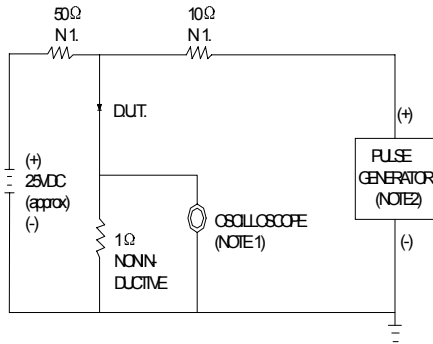
FIG.1--TEST CIRCUIT DIAGRAM AND REVERSE RECOVERY TIME CHARACTERISTIC

NOTES: 1. RISE TIME=7ns MAX. INPUT IMPEDANCE=1MΩ. 22pF
 2. RISE TIME=10ns MAX. SOURCE IMPEDANCE=50Ω.

SET TIME BASE FOR 20/30 ns/cm

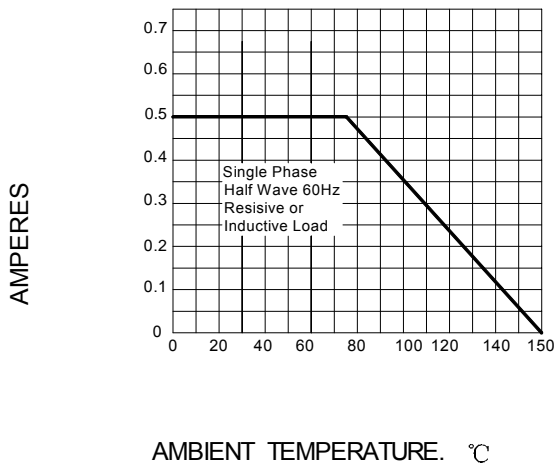
FIG.2 --FORWARD DERATING CURVE

AVERAGE FORWARD RECTIFIED CURRENT. AMPERES

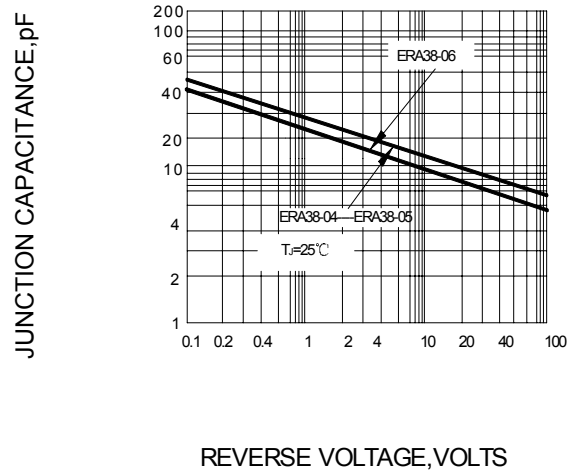
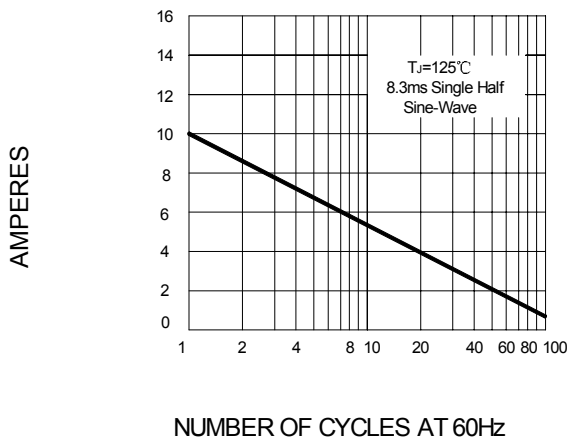
FIG.3--TYPICAL JUNCTION CAPACITANCE

FIG.4--PEAK FORWARD SURGE CURRENT

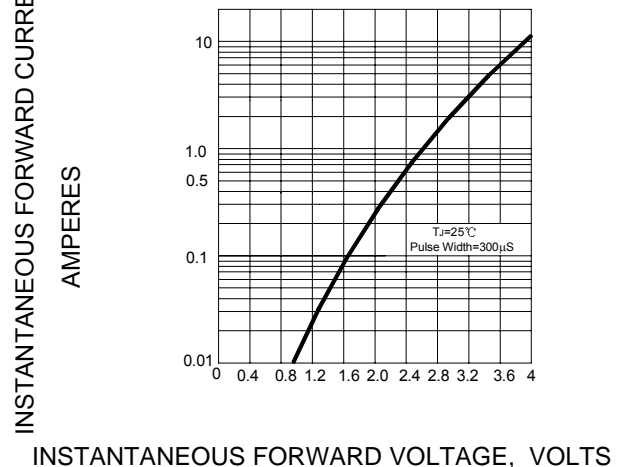
PEAK FORWARD SURGE CURRENT. AMPERES

FIG.5 -- TYPICAL FORWARD CHARACTERISTIC

INSTANTANEOUS FORWARD CURRENT AMPERES