

856731

192 MHz SAW Filter

Applications

- General Purpose Wireless
- Wireless Infrastructure
- 3G, 4G, Multistandard

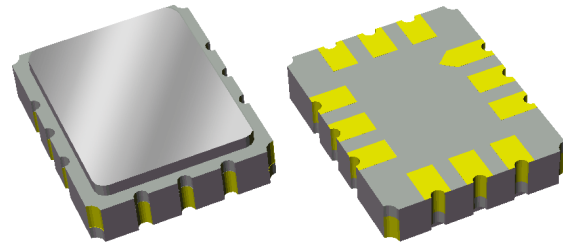

Functional Block Diagram SE/Bal

Top view

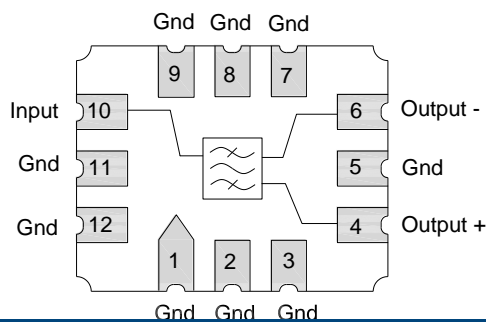

Functional Block Diagram SE/SE

Top view

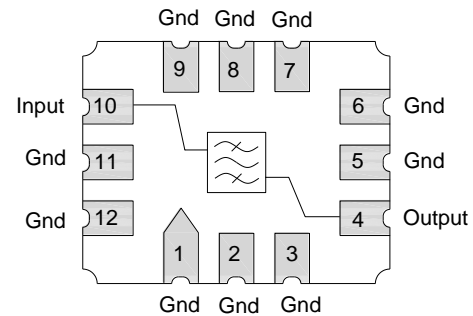

Product Features

- Usable bandwidth 60 MHz
- Low loss
- High attenuation
- Low EVM
- Single-Balanced or Single-Single ended operation
- Ceramic Surface Mount Package (SMP)
- Small Size: 7.01 x 5.51 x 1.70 mm
- Hermetic **RoHS** compliant, **Pb-free**

Pin Configuration

Pin #	SE/SE	Description
10		Input
4		Output
6		Ground
1,2,3,5,7,8,9,11,12		Case Ground

Pin #	SE/BAL	Description
10		Input
4		Output +
6		Output -
1,2,3,5,7,8,9,11,12		Case Ground

General Description

The 856731 is a high performance IF SAW filter developed for 4G and Multistandard infrastructure applications.

It features low loss coupled with excellent attenuation, and is designed to be used with multiple impedance values and configurations. The filter is developed for excellent in-band characteristics in order to minimize system bit-error rates.

This device is RoHS compliant and Pb-free.

Ordering Information

Part No.	Description
856731	packaged part
856731-EVB	evaluation board

Standard T/R size = 3000 units/reel.

Specifications

Electrical Specifications (1, 2)

Specified Temperature Range: ⁽³⁾ -40 to +85 °C

Parameter ⁽⁴⁾	Conditions	Min	Typical ⁽⁵⁾	Max	Units
Center Frequency		-	192	-	MHz
Insertion Loss	at 192 MHz	-	13.5	14.5	dB
Lower 3dB Bandedge ⁽⁷⁾		-	156.2	160.7	MHz
Upper 3dB Bandedge ⁽⁷⁾		223.3	227.9	-	MHz
Amplitude Variation ⁽⁶⁾	162 – 222 MHz	-	.5	1.0	dB p-p
Group Delay Variation ⁽⁶⁾	162 – 222 MHz	-	46	70	ns p-p
Relative Attenuation ⁽⁷⁾	10.0 – 105 MHz	45	53	-	dB
	105 – 132 MHz	40	44	-	dB
	132 – 148 MHz	38	42	-	dB
	238.5 – 245 MHz	40	45	-	dB
	245 – 300 MHz	40	49	-	dB
	300 – 455 MHz	45	56	-	dB
	455 – 555 MHz	43	46	-	dB
	555 – 705 MHz	50	55	-	dB
	705 – 1000 MHz	60	71	-	dB
Input/Output Return Loss	162 – 222 MHz	4.0	5	-	dB
Source Impedance (SE) ⁽⁸⁾		-	50	-	Ω
Load Impedance (SE) ⁽⁸⁾		-	50	-	Ω
Load Impedance (Bal) ⁽⁸⁾		-	150	-	Ω

Notes:

1. All specifications are based on the TriQuint schematic for the main reference designs shown on page 3 and 5
2. An external impedance matching network with $\pm 2\%$ tolerance will be necessary to achieve the proposed specifications
3. In production, devices will be tested at room temperature to a guardbanded specification to ensure electrical compliance over temperature
4. Electrical margin has been built into the design to account for the variations due to temperature drift and manufacturing tolerances
5. Typical values are based on average measurements at room temperature
6. These Variations are defined as the difference between the lowest loss and the highest loss within the defined frequency points
7. Relative to insertion loss at center frequency
8. This is the optimum impedance in order to achieve the performance shown

Absolute Maximum Ratings

Parameter	Rating
Operating Temperature	-40 to +85 °C
Storage Temperature	-40 to +85 °C
Input Power (at +55°C for > 29,500 hours max)	+15 dBm

Operation of this device outside the parameter ranges given above may cause permanent damage.

Reference Design – 50Ω SE Input, 50Ω SE Output

Schematic

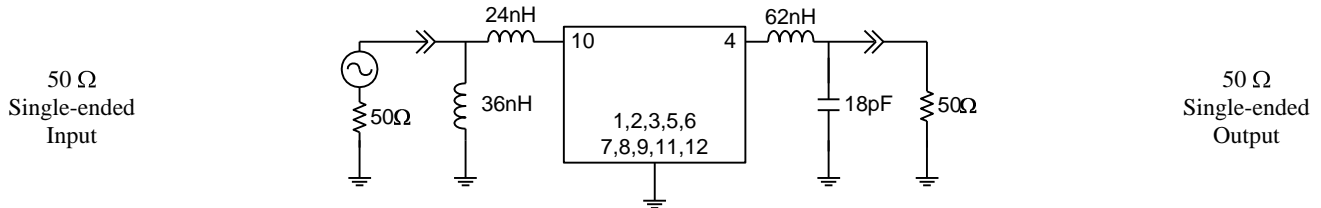

Notes:

- Actual matching values may vary due to PCB layout and parasitic

PC Board

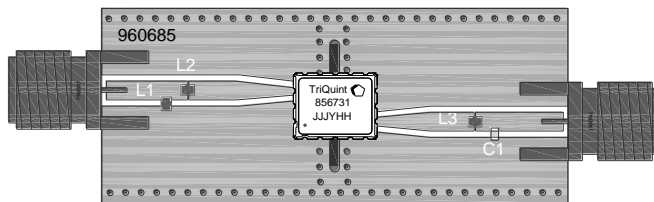

Notes:

- Top, middle & bottom layers: 1 oz copper
- Substrates: FR4 dielectric, .031" thick
- Finish plating: Nickel: 3-8μm thick, Gold: .03-.2μm thick
- Hole plating: Copper min .0008μm thick

Mounting Configuration

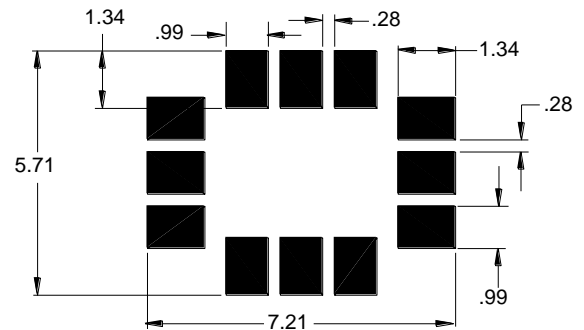

Notes:

- All dimensions are in millimeters.
- This footprint represents a recommendation only.

Bill of Material

Reference Desg.	Value	Description	Manufacturer	Part Number
L1	36nH	Coil Wire-wound, 0603, 5%	MuRata	LQW18AN36NJ00
L2	24nH	Coil Wire-wound, 0603, 5%	MuRata	LQW18AN24NJ00
L3	62nH	Coil Wire-wound, 0603, 5%	MuRata	LQW18AN62NJ00
C1	18pF	Chip Ceramic, 0603, 5%	MuRata	GRM1885C1H180JA01
SMA	N/A	SMA connector	Johnson Components	142-0701-801
PCB	N/A	3-layer	multiple	960686

Typical Performance SE/SE₂(at room temperature)

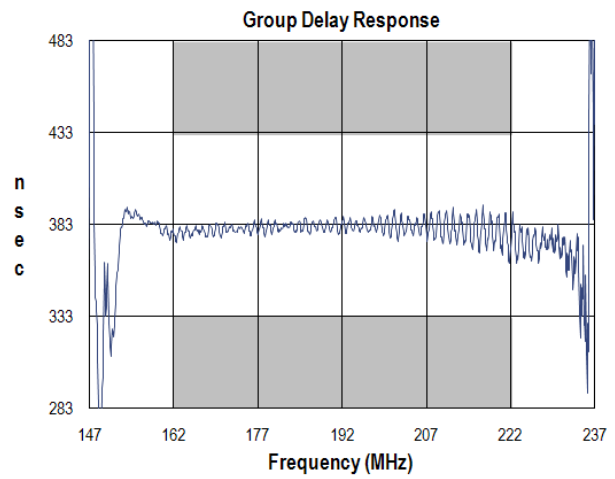
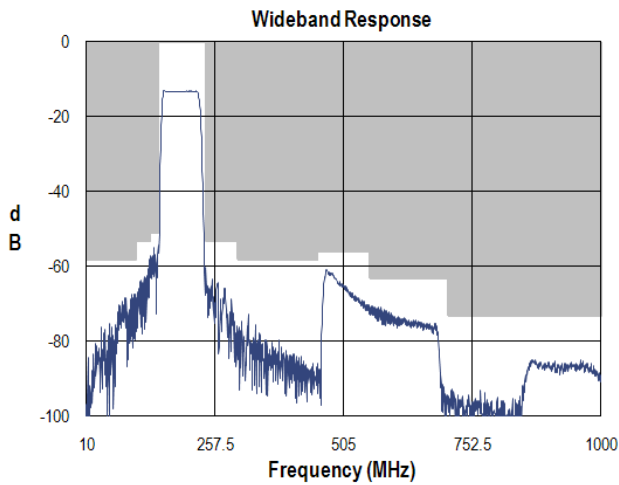
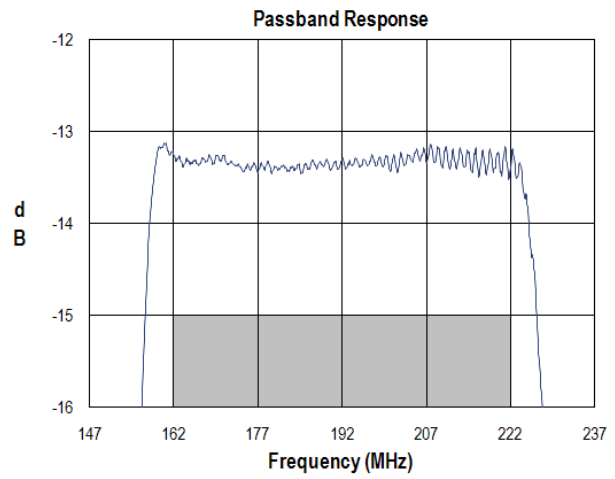
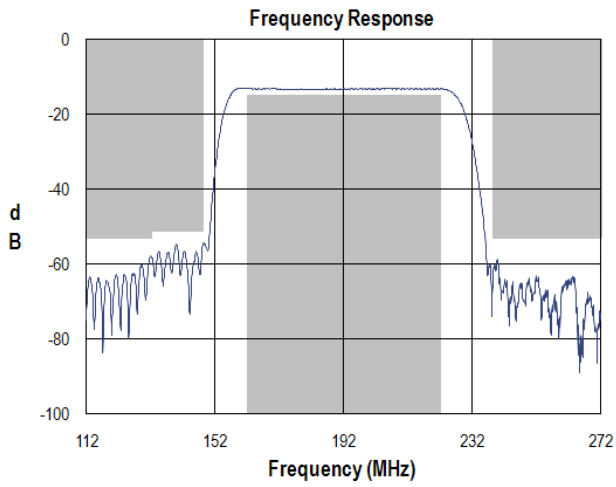

Input Smith Chart

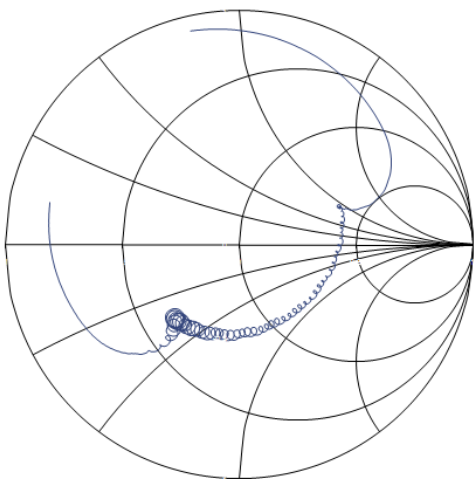

Output Smith Chart

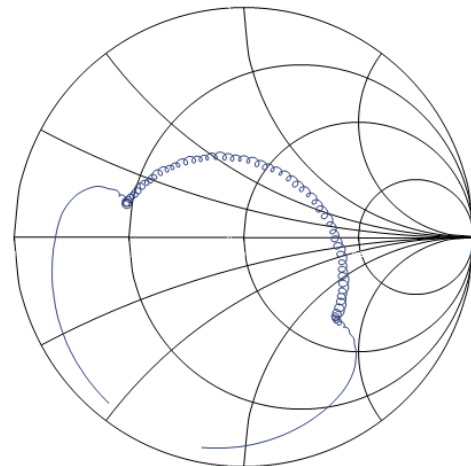

Reference Design – 50Ω SE Input, 150Ω BAL Output

Schematic

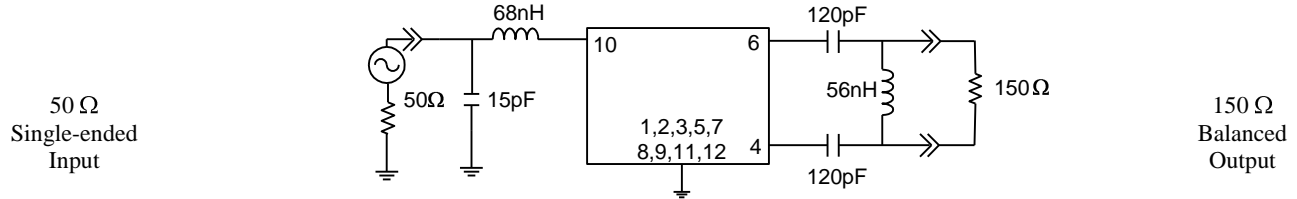

Notes:

- Actual matching values may vary due to PCB layout and parasitic

PC Board

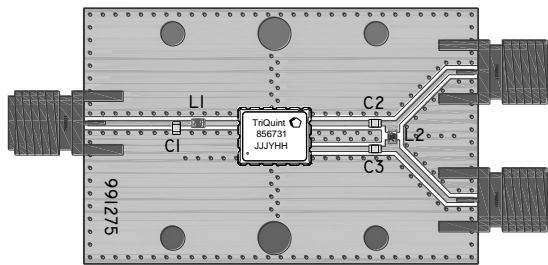

Notes:

- Top, middle & bottom layers: 1 oz copper
- Substrates: FR4 dielectric, .031" thick
- Finish plating: Nickel: 3-8μm thick, Gold: .03-.2μm thick
- Hole plating: Copper min .0008μm thick

Mounting Configuration

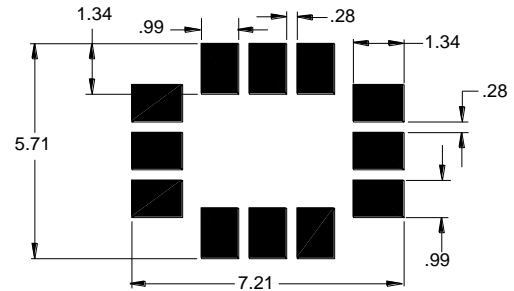

Notes:

- All dimensions are in millimeters.
- This footprint represents a recommendation only.

Bill of Material

Reference Desg.	Value	Description	Manufacturer	Part Number
L1	68nH	Coil Wire-wound, 0603, 5%	MuRata	LQW18AN68NJ00
L2	56nH	Coil Wire-wound, 0603, 5%	MuRata	LQW18AN56NJ00
C1	15pF	Chip Ceramic, 0603, 5%	MuRata	GRM1885C1H150JA01
C2	120pF	Chip Ceramic, 0603, 5%	MuRata	GRM1885C1H121JA01
C3	120pF	Chip Ceramic, 0603, 5%	MuRata	GRM1885C1H121JA01
SMA	N/A	SMA connector	Radiall USA Inc.	9602-1111-018
PCB	N/A	3-layer	multiple	991275

Typical Performance SE/BAL (at room temperature)

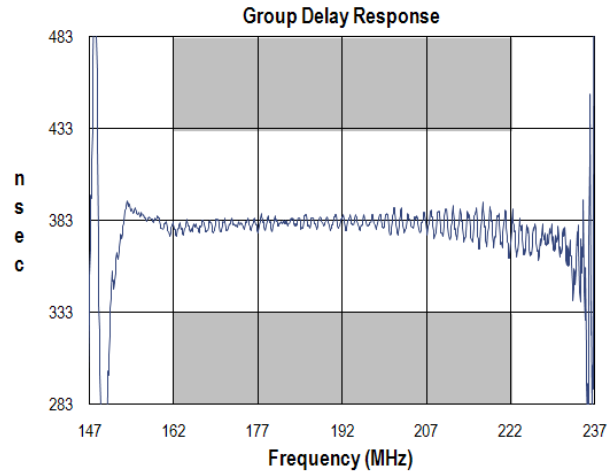
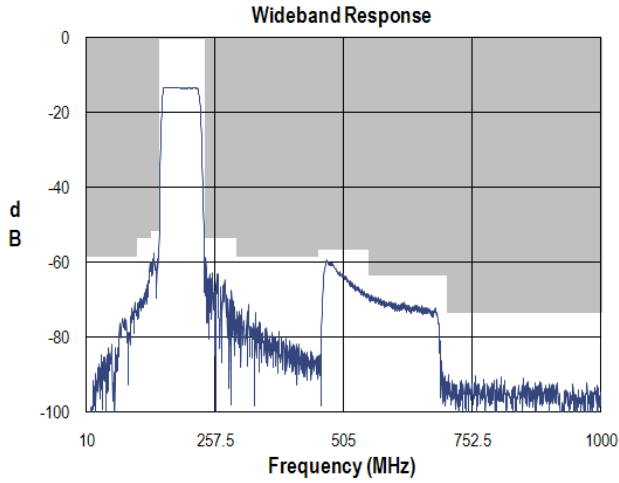
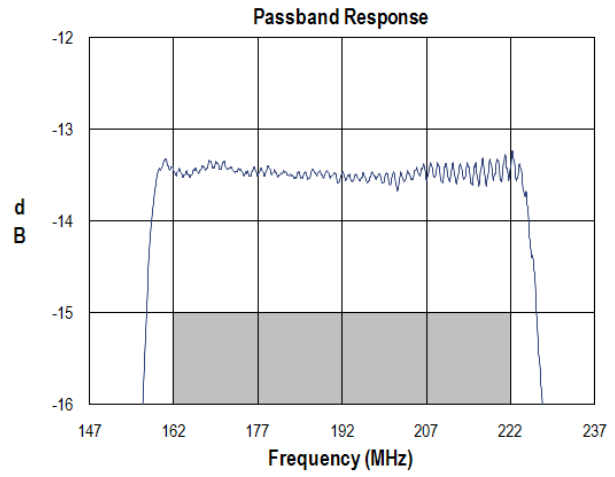
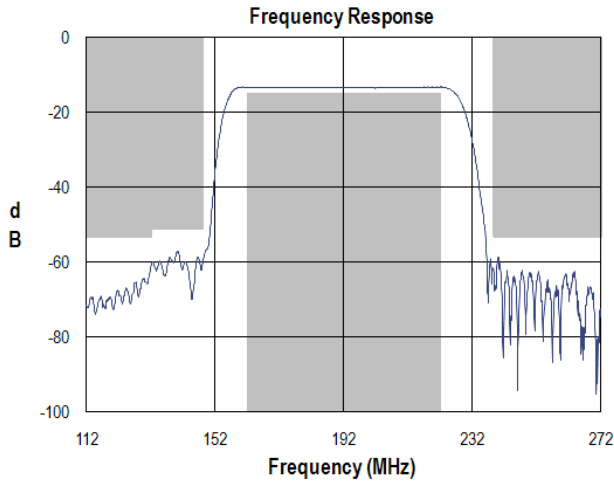

Input Smith Chart

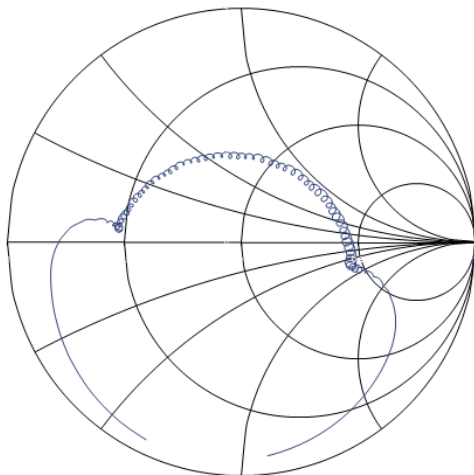

Output Smith Chart

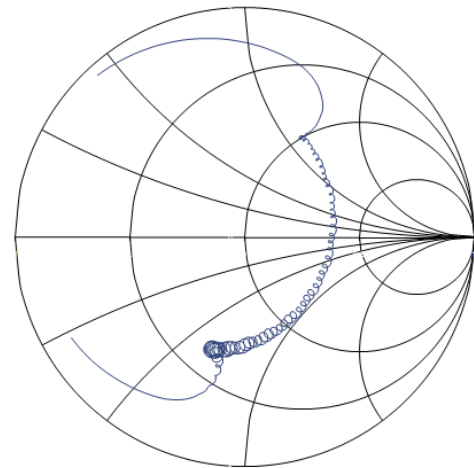

Product Compliance Information

ESD Information



Caution! ESD-Sensitive Device

ESD Rating: 1A

Value: Passes ≥ 400 V min.
Test: Human Body Model (HBM)
Standard: JEDEC Standard JESD22-A114

ESD Rating: B

Value: Passes ≥ 250 V min.
Test: Machine Model (MM)
Standard: JEDEC Standard JESD22-A115

MSL Rating

Devices are Hermetic, therefore MSL is not applicable

Solderability

Compatible with the latest version of J-STD-020, lead free solder, 260°C

Refer to **Soldering Profile** for recommended guidelines.

This part is compliant with EU 2002/95/EC RoHS directive (Restrictions on the Use of Certain Hazardous Substances in Electrical and Electronic Equipment).

This product also has the following attributes:

- Halogen Free (Chlorine, Bromine)
- Antimony Free
- TBBP-A (C₁₅H₁₂Br₄O₂) Free
- PFOS Free
- SVHC Free

Contact Information

For the latest specifications, additional product information, worldwide sales and distribution locations, and information about TriQuint:

Web: www.triquint.com **Tel:** +1.407.886.8860
Email: info-sales@tqs.com **Fax:** +1.407.886.7061

For technical questions and application information:

Email: flapplication.engineering@tqs.com

Important Notice

The information contained herein is believed to be reliable. TriQuint makes no warranties regarding the information contained herein. TriQuint assumes no responsibility or liability whatsoever for any of the information contained herein. TriQuint assumes no responsibility or liability whatsoever for the use of the information contained herein. The information contained herein is provided "AS IS, WHERE IS" and with all faults, and the entire risk associated with such information is entirely with the user. All information contained herein is subject to change without notice. Customers should obtain and verify the latest relevant information before placing orders for TriQuint products. The information contained herein or any use of such information does not grant, explicitly or implicitly, to any party any patent rights, licenses, or any other intellectual property rights, whether with regard to such information itself or anything described by such information.

TriQuint products are not warranted or authorized for use as critical components in medical, life-saving, or life-sustaining applications, or other applications where a failure would reasonably be expected to cause severe personal injury or death.