

RE17RLJU

Harmony, Modular timing relay, 8 A, 1 CO, 0,1 s..100 h, asymmetrical flashing, 12 V AC/DC

Product availability : Non-Stock - Not normally stocked in distribution facility



Price* : 53.00 USD



Main

Range of Product	Harmony Timer Relays
Product or Component Type	Dual function relay
Discrete output type	Relay
Maximum Width	0.69 in (17.5 mm)
Device short name	RE17R
Time delay type	Asymmetrical flashing
Time delay range	6...60 min 1...10 h 6...60 s 1...10 s 10...100 h 0.1...1 s 1...10 min
Nominal output current	8 A

Complementary

Contacts type and composition	1 C/O
Contacts material	Cadmium free
Maximum Height	3.54 in (90 mm)
Maximum Depth	2.83 in (72 mm)
Control type	Selector switch front panel
[Us] rated supply voltage	12 V AC/DC 50/60 Hz
Voltage range	0.9...1.2 Us
Supply frequency	50...60 Hz +/- 5 %
Release of input voltage	5 V
Connections - terminals	Screw terminals, 1 x 0.5...1 x 3.3 mm ² AWG 20...AWG 12) solid without cable end Screw terminals, 2 x 0.5...2 x 2.5 mm ² AWG 20...AWG 14) solid without cable end

* Price is "List Price" and may be subject to a trade discount – check with your local distributor or retailer for actual price.

Screw terminals, 1 x 0.2...1 x 2.5 mm² AWG 24...AWG 14) flexible with cable end
 Screw terminals, 2 x 0.2...2 x 1.5 mm² (AWG 24...AWG 16) flexible with cable end

Tightening torque	5.31...8.85 lbf.in (0.6...1 N.m) IEC 60947-1
Housing material	Self-extinguishing
Repeat accuracy	+/- 0.5 % IEC 61812-1
Temperature Drift	+/- 0.05 %/°C
Voltage drift	+/- 0.2 %/V
Setting accuracy of time delay	+/- 10 % of full scale 25 °C IEC 61812-1
Control signal pulse width	100 ms with load in parallel typical 30 ms typical
Insulation resistance	100 MOhm 500 V DC IEC 60664-1
Reset time	120 ms on de-energisation typical
On-load factor	100 %
Power consumption in VA	0...0.7 VA 12 V AC
Maximum power consumption in W	0.5 W 12 V DC
Minimum switching current	10 mA 5 V DC
Maximum switching current	8 A AC/DC
Maximum switching voltage	250 V AC
Breaking capacity	2000 VA
Operating frequency	10 Hz
Electrical durability	100000 cycles resistive 8 A 250 V AC
Mechanical durability	10000000 cycles
Dielectric strength	2.5 kV 1 mA/1 minute 50 Hz IEC 61812-1
[Uimp] rated impulse withstand voltage	5 kV 1.2/50 µs
Power on delay	100 ms
Marking	CE
Creepage distance	4 kV/3 IEC 60664-1
Safety reliability data	B10d = 270000 MTTFd = 296.8 years
Mounting position	Any position in relation to normal vertical mounting plane
Mounting support	35 mm DIN rail conforming to EN/IEC 60715
Local signalling	LED indicator on steady: relay energised, no timing in progress LED indicator 80 % ON and 20 % OFF flashing: timing in progress
Net Weight	0.15 lb(US) (0.07 kg)
Time delay type	L, Li
Functionality	Asymmetrical flashing timer
Compatibility code	RE17

Environment

Immunity to microbreaks	20 ms
Standards	2006/95/EC 2004/108/EC EN 61000-6-4 IEC 61812-1 EN 61000-6-3 EN 61000-6-2 EN 61000-6-1
Product Certifications	CSA CULus GL
Ambient Air Temperature for Storage	-22...140 °F (-30...60 °C)
Ambient Air Temperature for Operation	-4...140 °F (-20...60 °C)
IP degree of protection	IP20 IEC 60529 terminal block) IP40 IEC 60529 housing) IP50 IEC 60529 front panel)
Vibration resistance	20 m/s ² 10...150 Hz)IEC 60068-2-6

Shock resistance	15 gn 11 ms IEC 60068-2-27
Relative Humidity	93 % without condensation IEC 60068-2-30
Electromagnetic compatibility	Electrostatic discharge immunity test 6 kV in contact) level 3 IEC 61000-4-2 Electrostatic discharge immunity test 8 kV in air) level 3 IEC 61000-4-2 Susceptibility to electromagnetic fields 10 V/m 80 MHz to 1 GHz) level 3 IEC 61000-4-3 Electrical fast transient/burst immunity test 1 kV capacitive connecting clip) level 3 IEC 61000-4-4 Electrical fast transient/burst immunity test 2 kV direct) level 3 IEC 61000-4-4 1.2/50 µs shock waves immunity test 1 kV differential mode) level 3 IEC 61000-4-5 1.2/50 µs shock waves immunity test 2 kV common mode) level 3 IEC 61000-4-5 Conducted RF disturbances 10 V 0.15...80 MHz) level 3 IEC 61000-4-6 Voltage dips and interruptions immunity test 0 % 1 cycle) IEC 61000-4-11 Voltage dips and interruptions immunity test 70 % 25/30 cycles) IEC 61000-4-11 Conducted and radiated emissions class B EN 55022

Ordering and shipping details

Category	22370 - RE, RM MISC TIMERS & COUNTERS
Discount Schedule	CP2
GTIN	03606480552717
Nbr. of units in pkg.	1
Package weight(Lbs)	2.68 oz (76 g)
Returnability	No
Country of origin	ID

Packing Units

Unit Type of Package 1	PCE
Package 1 Height	1.06 in (2.7 cm)
Package 1 width	3.07 in (7.8 cm)
Package 1 Length	3.78 in (9.6 cm)
Unit Type of Package 2	S02
Number of Units in Package 2	40
Package 2 Weight	7.74 lb(US) (3.509 kg)
Package 2 Height	5.91 in (15 cm)
Package 2 width	11.81 in (30 cm)
Package 2 Length	15.75 in (40 cm)

Offer Sustainability

Sustainable offer status	Green Premium product
California proposition 65	WARNING: This product can expose you to chemicals including: Lead and lead compounds, which is known to the State of California to cause cancer and birth defects or other reproductive harm. For more information go to www.P65Warnings.ca.gov
REACH Regulation	REACH Declaration
EU RoHS Directive	Pro-active compliance (Product out of EU RoHS legal scope) EU RoHS Declaration
Mercury free	Yes
RoHS exemption information	Yes
China RoHS Regulation	China RoHS declaration
Environmental Disclosure	Product Environmental Profile
Circularity Profile	End of Life Information

Width 17.5 mm

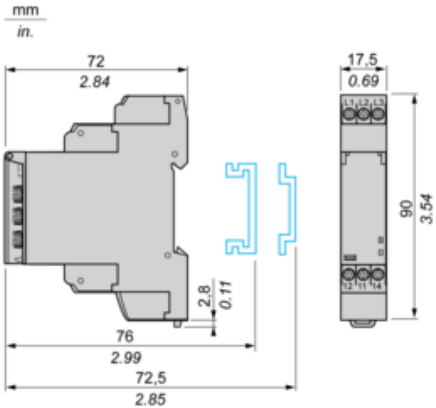

Internal Wiring Diagram

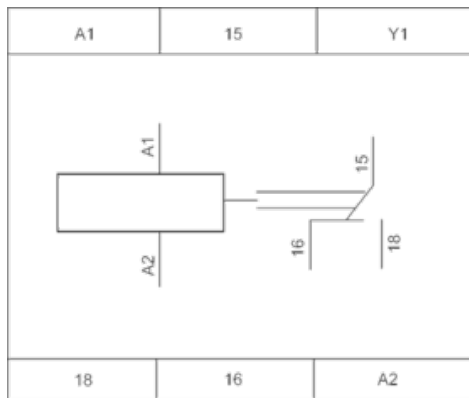

Wiring Diagram

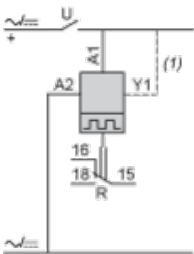

1 Link A1-Y1 for function L only

Function L : Asymmetrical Flasher Relay (Starting Pulse Off)

Description

Repetitive cycle comprises of two, independently adjustable timing periods T_a and T_r . Each timing period corresponds to a different state of the output R.

Function: 1 Output



Function Li : Asymmetrical Flasher Relay (Starting Pulse On)





Description

Repetitive cycle comprises of two, independently adjustable timing periods T_a and T_r . Each timing period corresponds to a different state of the output R.

Function: 1 Output



Legend

-  Relay de-energised
-  Relay energised
-  Output open
-  Output closed

C	Control contact
G	Gate
R	Relay or solid state output
R1/R2	2 timed outputs
R2 inst.	The second output is instantaneous if the right position is selected
T	Timing period
Ta -	Adjustable On-delay
Tr -	Adjustable Off-delay
U	Supply