

REV.	MODIFICATION	DATE	DRAW
A	INITIAL RELEASE	2015.05.12	Vincent
B	INCREASE DIMENSION	2015.07.26	Ann
C	ECN-2016003	2016.05.31	Vincent

A

B

C

D

E

F

A

B

C

D

E

F

HALOGEN FREE LEAD FREE

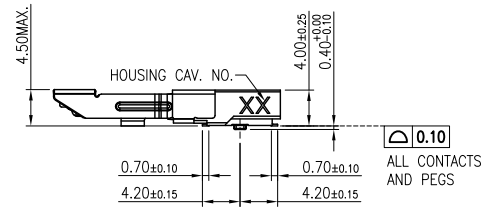
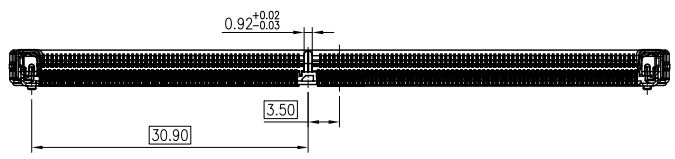
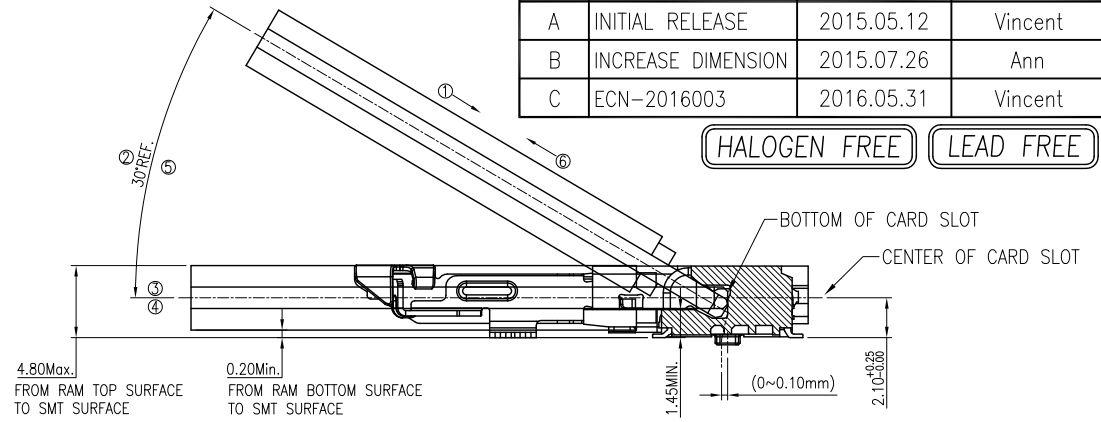
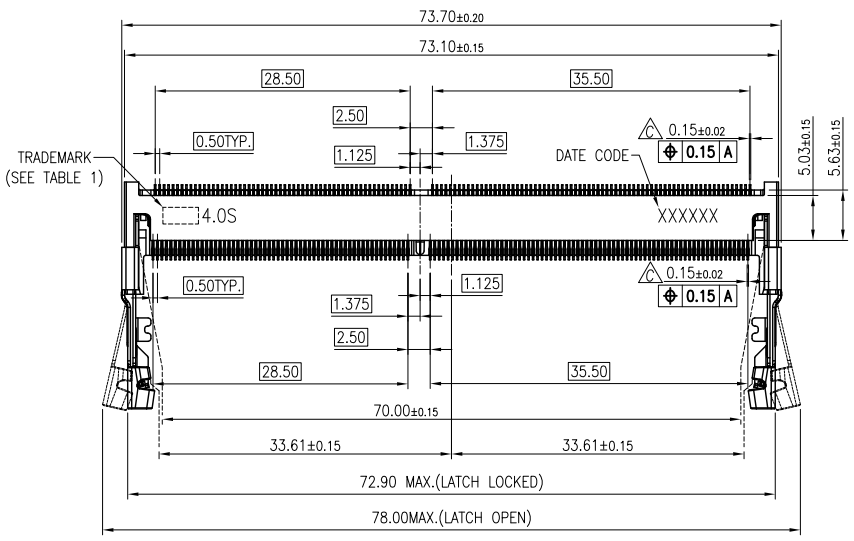

- NOTES
- MATERIAL  
HOUSING: THERMOPLASTIC. UL94V-0.  
CONTACT: HIGH-PERFORMANCE COPPER ALLOY.  
LATCH: STAINLESS STEEL.  
PEG: STAINLESS STEEL.
  - FINISH  
CONTACT: GOLD PLATING(SEE NOTE 4) ON CONTACT AREA AND 1~3u" GOLD PLATING ON SOLDER AREA  
NICKEL(SEE TABLE 1) UNDER PLATING OVER ALL  
PEG: 50~150u" TIN PLATING OVER ALL  
50~150u" NICKEL UNDER PLATING OVER ALL
  - MSL LEVEL:  
MSL(MOISTURE SENSITIVITY LEVEL)=1.
  - PART NO. : D4ASX-260XX-XX40  
SEE TABLE 1  
PLATING CONTACT  
01 : GOLD 1u"Min.  
03 : GOLD 3u"Min.  
05 : GOLD 5u"Min.  
10 : GOLD 10u"Min.  
15 : GOLD 15u"Min.  
20 : GOLD 20u"Min.  
30 : GOLD 30u"Min.  
PACKING  
P: TAPE REEL(NORMAL DIRECTION)  
HOUSING COLOR  
1:BLACK  
2:NATURAL

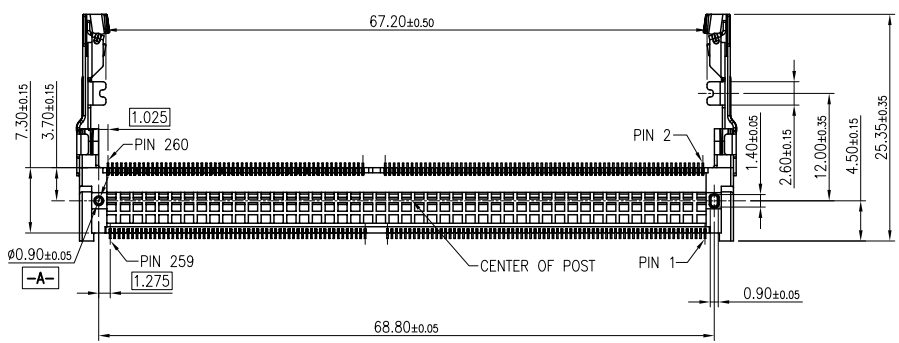

TABLE 1

N	With "LTK"	90~150u"
A	Without "LTK"	50~150u"
O(NUMBER ZERO)	With "LTK"	50~150u"
X	TRADEMARK	CONTACT NICKEL FINISH

DIMENSION IN mm [Inch]	PROD. SPEC.
	SP-D4XXXL1
TOLERANCE UNLESS OTHERWISE SPECIFIED	PKG. SPEC.
	PK-D4XXX-XXX
.X±0.35	X.*± 1*
.XX±0.25	.X.*±
.XXX±	.XX.*±

**LINKTEK**

**深圳市逸沛兴电子科技有限公司**

TITLE: DDR4 4.0H STD CONNECTOR

FILE NO. ARG-220	DWG NO. D4ASX-260XX-XX40
PROJ.	CUSTOMER DRAWING
SIZE A4	SCALE 1:1
SHEET 1/2	REV. C

REV.	MODIFICATION	DATE	DRAW
A	INITIAL RELEASE	2015.05.12	Vincent
B	INCREASE DIMENSION	2015.07.26	Ann
C	ECN-2016003	2016.05.31	Vincent

HALOGEN FREE LEAD FREE

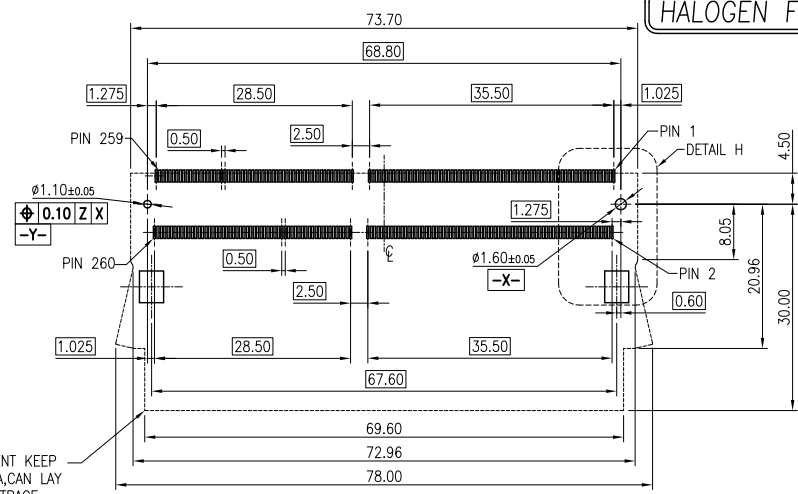
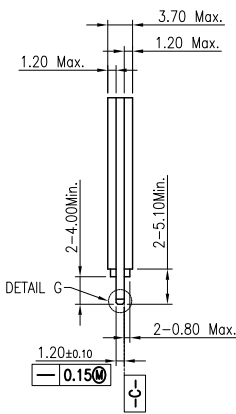
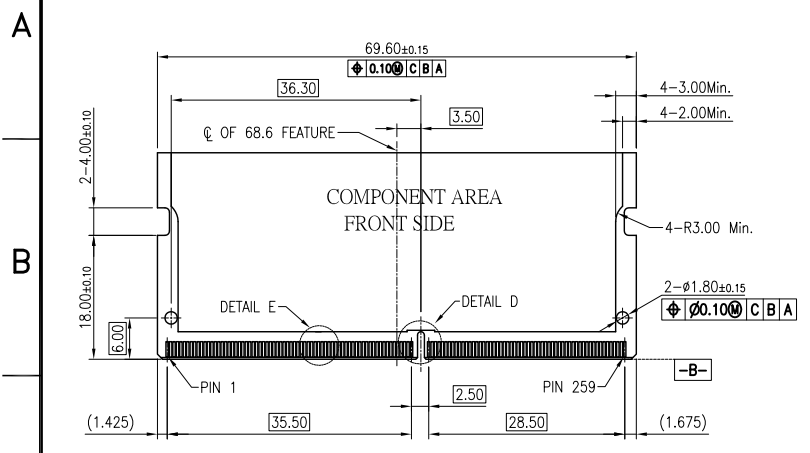

COMPONENT KEEP OUT AREA, CAN LAY VIA AND TRACE

RECOMMEND P.C.B. BOARD LAYOUT  
 PCB THICKNESS 0.80mm Min.  
 PCB LAYOUT GENERIC TOLERANCE: ±0.05  
 (-Z-): PCB SURFACE

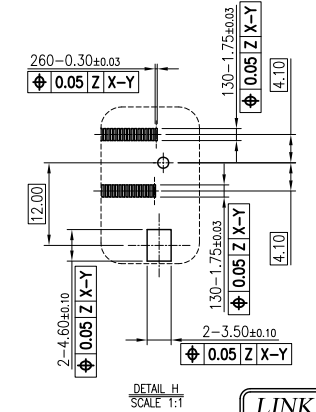
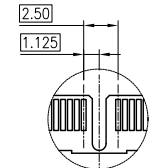
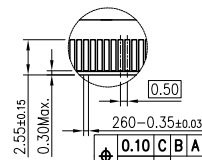
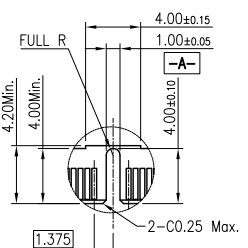
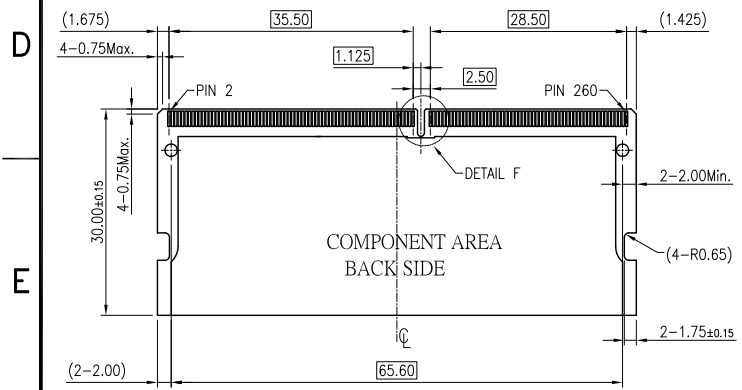

RECOMMEND MODULE CONFIGURATION

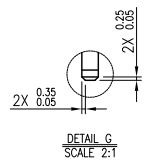

DIMENSION IN mm [Inch]	PROD. SPEC. SP-D4XXXL1
TOLERANCE UNLESS OTHERWISE SPECIFIED	PKG. SPEC. PK-D4XXX-XXX
.X±0.35 X*±1*	APR. Tony 2016.05.31
.XX±0.25 .X*±	CHK. Leon 2016.05.31
.XXX± .XX*±	DRA. Vincent 2016.05.31

深圳市逸沛兴电子科技有限公司

TITLE: DDR4 4.0H STD CONNECTOR

FILE NO. ARG-220	DWG NO. D4ASX-260XX-XX40
PROJ.	CUSTOMER DRAWING
SIZE A4 SCALE 1:1	SHEET 2/2 REV. C C