

2~5PIN无卡点视图

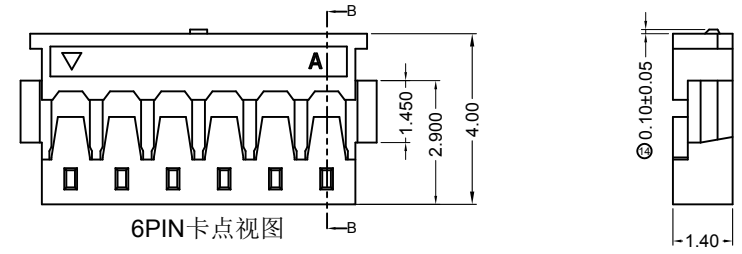

6PIN卡点视图

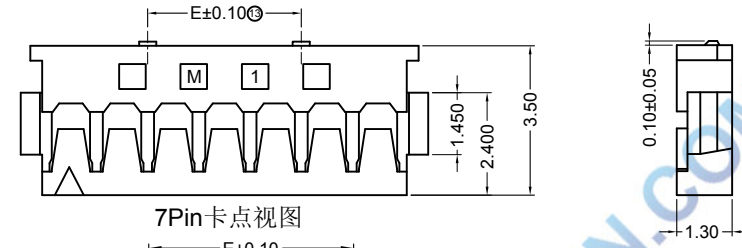

7PIN卡点视图

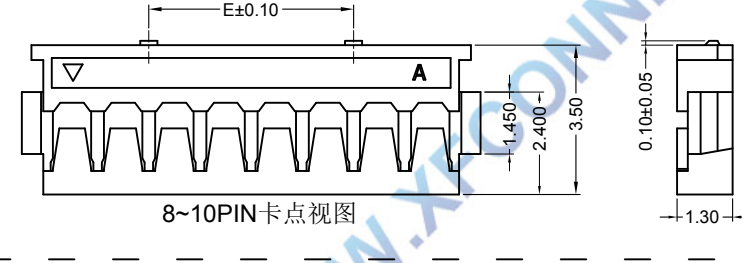

8~10PIN卡点视图

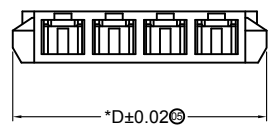

*D±0.02

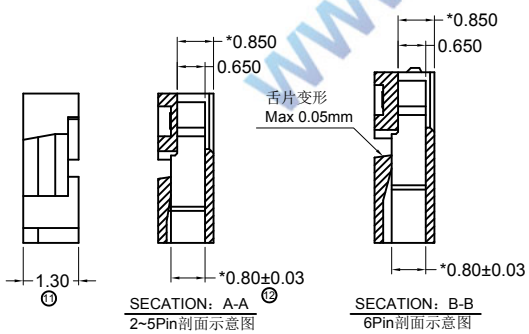
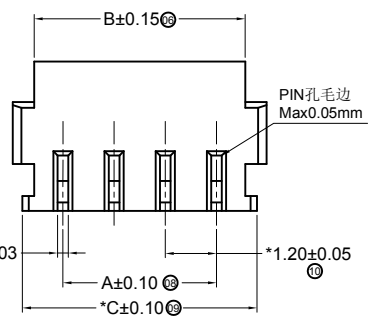

SECTION: A-A
2-5Pin剖面示意图

SECTION: B-B
6Pin剖面示意图

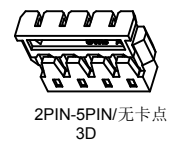

2PIN-5PIN/无卡点
3D

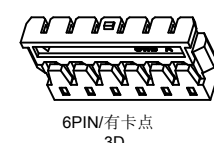

6PIN/有卡点
3D



7-10PIN/有卡点
3D

SPECIFICATIONS

- 1.Voltage rating: 50V AC, DC
- 2.Current rating: 2A, AC, DC
- 3.Withstanding Voltage: 500V AC/minute
- 4.Insulation resistance:100M min
- 5.Temperature range: -25 ° C-+85 ° C
- 6.Contact resistance: 20m max

HOUSING

Housing Material:Nylon66 UL94V-0(2)
 Accepts :T1201 terminal
 Mates with: M1201 series header
 Poles : 02-10P
 Part No.: P1201-xx-BK

Pin位数

| Poles | Dimensions(mm) | | | | |
|-------|----------------|-------|-------|-------|------|
| | A | B | C | D | E |
| 2 | 1.20 | 2.60 | 3.10 | 3.60 | |
| 3 | 2.40 | 3.80 | 4.30 | 4.80 | |
| 4 | 3.60 | 5.00 | 5.50 | 6.00 | |
| 5 | 4.80 | 6.20 | 6.70 | 7.20 | |
| 6 | 6.00 | 7.40 | 7.90 | 8.40 | |
| 7 | 7.20 | 8.60 | 9.10 | 9.60 | 3.60 |
| 8 | 8.40 | 9.80 | 10.30 | 10.80 | 4.80 |
| 9 | 9.60 | 11.00 | 11.50 | 12.00 | 3.60 |
| 10 | 10.80 | 12.20 | 12.70 | 13.20 | 4.80 |

| | | | | | | | | | | | |
|-----------|--------------|------|------|----------------------------|-------|-------|--------|---|--------------|-------------------------------|------|
| | | | | TOLERANCE UNLESS OTHERWISE | | DRAWN | CK tan | XFCN兴飞连接器有限公司 CONNECTORS XFCN CONNECTORS CO., LTD. | | SHEET | 1/1 |
| | | | | X. | ±0.30 | X° | ±5° | | | CHKD | DATE |
| | | | | .X | ±0.20 | .X° | ±2° | APPD | PRODUCT NAME | 1.20mm Crimp Style Connectors | |
| | | | | .XX | ±0.08 | .XX° | ±1° | VIEW | PART. NO. | P1201-xx-BK | |
| | | | | .XXX | ±0.03 | .XXX° | ±0.5° | | | | |
| AO VER | MODIFICATION | DRAW | DATE | | | | | | | | |