

# Shielded Power Inductors – XEL6030

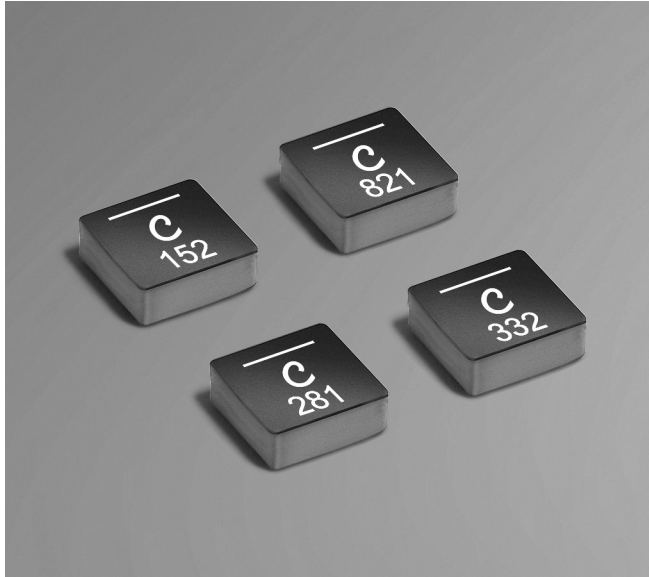

- AEC-Q200 Grade 1 qualified
- Extremely low DCR and ultra low AC losses for high switching frequencies (2 to 5 MHz)
- Superior current handling with soft saturation characteristics; can withstand high current spikes

**Designer's Kit C466** contains 3 of each value

**Core material** Composite

**Environmental** RoHS compliant, halogen free

**Terminations** RoHS compliant tin-silver (96.5/3.5) over copper. Other terminations available at additional cost.

**Weight** 0.62 – 0.66 g

**Ambient temperature** –40°C to +125°C with (40°C rise) Irms current.

**Maximum part temperature** +165°C (ambient + temp rise).

**Storage temperature** Component: –40°C to +165°C.

Tape and reel packaging: –40°C to +80°C

**Resistance to soldering heat** Max three 40 second reflows at +260°C, parts cooled to room temperature between cycles

**Moisture Sensitivity Level (MSL)** 1 (unlimited floor life at <30°C / 85% relative humidity)

**Failures in Time (FIT) / Mean Time Between Failures (MTBF)**

38 per billion hours / 26,315,789 hours, calculated per Telcordia SR-332

**Packaging** 400/7" reel; 1500/13" reel Plastic tape: 16 mm wide, 0.3 mm thick, 12 mm pocket spacing, 3.12 mm pocket depth

**PCB washing** Tested to MIL-STD-202 Method 215 plus an additional aqueous wash. See [Doc787\\_PCB\\_Washing.pdf](#).

Part number <sup>1</sup>	Inductance <sup>2</sup> ±20% (µH)	DCR (mOhms) <sup>3</sup>		SRF typ <sup>4</sup> (MHz)	Isat <sup>5</sup> (A)	Irms (A) <sup>6</sup>	
		typ	max			20°C rise	40°C rise
XEL6030-151ME_	0.15	1.35	1.49	147	45.0	23.6	33.3
XEL6030-281ME_	0.28	2.10	2.35	97	38.0	18.9	26.7
XEL6030-471ME_	0.47	3.01	3.31	63	28.0	15.8	22.3
XEL6030-821ME_	0.82	5.09	5.60	52	21.0	12.1	16.0
XEL6030-102ME_	1.0	6.32	6.95	43	18.0	12.0	16.0
XEL6030-152ME_	1.5	9.57	10.52	34	15.0	10.0	14.0
XEL6030-222ME_	2.2	12.70	13.97	30	13.0	7.0	10.0
XEL6030-332ME_	3.3	19.92	20.81	26	10.5	6.0	8.0

**Irms Testing**

Irms testing was performed on 0.75 inch wide × 0.25 inch thick copper traces in still air.

Temperature rise is highly dependent on many factors including pcb land pattern, trace size, and proximity to other components. Therefore temperature rise should be verified in application conditions.

1. When ordering, please specify **termination** and **packaging** codes:

XEL6030-332MEC

**Termination:** E = RoHS compliant tin-silver (96.5/3.5) over copper.

**Special order:** T = RoHS tin-silver-copper (95.5/4/0.5) or S = non-RoHS tin-lead (63/37).

**Packaging:** C = 7" machine-ready reel. EIA-481 embossed plastic tape (400 parts per full reel).

B = Less than full reel. In tape, but not machine ready. To have a leader and trailer added (\$25 charge), use code letter C instead.

D = 13" machine-ready reel. EIA-481 embossed plastic tape. Factory order only, not stocked (1500 parts per full reel).

2. Inductance tested at 1 MHz, 0.1 Vrms, 0 Adc.

3. DCR measured on a micro-ohmmeter.

4. SRF measured using Agilent/HP 4395A or equivalent.

5. DC current at 25°C that causes an inductance drop of 30% (typ) from its value without current.

[Click for temperature derating information.](#)

6. Current that causes the specified temperature rise from 25°C ambient. This information is for reference only and does not represent absolute maximum ratings. [Click for temperature derating information.](#)

7. Electrical specifications at 25°C.

Refer to Doc 362 "Soldering Surface Mount Components" before soldering.



# Shielded Power Inductors – XEL6030

## L vs Current

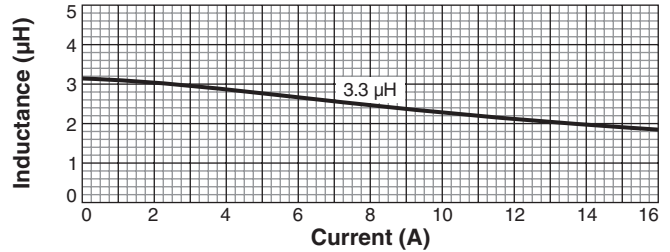
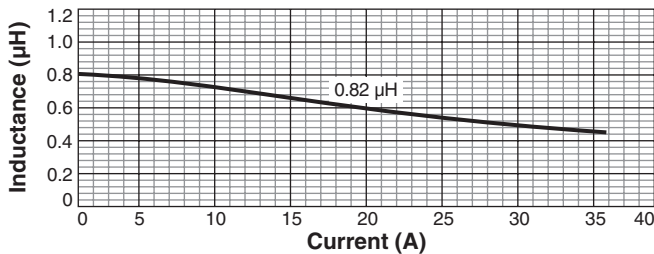
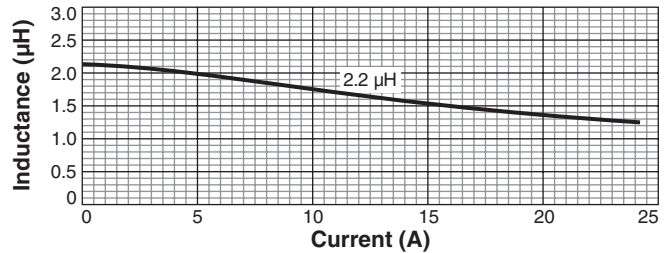
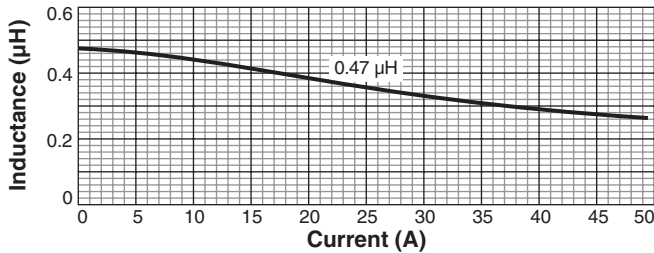
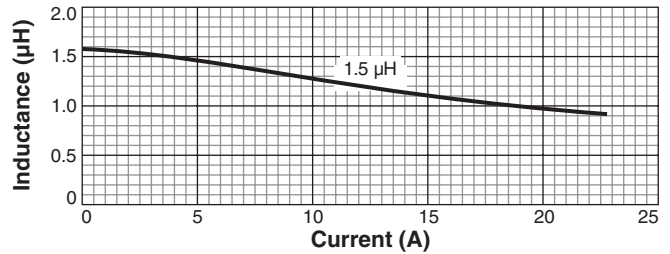
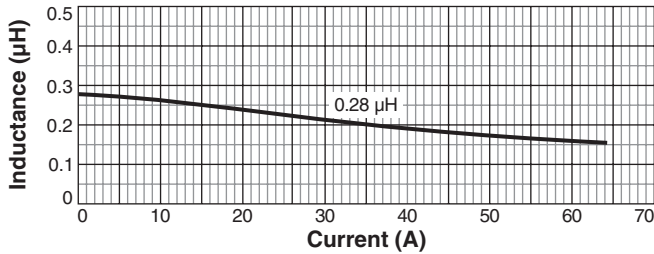
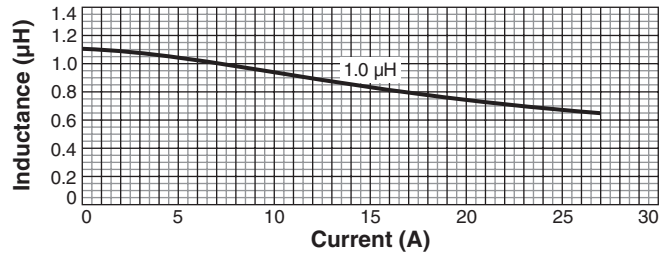
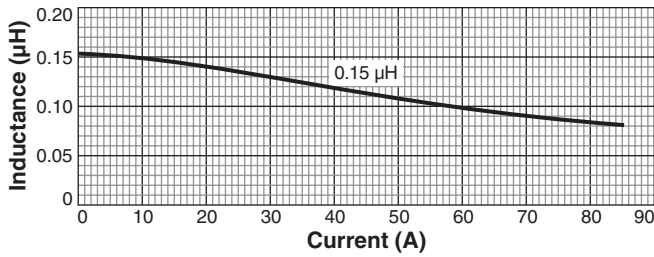

**US** +1-847-639-6400 sales@coilcraft.com  
**UK** +44-1236-730595 sales@coilcraft-europe.com  
**Taiwan** +886-2-2264 3646 sales@coilcraft.com.tw  
**China** +86-21-6218 8074 sales@coilcraft.com.cn  
**Singapore** + 65-6484 8412 sales@coilcraft.com.sg

Document 1353-2 Revised 01/13/18  
 © Coilcraft Inc. 2018  
 This product may not be used in medical or high risk applications without prior Coilcraft approval. Specification subject to change without notice. Please check web site for latest information.



# Shielded Power Inductors – XEL6030

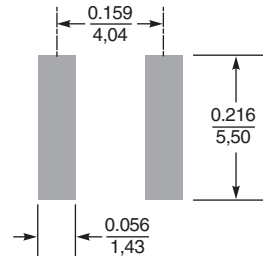
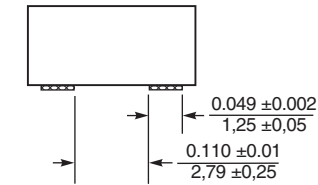
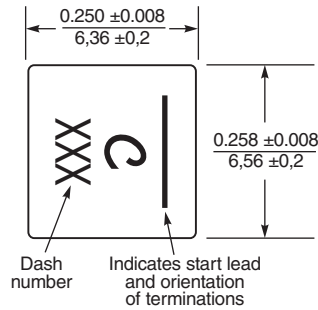

**Recommended Land Pattern**

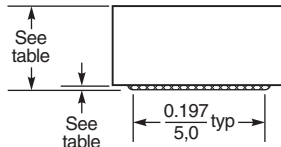

Dash number	Terminal thickness typ (in / mm)	Height max (in / mm)
-151	0.0138 / 0.35	0.126 / 3.2
-281	0.0138 / 0.35	0.126 / 3.2
-471	0.0118 / 0.30	0.126 / 3.2
-821	0.0079 / 0.20	0.126 / 3.2
-102	0.0071 / 0.18	0.122 / 3.1
-152	0.0059 / 0.15	0.122 / 3.1
-222	0.0047 / 0.12	0.122 / 3.1
-332	0.0039 / 0.10	0.122 / 3.1

Dimensions are in  $\frac{\text{inches}}{\text{mm}}$

## L vs Frequency

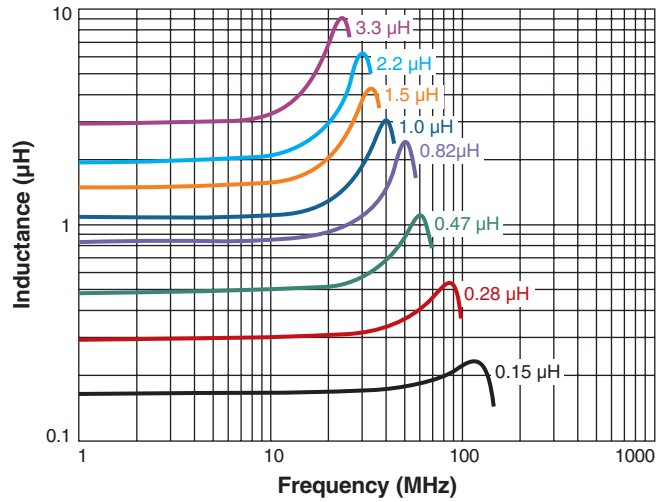

**US** +1-847-639-6400 sales@coilcraft.com  
**UK** +44-1236-730595 sales@coilcraft-europe.com  
**Taiwan** +886-2-2264 3646 sales@coilcraft.com.tw  
**China** +86-21-6218 8074 sales@coilcraft.com.cn  
**Singapore** + 65-6484 8412 sales@coilcraft.com.sg

Document 1353-3 Revised 01/13/18  
 © Coilcraft Inc. 2018  
 This product may not be used in medical or high risk applications without prior Coilcraft approval. Specification subject to change without notice. Please check web site for latest information.