



ELECTRONICS, INC.
 44 FARRAND STREET
 BLOOMFIELD, NJ 07003
 (973) 748-5089
<http://www.nteinc.com>



NTE7208 Integrated Circuit Constant Current Single Output LED Driver

Description:

The NTE7208 is a step-down constant current source designed for driving high power white LEDs. A standard output current of 350mA makes this driver compatible with a wide range of LEDs from many different manufacturers without the need for any external components. Despite its compact size, the NTE7208 is fully featured with very high efficiency, wide input voltage range, high ambient operating temperature and two means of LED dimming: PWM/digital control and analog voltage dimming. Both dimming controls are independent and can be combined. The driver is also designed to be as reliable as the LEDs it is driving, even at the full operating temperature of +85°C.

Features:

- Constant Current Output
- Power LED Driver
- Wide Input Voltage Range
- PWM/Digital Dimming and Analog Voltage Dimming
- Short Circuit Protected
- 96% Efficiency

Electrical Specifications: (Typical at $T_A = +25^\circ\text{C}$, nominal input voltage, rated output current unless otherwise specified.)

Input Voltage (Absolute Maximum)	36V
Recommended Input Voltage	
Minimum	5V
Typical	24V
Maximum	36V
Input Filter	Capacitor
Output Voltage Range ($V_{in} = 36\text{V}$)	2V to 32V
Output Current Range ($V_{in} - V_{out} > 1.5\text{V to } 4\text{V}$)	350mA
Typical Output Current Accuracy ($I_O = 350\text{mA}$)	$\pm 2\%$
Internal Power Dissipation, (Load of 5 LEDs)	700mW
Maximum Output Current Stability ($V_{in} = 36\text{V}, V_{out} = 2\text{V to } 32\text{V}$)	$\pm 1\%$
Maximum Output Ripple and Noise, (20MHz limited, $V_{in} = 36\text{V}, V_{out} = 2\text{V to } 32\text{V}$)	120mV _{p-p}
Maximum Temperature Coefficient ($T_A = -40^\circ$ to $+85^\circ\text{C}$)	$\pm 0.015\%/^\circ\text{C}$
Maximum Capacitive Load,	100 μF
Operating Frequency	
Minimum	210kHz
Typical	260kHz
Maximum	300kHz
Maximum Efficiency at Full Load	96%
Short Circuit Protection	Regulated at Rated Output Current
Operating Temperature Range, T_A	-40° to $+85^\circ\text{C}$
Storage Temperature Range, T_{stg}	-55° to $+125^\circ\text{C}$

Electrical Specifications (Cont'd): (Typical at $T_A = +25^\circ\text{C}$, nominal input voltage, rated output current unless otherwise specified.)

Maximum Case Temperature, T_C	+100°C
Thermal Impedance (Nature Convection)	+55°C/W
Case Material	Non Conductive Black Plastic
Potting Material	Epoxy (UL94-V0)
Maximum Wave Soldering Profile (10 seconds)	+235°C

PWM Dimming and ON/OFF Control (Leave Open if Not Used):

Remote ON/OFF

DC/DC ON,	Open or $0\text{V} < V_r < 0.6\text{V}$
DC/DC OFF (Standby)	$0.6 < V_r < 2.9\text{V}$
DC/DC OFF (Shutdown),	$2.9 < V_r < 6\text{V}$

Maximum Remote Pin Drive Current ($V_r = 5\text{V}$)

Maximum Quiescent Input Current in Shutdown Mode ($V_{in} = 36\text{V}$, $V_r > 2.9\text{V}$)

Maximum PWM Frequency for Linear Operation (measured 10% to 90% Dimming)

Analog Dimming Control (Leave Open if Not Used):

Input Voltage Range

Control Voltage Range Limits

Full On	$0.13\text{V} \pm 50\text{mV}$
Full Off	$4.5\text{V} \pm 50\text{mV}$

Maximum Analog Pin Drive Current ($V_c = 5\text{V}$)

Environmental:

Relative Humidity (See Note)

Conducted Emissions

Radiated Emissions

ESD

Radiated Immunity

Fast Transient

Conducted Immunity

MTBF (RCD-24-0.70, Nominal V_{in} , Full Load)

+25°C

Using MIL-HDBK 217F, +71°C

Note: Requires an input filter to meet EN55022 Class B conducted emissions, see below.

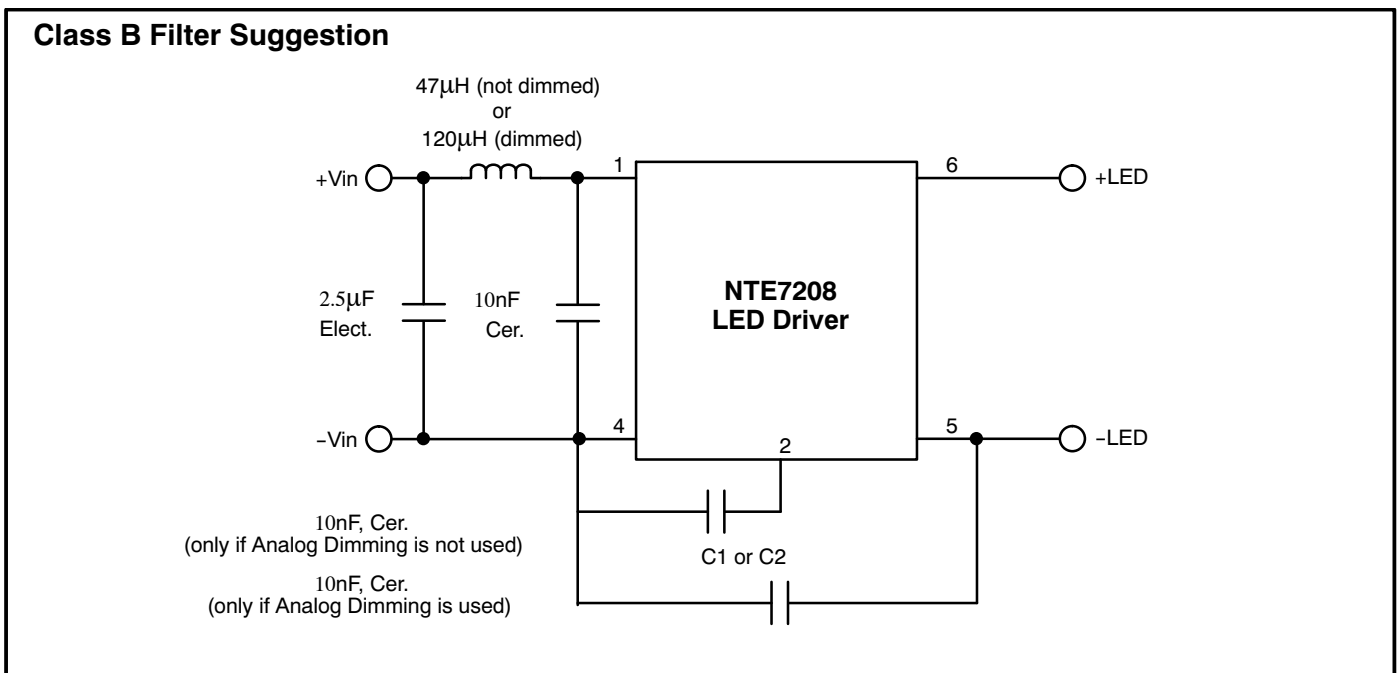

Analog Dimming Control and Application Circuit Examples

LED Driver with 0-10V Interface

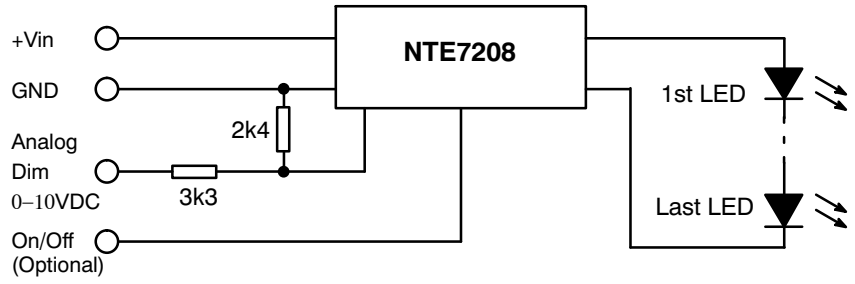

LED DIMMER for up to 7 white LEDs

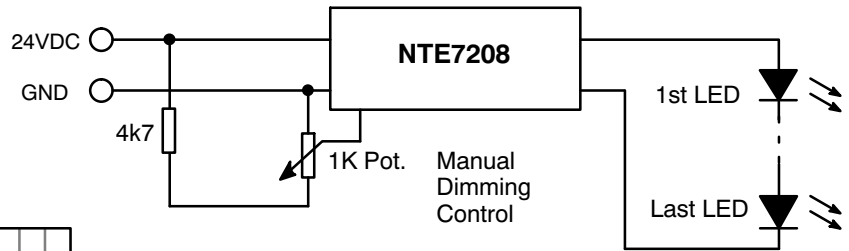

Voltage Control (0-15V max)

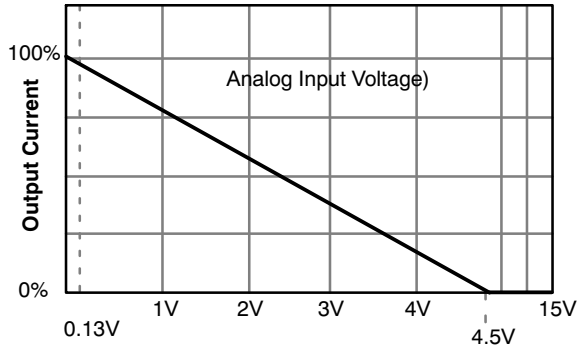

Digital Dimming Control

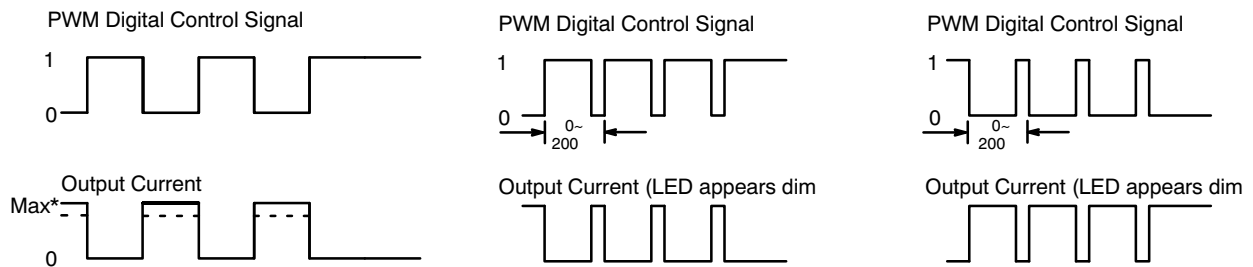

*Max output current can also be set using Analog input

Package Style and Pinning

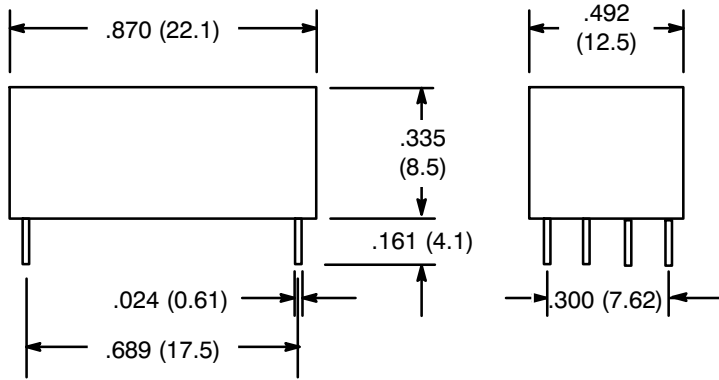

Pin Connections

Pin #	Out	Comments
1	+Vin	DC Supply
2	Analog Dimming	Leave open if not used
3	PWM/ON/OFF	Leave open if not used
4	GND	Do not connect to -Vout
5	-Vout	LED Cathode Connection
6	+Vout	LED Anode Connection

xx.x ±0.5mm
 xx.xx ±0.25mm
 Pin Tolerance
 0.1mm

Recommended Footprint Details

Leave 1mm space around case pcb

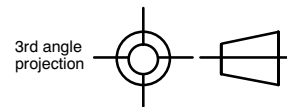
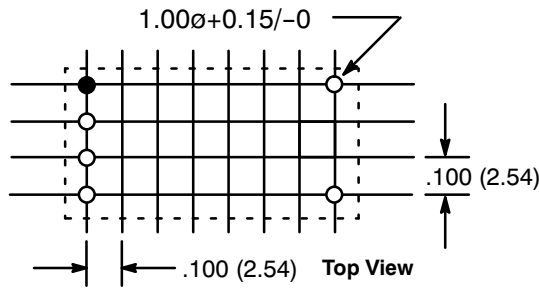
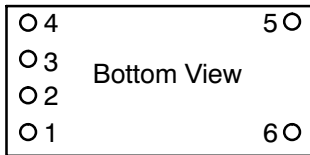

Analog Dimming Control and Application Circuit Examples

LED Driver

