

3M™ Pak 20 Wiremount Socket

2 mm × 2 mm for 1 mm Pitch Cable

1522 Series

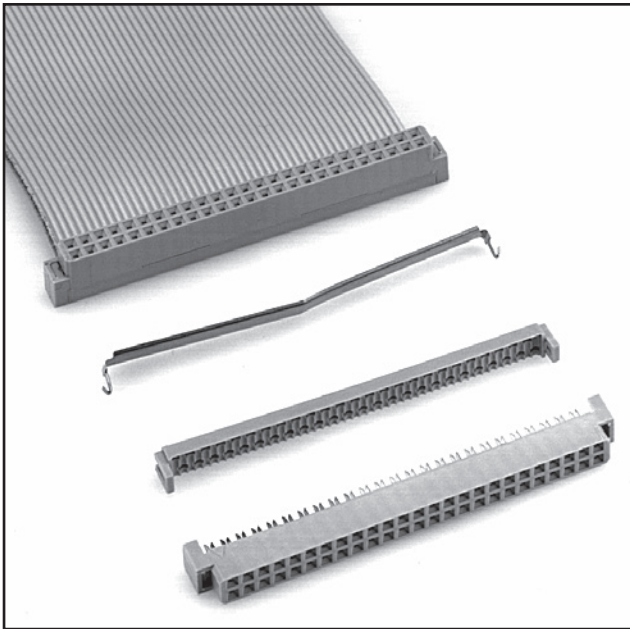

- Industry standard compatible
- Mates with Pak 20 (2 mm x 2 mm) grid pin strips
- Low profile
- Preassembled covers
- Available with or without strain relief
- Available with optional centerbump polarity feature
- See the Regulatory Information Appendix (RIA) in the “RoHS compliance” section of www.3mconnector.com for compliance information (RIA E1 & C1 apply)

Date Modified: April 15, 2010

TS-0523-C
Sheet 1 of 3

Physical

Insulation:

Material: Glass Filled Polyester (PBT)

Flammability: UL 94V-0

Color: Gray

Contact:

Material: Copper Alloy

Plating:

Underplating and U-Slot: 50 -150 μ” [1.27-3.81 μm] Nickel - QQ-N-290, Class 2

Wiping Area: Gold, MIL-G-45204, Type II, Grade C

Wire Accommodation: 28 AWG Stranded

Marking: 3M Logo, Part Identification Number and Orientation Triangle

Note: The location and thickness of the contact plating is determined by the part number. Refer to ordering information.

Electrical

Current Rating: 1A

Insulation Resistance: $> 1 \times 10^9 \Omega$ at 500 V_{DC}

Withstanding Voltage: 1,000 V_{RMS} at Sea Level

Environmental

Temperature Rating: -55°C to +105°C

UL File No.: E68080

RoHS = Directive 2002/95/EC,
Restriction of the Use of Certain Hazardous Substances in Electrical and Electronic Equipment

3M™ Pak 20 Wiremount Socket

2 mm × 2 mm for 1 mm Pitch Cable

1522 Series

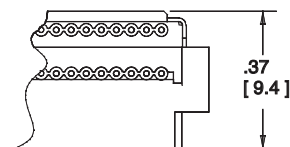
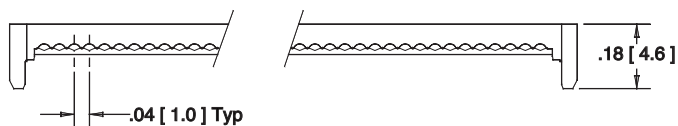
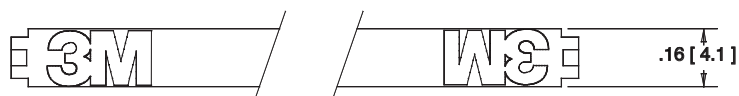

Assembled Height with Strain Relief

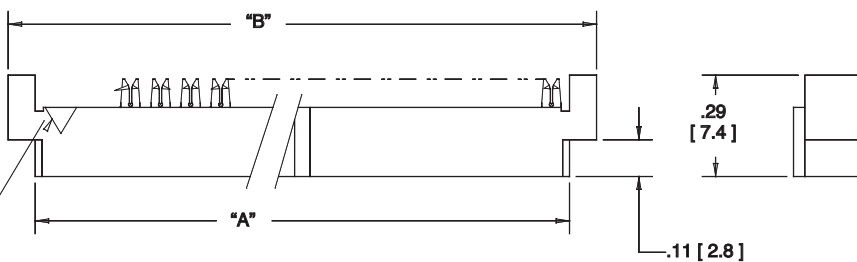

Delta Indicates Position No. 1

Optional Center Bump Polarity Feature

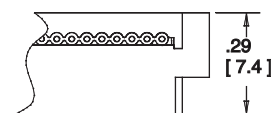
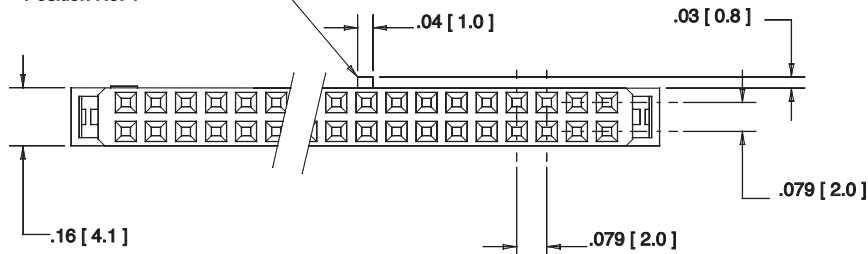

Assembled Height without Strain Relief

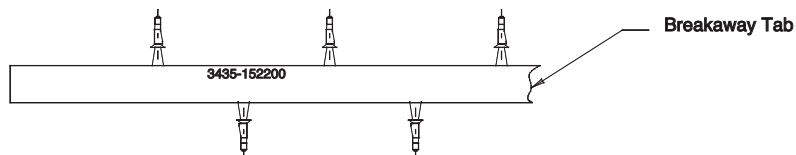

Keying Plug (Optional, Order Separately)

Inch (mm)		
Tolerance Unless Noted		
.0	.00	.000
±.1	±.01	±.005

[] Dimensions for Reference only

Ordering Information

Socket
1522XX - 0XXXXX RIA (E1 & C1 Apply)

Contact Quantity: _____
(See Table 1)

- 0 = Preassembled Closed Cover, on even row side
- 1 = Preassembled Open Cover
- 2 = Preassembled Closed Cover, on odd row side

- 0 = No Polarization
- 1 = Center Bump

Plating
GB = 30 μ" [0.76 μm] Avg Gold
GG = 15 μ" [0.38 μm] Avg Gold

- 0 = No Strain Relief
- 3 = With Strain Relief

Strain Relief
3448-1522XX

Contact Quantity _____
(See Table 1)

Keying Plug
3435-152200
Order Separately

Application Tools: 3640 press (or equivalent), 3443-118 locator plate, 3442-9 platen

TS-0523-C
Sheet 2 of 3

3M™ Pak 20 Wiremount Socket

2 mm × 2 mm for 1 mm Pitch Cable

1522 Series



Table 1		
Contact Quantity	Dimensions	
	A	B
10	.45 [11.4]	.59 [15.0]
12	.53 [13.4]	.67 [17.0]
20	.84 [21.3]	.99 [25.1]
26	1.08 [27.4]	1.22 [31.0]
40	1.63 [41.4]	1.77 [45.0]
44	1.79 [45.5]	1.93 [49.0]
50	2.03 [51.3]	2.17 [55.0]

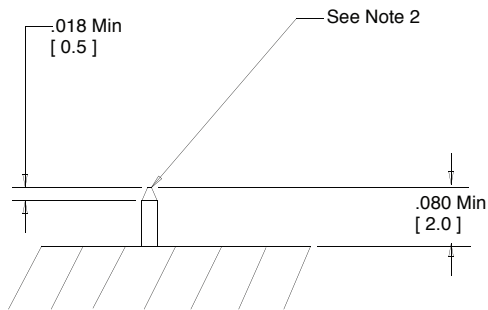

Mating Pin Detail

Inch (mm)			
Tolerance Unless Noted			
	.0	.00	.000
Inch	± .1	± .01	± .005

[] Dimensions for Reference only

TS-0523-C
Sheet 3 of 3

Important Notice

All statements, technical information, and recommendations related to 3M's products are based on information believed to be reliable, but the accuracy or completeness is not guaranteed. Before using this product, you must evaluate it and determine if it is suitable for your intended application. You assume all risks and liability associated with such use. Any statements related to the product which are not contained in 3M's current publications, or any contrary statements contained on your purchase order shall have no force or effect unless expressly agreed upon, in writing, by an authorized officer of 3M.

Warranty; Limited Remedy; Limited Liability.

This product will be free from defects in material and manufacture for a period of one (1) year from the time of purchase. **3M MAKES NO OTHER WARRANTIES INCLUDING, BUT NOT LIMITED TO, ANY IMPLIED WARRANTY OF MERCHANTABILITY OR FITNESS FOR A PARTICULAR PURPOSE.** If this product is defective within the warranty period stated above, your exclusive remedy shall be, at 3M's option, to replace or repair the 3M product or refund the purchase price of the 3M product. **Except where prohibited by law, 3M will not be liable for any indirect, special, incidental or consequential loss or damage arising from this 3M product, regardless of the legal theory asserted.**

**3M Electronics Solutions Division**

6801 River Place Blvd.
Austin, TX 78726-9000
U.S.A.
1-800-225-5373
www.3Mconnector.com

Please recycle. Printed in USA.
© 3M 2010. All rights reserved.
RIA-2217B-E

3M is a trademark of 3M Company.