

3507 AND 3508

RATIOMETRIC, LINEAR HALL-EFFECT SENSORS FOR HIGH-TEMPERATURE OPERATION

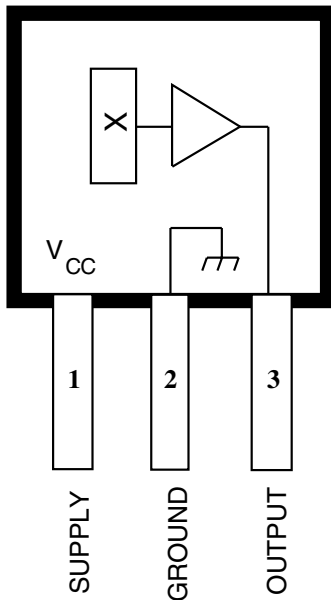

Dwg. PH-006

Pinning is shown viewed from branded side.

ABSOLUTE MAXIMUM RATINGS

Supply Voltage, V_{CC}	6.0 V
Output Voltage, V_O	6.0 V
Output Sink Current, I_O	5.0 mA
Magnetic Flux Density, B	Unlimited
Package Power Dissipation, P_D	See Graph
Operating Temperature Range, T_A	
Suffix 'S-'	-20°C to +85°C
Suffix 'E-'	-40°C to +85°C
Suffix 'L-'	-40°C to +150°C
Storage Temperature Range, T_S	-65°C to +170°C

The A3507- and A3508- are sensitive, temperature-stable linear Hall-effect sensors. Ratiometric, linear Hall-effect sensors provide a voltage output that is proportional to the applied magnetic field and have a quiescent output voltage that is approximately 50% of the supply voltage. These magnetic sensors are ideal for use in linear and rotary position sensing systems in the harsh environments of automotive and industrial applications over extended temperatures to -40°C and +150°C. The two devices are similar except for temperature stability over the operating temperature range. See the Magnetic Characteristics table for complete, individual device parametrics.

Each monolithic circuit integrates a quadratic Hall element, improved temperature compensating circuitry to reduce the intrinsic sensitivity drift of the Hall element, a small-signal high-gain amplifier, and a rail-to-rail low-impedance output stage. Many problems normally associated with low-level analog signals are minimized by having the Hall element and amplifier in a single chip. Output precision is obtained by internal gain and offset trim adjustments during the manufacturing process.

The first character of the part number suffix determines the device operating temperature range: suffix 'S-' is for -20°C to +85°C, suffix 'E-' is for -40°C to +85°C, and suffix 'L-' is for -40°C to +150°C. These devices are supplied in a 3-pin ultra-mini-SIP '-UA' package.

FEATURES

- Output Voltage Proportional to Applied Magnetic Field
- Ratiometric Rail-to-Rail Output
- Improved Sensitivity
- Superior Temperature Stability
- 4.5 V to 5.5 V Operation
- Small Package Size
- Solid-State Reliability

Always order by complete part number, e.g., **[A3507EUA]**.

3507 AND 3508 RATIOMETRIC, LINEAR HALL-EFFECT SENSORS FOR HIGH-TEMP. OPERATION

FUNCTIONAL BLOCK DIAGRAM

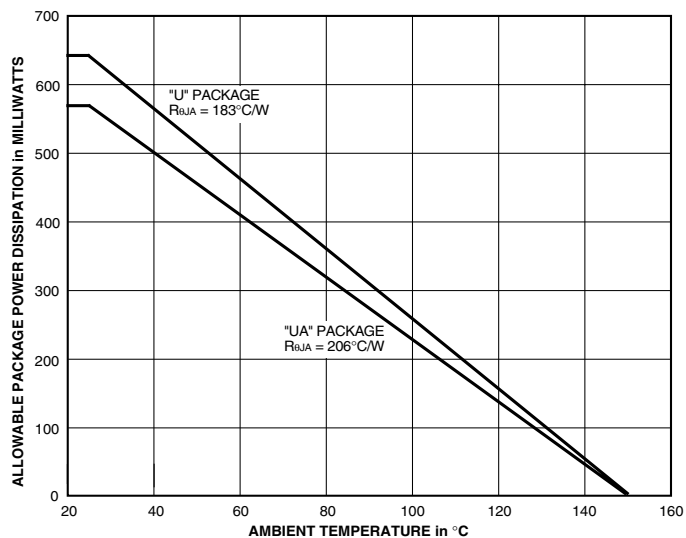
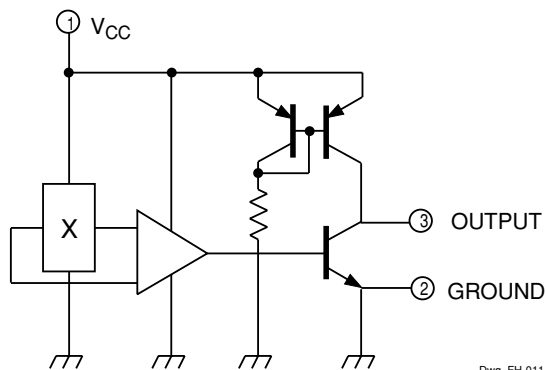

ELECTRICAL CHARACTERISTICS over operating temperature range, at $V_{CC} = 5\text{ V}$ (unless otherwise noted).

Characteristic	Symbol	Test Conditions	Limits			
			Min.	Typ.	Max.	Units
Supply Voltage	V_{CC}	Operating	4.5	5.0	5.5	V
Supply Current	I_{CC}	$B = 0, V_{CC} = 5.5\text{ V}, I_O = 0$	—	—	10	mA
Quiescent Voltage Output	V_{OQ}	$B = 0, I_O = 1\text{ mA}, T_A = 25^\circ\text{C}$	2.0	2.5	3.0	V
		$B = 0, I_O = 1\text{ mA}$	1.8	2.5	3.2	V
Output Voltage	V_{OH}	$B = +X^*, I_O = 1\text{ mA}$	4.5	4.8	—	V
	V_{OL}	$B = -X^*, I_O = -1\text{ mA}$	—	0.2	0.5	V
Bandwidth (-3 dB)	BW		20	—	—	kHz
Output Resistance	r_O		—	2.5	10	Ω
Wide-Band Output Noise	e_o	$B = 0, BW = 10\text{ Hz to }10\text{ kHz}, T_A = 25^\circ\text{C}$	—	125	—	μV

Negative current is defined as coming out of (sourcing) the output.

* This test requires positive and negative fields sufficient to swing the output driver between fully OFF and saturated (ON), respectively. It is NOT intended to indicate a range of linear operation.

3507 AND 3508
RATIOMETRIC,
LINEAR HALL-EFFECT SENSORS
FOR HIGH-TEMP. OPERATION

MAGNETIC CHARACTERISTICS over operating temperature range, at $V_{CC} = 5\text{ V}$, $I_o = 1\text{ mA}$
(unless otherwise noted).

Characteristic*	Part Numbers									Units
	A3507LUA			A3507EUA			A3508SUA			
	Min.	Typ.	Max.	Min.	Typ.	Max.	Min.	Typ.	Max.	
Operating Temp. Range, T_A	-40	–	+150	-40	–	+85	-20	–	+85	°C
Sensitivity at $T_A = 25^\circ\text{C}$	2.0	2.5	3.0	2.0	2.5	3.0	2.0	2.5	3.0	mV/G
over Oper. Temp. Range	1.7	2.5	3.3	1.7	2.5	3.3	1.7	2.5	3.3	mV/G
$\Delta\text{Sens}_{(\Delta T)}^\dagger$ at $T_A = \text{Max.}$	-5.0	2.5	10	-6.3	1.2	8.7	-10	–	10	%
at $T_A = \text{Min.}$	-8.8	-1.3	6.2	-8.8	-1.3	6.2	-10	–	10	%
$\Delta V_{OQ(\Delta T)}^\ddagger$	–	–	± 35	–	–	± 35	–	–	± 50	G
Ratiometry, $\Delta V_{OQ(\Delta V)}$	–	100	–	–	100	–	–	100	–	%
Ratiometry, $\Delta\text{Sens}_{(\Delta V)}$	–	100	–	–	100	–	–	100	–	%
Positive Linearity, Lin+	–	100	–	–	100	–	–	100	–	%
Negative Linearity, Lin–	–	100	–	–	100	–	–	100	–	%
Symmetry	–	100	–	–	100	–	–	100	–	%

Magnetic flux density is measured at most sensitive area of device located 0.018" (0.46 mm) below the branded face of the "UA" package.

* See Characteristics Definitions for test conditions.

† The nominal sensitivity temperature stability is designed to compensate for the temperature coefficient of samarium-cobalt magnets (-0.02%/°C).

‡ This calculation (formula 1, next page) yields the device's equivalent accuracy, over the operating temperature range, in gauss.

3507 AND 3508 RATIOMETRIC, LINEAR HALL-EFFECT SENSORS FOR HIGH-TEMP. OPERATION

CHARACTERISTICS DEFINITIONS

Quiescent Voltage Output. In the quiescent state (no magnetic field), the output is ideally equal to one-half of the supply voltage over the operating voltage and temperature range ($V_{OQ} \cup V_{CC}/2$). Due to internal component tolerances and thermal considerations, there is a tolerance on the quiescent voltage output and on the quiescent voltage output as a function of supply voltage and ambient temperature. For purposes of specification, the quiescent voltage output as a function of temperature is defined as

$$\Delta V_{OQ(\Delta T)} = \frac{V_{OQ(TA)} - V_{OQ(25^{\circ}C)}}{Sens_{(25^{\circ}C)}} \quad (1)$$

This calculation yields the device's equivalent accuracy, over the operating temperature range, in gauss.

Sensitivity. The presence of a south-pole magnetic field perpendicular to the package face (the branded surface) will increase the output voltage from its quiescent value toward the supply voltage rail by an amount proportional to the magnetic field applied. Conversely, the application of a north pole will decrease the output voltage from its quiescent value. This proportionality is specified as the sensitivity of the device and is defined as

$$Sens = \frac{V_{O(500G)} - V_{O(-500G)}}{1000 \text{ G}} \quad (2)$$

The stability of sensitivity as a function of temperature is defined as

$$\Delta Sens_{(\Delta T)} = \frac{Sens_{(TA)} - Sens_{(25^{\circ}C)}}{Sens_{(25^{\circ}C)}} \times 100\% \quad (3)$$

Ratiometry. The A3507– and A3508– feature a ratiometric output. The quiescent voltage output and sensitivity are proportional to the supply voltage (ratiometric).

The per cent ratiometric change in the quiescent voltage output is defined as

$$\Delta V_{OQ(\Delta V)} = \frac{V_{OQ(VCC)} / V_{OQ(5V)}}{V_{CC} / 5 \text{ V}} \times 100\% \quad (4)$$

and the per cent ratiometric change in sensitivity is defined as

$$\Delta Sens_{(\Delta V)} = \frac{Sens_{(VCC)} / Sens_{(5V)}}{V_{CC} / 5 \text{ V}} \times 100\% \quad (5)$$

Linearity and Symmetry. The on-chip output stage is designed to provide a linear output to within 500 mV of either rail with a supply voltage of 5 V. This is equivalent to approximately ± 800 gauss of ambient field. Although application of stronger magnetic fields will not damage these devices, it will force the output into a non-linear region. Linearity in per cent is measured and defined as

$$Lin+ = \frac{V_{O(500G)} - V_{OQ}}{2 (V_{O(250G)} - V_{OQ})} \times 100\% \quad (6)$$

$$Lin- = \frac{V_{O(-500G)} - V_{OQ}}{2 (V_{O(-250G)} - V_{OQ})} \times 100\% \quad (7)$$

and output symmetry as

$$Sym = \frac{V_{O(500G)} - V_{OQ}}{V_{OQ} - V_{O(-500G)}} \times 100\% \quad (8)$$

3507 AND 3508 RATIOMETRIC, LINEAR HALL-EFFECT SENSORS FOR HIGH-TEMP. OPERATION

APPLICATIONS INFORMATION

Calibrated linear Hall devices, which can be used to determine the actual flux density presented to the sensor in a particular application, are available.

For safe, reliable operation, the output should not be pulled above the supply voltage or pulled below the device ground.

For optimum performance, a 100 pF capacitor between the output and ground should be added.

The nominal sensitivity is factory set to compensate for the temperature coefficient of samarium-cobalt magnets ($-0.02\%/^{\circ}\text{C}$).

The ratiometric feature is especially valuable when these devices are used with an analog-to-digital converter. A/D converters typically derive their LSB step size by ratioing off a reference voltage line. If the reference voltage varies, the LSB will vary proportionally. This is a major error source in many sensing systems. The A3507/08– can eliminate this source of error by their ratiometric operation. Because their gain and offsets are proportional to the supply voltage, if they are powered from the A/D reference voltage, the sensor output voltage will track changes in the LSB value.

Hall-effect applications information is available in the application note “Linear Hall-Effect Sensors” (AN 27702), which can be found in the latest issue of *Allegro Electronic Data Book*, AMS-702, or at

www.allegromicro.com

SENSOR LOCATION

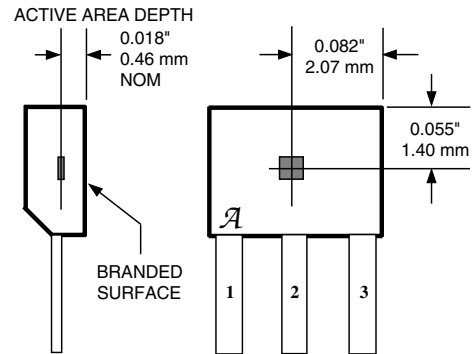

Dwg. MH-011-6A

TYPICAL CURRENT-SENSING APPLICATION

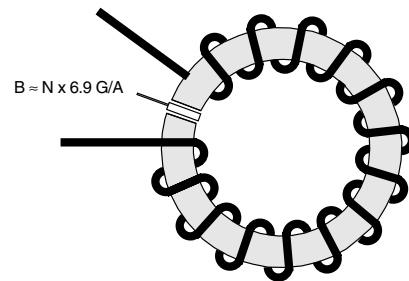

Dwg. AH-005A

3507 AND 3508 RATIOMETRIC, LINEAR HALL-EFFECT SENSORS FOR HIGH-TEMP. OPERATION

TYPICAL POSITION-SENSING APPLICATIONS (Alnico 8, dimensions in inches)

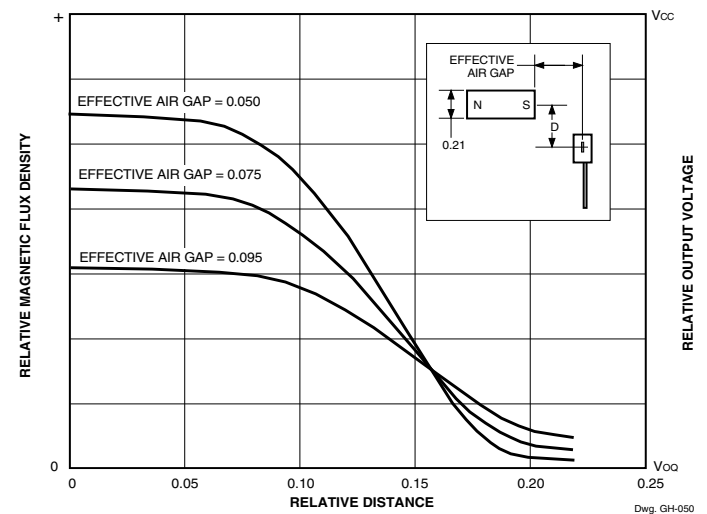
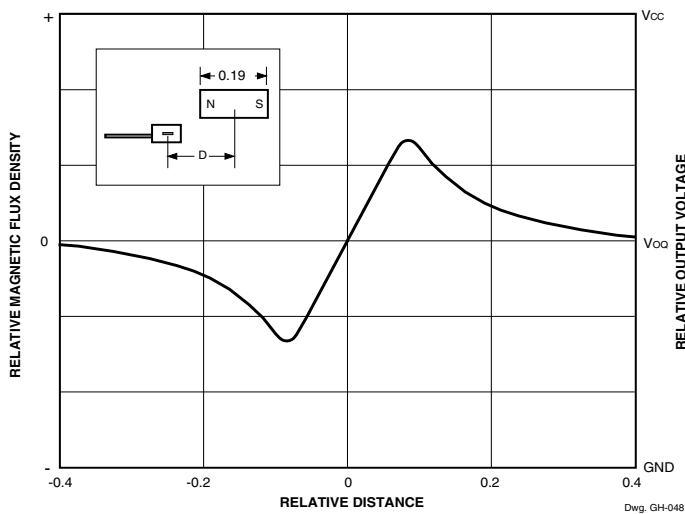
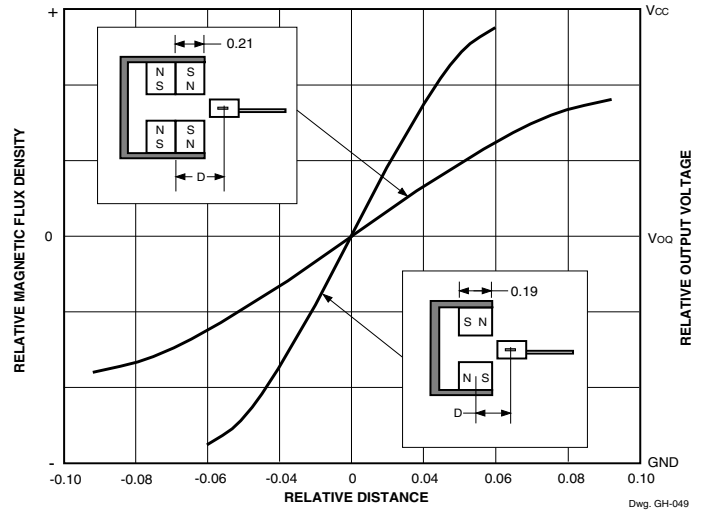
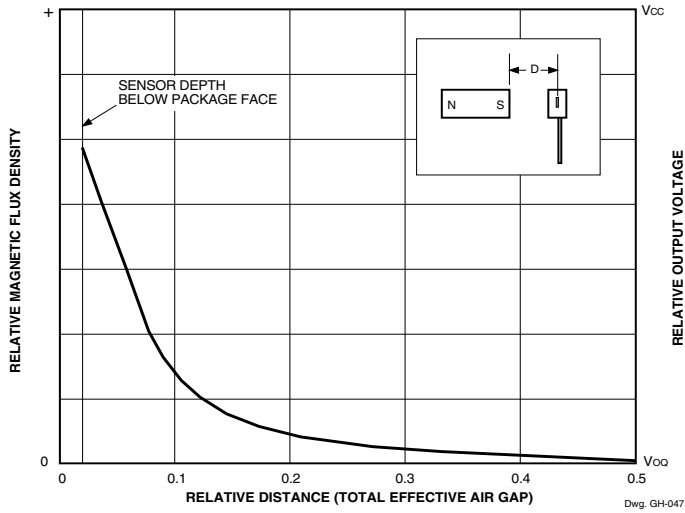

3507 AND 3508 RATIOMETRIC, LINEAR HALL-EFFECT SENSORS FOR HIGH-TEMP. OPERATION

Dimensions in Inches
(controlling dimensions)

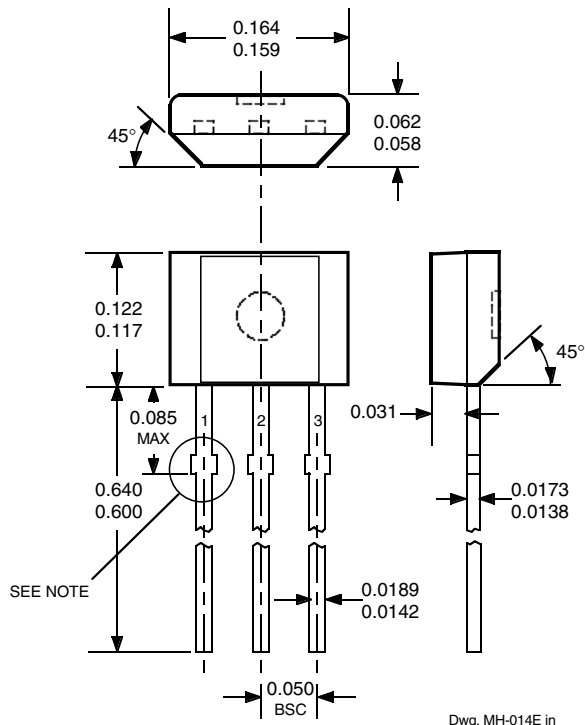

Dimensions in Millimeters
(for reference only)

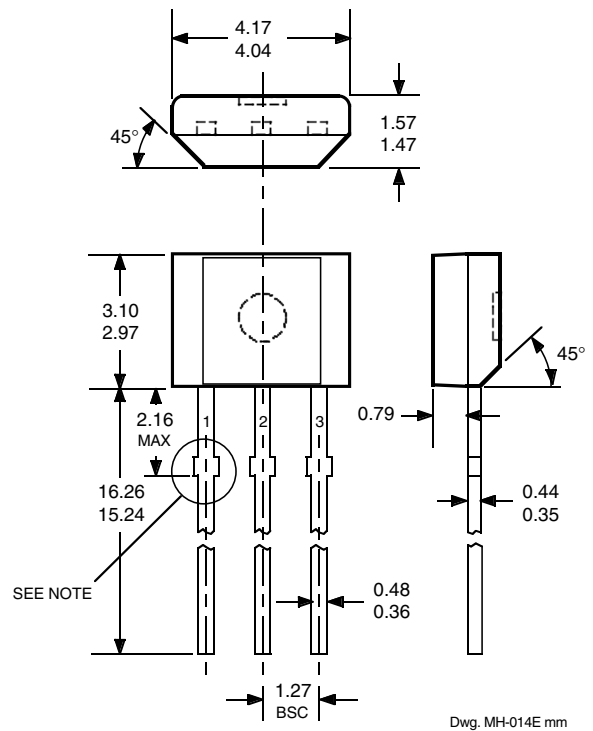

- NOTES:
1. Tolerances on package height and width represent allowable mold offsets. Dimensions given are measured at the widest point (parting line).
 2. Exact body and lead configuration at vendor's option within limits shown.
 3. Height does not include mold gate flash.
 4. Recommended minimum PWB hole diameter to clear transition area is 0.035" (0.89 mm).
 5. Where no tolerance is specified, dimension is nominal.

3507 AND 3508
RATIOMETRIC,
LINEAR HALL-EFFECT SENSORS
FOR HIGH-TEMP. OPERATION

HALL-EFFECT SENSORS

Partial Part Number	Avail. Oper. Temp.	Characteristics at T _A = +25°C			Features	Notes
		B _{OP} (max)	B _{RP} (min)	B _{hys} (typ)		
RATIOMETRIC, LINEAR HALL-EFFECT SENSORS						
3503	S		typ. 1.3 mV/G			
3507	E/L		typ. 2.5 mV/G			
3508	S		typ. 2.5 mV/G			
3515	E/L		typ. 5.0 mV/G		chopper stabilized	
3516	E/L		typ. 2.5 mV/G		chopper stabilized	
3517	L/S		typ. 5.0 mV/G		chopper stabilized	
3518	L/S		typ. 2.5 mV/G		chopper stabilized	
GEARTOOTH/RING MAGNET (DUAL ELEMENT) HALL-EFFECT SENSORS in order of B_{OP}						
3060	K/S	+35	-35	30	ac coupled	
3422	E/L	+75	-75	46	direction detection	
3059	K/S	+100	-100	130	ac coupled	
3056	E/L	+150	-150	50	zero-speed	
3058	E/L	+250	-250	200	zero-speed	
3421	E/L	+280	-280	335	direction detection	
SPECIAL-PURPOSE HALL-EFFECT SENSORS						
3054	K/S	+300	+5.0	50	unipolar switch, multiplexed	6
3150	J	+40 to +850	-	20	programmable, chopper stabilized	1
3210	E	±70	±5.0	7.7	micropower, chopper stabilized	
3421	E/L	+280	-280	335	direction detection	
3422	E/L	+85	-85	46	direction detection	

Operating Temperature Ranges:

S = -20°C to +85°C, E = -40°C to +85°C, J = -40°C to +115°C, K = -40°C to +125°C, L = -40°C to +150°C

Notes 1. Protected.

6. Multiplexed two-wire sensor; after proper address, power/signal bus current indicates magnetic field condition.

The products described herein are manufactured under one or more of the following U.S. patents: 5,045,920; 5,264,783; 5,442,283; 5,389,889; 5,581,179; 5,517,112; 5,619,137; 5,621,319; 5,650,719; 5,686,894; 5,694,038; 5,729,130; 5,917,320; and other patents pending.

Allegro MicroSystems, Inc. reserves the right to make, from time to time, such departures from the detail specifications as may be required to permit improvements in the performance, reliability, or manufacturability of its products. Before placing an order, the user is cautioned to verify that the information being relied upon is current.

Allegro products are not authorized for use as critical components in life-support appliances, devices, or systems without express written approval.

The information included herein is believed to be accurate and reliable. However, Allegro MicroSystems, Inc. assumes no responsibility for its use; nor for any infringements of patents or other rights of third parties that may result from its use.

