

## ISOLATED DC/DC CONVERTERS

36 Vdc - 75 Vdc Input 6.5 Vdc /60 A Output, 1/4 Brick



Aug. 09, 2010

*Bel Power Inc., a subsidiary of Bel Fuse Inc.*

**0RQB-Q2T06x**

**RoHS Compliant**

**Rev.G**

### Features

- Isolated
- High Efficiency
- High Power Density
- Fixed Frequency (300 kHz)
- Low Cost
- Input Under-Voltage Lockout
- Class 1, Category 2, Isolated DC/DC Converter (refer to IPC-9592)
- UL60950-1 Recognized (UL/cUL) (Pending)
- Output Over-Voltage Shutdown
- Over Temperature Protection
- OCP/SCP
- Remote On/Off
- Basic Insulation
- Input Over-Voltage Lockout

### Applications

- Networking
- Computers and peripherals
- Telecommunications

### Description

The 0RQB-Q2T06x is an isolated dc/dc converter that operates from a nominal 48 Vdc source. This unit will provide up to 390 W of output power from a nominal 48 Vdc input. This unit is designed to be highly efficient and low cost. Features include remote on/off, over current protection and under voltage lockout. The converter is provided in an industry standard quarter brick package.

### Part Selection

Output Voltage	Input Voltage	Max. Output Current	Max. Output Power	Typical Efficiency	Model Number Active High	Model Number Active Low
6.5 Vdc	36 Vdc - 75 Vdc	60 A	390 W	93.5%	0RQB-Q2T065	0RQB-Q2T06L

**Notes:** Add "G" suffix at the end of the model number to indicate Tray Packaging.

### Part Number Explanation

0 R QB - Q2 T 06 5  
1 2 3 4 5 6 7

1---Through hole

2---RoHS 6, change "R" to "7" means RoHS 5

3---Series name, 1/4 Brick

4---Series code

5---Input range 48V wide (36-75V)

6---Output voltage (6.5V)

7---Enable, "5" means active high, and "L" means active low

## ISOLATED DC/DC CONVERTERS

36 Vdc - 75 Vdc Input 6.5 Vdc /60 A Output, 1/4 Brick



Aug. 09, 2010

Bel Power Inc., a subsidiary of Bel Fuse Inc.

### Absolute Maximum Ratings

Parameter	Min	Typ	Max	Unit	Notes
Continuous Input Voltage	-0.3	-	80	V	
Input Transient Voltage	-	-	100	V	100 mS maximum
Remote On/Off	-0.3	-	18	V	
I/O Isolation Voltage	-	-	1500	V	
Ambient Temperature	-40	-	85	°C	
Storage Temperature	-55	-	125	°C	

**Note:** Ratings used beyond the maximum ratings may cause a reliability degradation of the converter or may permanently damage the device.

### Input Specifications

Parameter	Min	Typ	Max	Unit	Notes
Operating Input Voltage	36	48	75	V	
Input Current (full load)	-	-	15.3	A	
Input Current (no load)	-	140	180	mA	
Remote Off Input Current	-	15	20	mA	
Input Reflected Ripple Current (rms)	-	15	25	mA	Tested with simulated source impedance of 10 $\mu$ H, 5 Hz to 20 MHz; use a 220 $\mu$ F/100 V electrolytic capacitor with ESR = 1 ohm max. at 200 kHz at 25 °C.
Input Reflected Ripple Current (pk-pk)	-	50	80	mA	
I <sup>2</sup> t Inrush Current Transient	-	-	1	A <sup>2</sup> s	
Turn-on Voltage Threshold	-	34.5	35.8	V	
Turn-off Voltage Threshold	32	33.5	-	V	

**CAUTION:** This converter is not internally fused. An input line fuse must be used in application.

Recommend a fast-acting fuse with maximum rating of 20A on system board. Refer to the fuse manufacture's datasheet for further information.

**Notes:** 1. This converter has internal C-L-C (1 $\mu$ F-0.72 $\mu$ H-10.8 $\mu$ F) filter.

2. All specifications are typical at 25 °C unless otherwise stated.

### Output Specifications

Parameter	Min	Typ	Max	Unit	Notes
Output Voltage Set Point	6.37	6.50	6.63	V	Vin=48V, Io=50% load
Load Regulation	-	$\pm$ 15	$\pm$ 40	mV	
Line Regulation	-	$\pm$ 15	$\pm$ 32	mV	
Regulation Over Temperature (-40deg.C-85deg.C)	-	$\pm$ 30	$\pm$ 65	mV	
Ripple and Noise (pk-pk)	-	120	200	mV	0-20 MHz BW, with a 1 $\mu$ F ceramic capacitor and a 10 $\mu$ F Tantalum cap at output.
Ripple and Noise (rms)	-	30	50	mV	
Ripple and Noise (pk-pk) under worst case	-	-	300	mV	over all operating input voltage, load and temperature conditions.

# ISOLATED DC/DC CONVERTERS

36 Vdc - 75 Vdc Input 6.5 Vdc /60 A Output, 1/4 Brick



Aug. 09, 2010

Bel Power Inc., a subsidiary of Bel Fuse Inc.

## Output Specifications (continued)

Parameter	Min	Typ	Max	Unit	Notes	
Output Current Range	0	-	60	A		
Output DC Current Limit	64	72	81	A		
Short Circuit Surge Transient	-	-	6	A <sup>2</sup> s		
Rise time	-	20	-	ms		
Turn on Time		60	90	mS	Enable form Vin	
	-	40	70	mS	Enable form ON/OFF	
Overshoot at Turn on	-	0	3	%		
Output Capacitance	0	-	10000	uF		
<b>Transient Response</b>						
ΔV50%~75% of Max Load	Overshoot	-	-	400	mV	di/dt=0.1A/us, Vin=48Vdc, Ta=25°C, with a 1μF ceramic capacitor and a 10uF Tantalum cap at the output.
	Settling Time	-	-	300	uS	
ΔV75%~50% of Max Load	Overshoot	-	-	400	mV	
	Settling Time	-	-	300	uS	
ΔV50%~75% of Max Load	Overshoot	-	-	500	mV	di/dt=1A/us, Vin=48Vdc, Ta=25°C, with a 1μF ceramic capacitor and a 470uF Tantalum cap at the output.
	Settling Time	-	-	300	uS	
ΔV75%~50% of Max Load	Overshoot	-	-	500	mV	
	Settling Time	-	-	300	uS	

**Note:** All specifications are typical at nominal input, full load at 25°C unless otherwise stated.

## General Specifications

Parameter	Min	Typ	Max	Unit	Notes
Efficiency	-	93.5	-	%	Vin=48V, full load
Switching Frequency	-	300	-	kHz	
Over Temperature Protection	-	125	-	°C	
Over Voltage Protection(Static)	-	8	-	V	This voltage is achieved by trimming up output slowly
Weight	-	71	-	g	
FIT		478		-	Calculated Per Bell Core SR-332 (Vin=48V, Vo=6.5V, Io=30A, 500LFM, Ta = 25 °C, FIT=10 <sup>9</sup> /MTBF)
Dimensions					
Inches (L x W x H)		2.30 x 1.45 x 0.50		-	
Millimeters (L x W x H)		58.42 x 36.83 x 12.70			
<b>Isolation characteristics</b>					
Input to Output	-	-	1500	V	
Input to Case	-	-	1500	V	
Output to Case	-	-	500	V	
Isolation Resistance	10M	-		ohm	
Isolation Capacitance	-	2200	-	pF	

**Note:** All specifications are typical at 25 °C unless otherwise stated.

# ISOLATED DC/DC CONVERTERS

36 Vdc - 75 Vdc Input 6.5 Vdc /60 A Output, 1/4 Brick



Aug. 09, 2010

Bel Power Inc., a subsidiary of Bel Fuse Inc.

## Efficiency Data

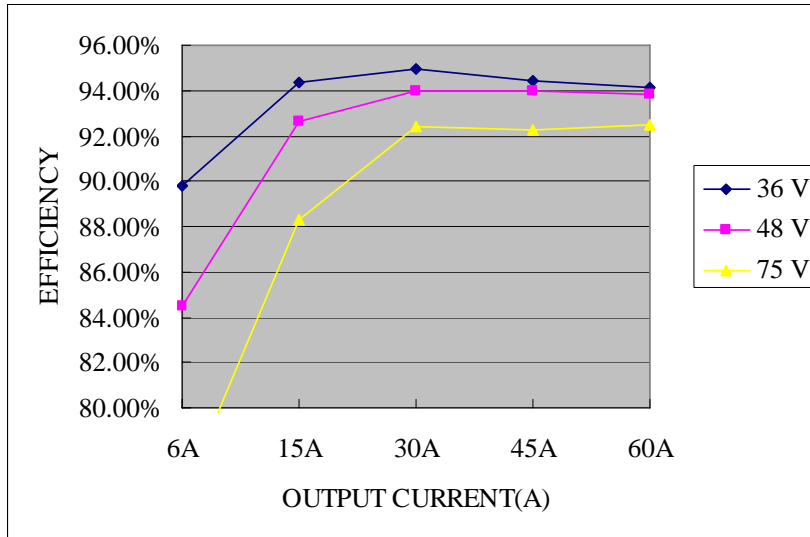

## Thermal Derating Curve

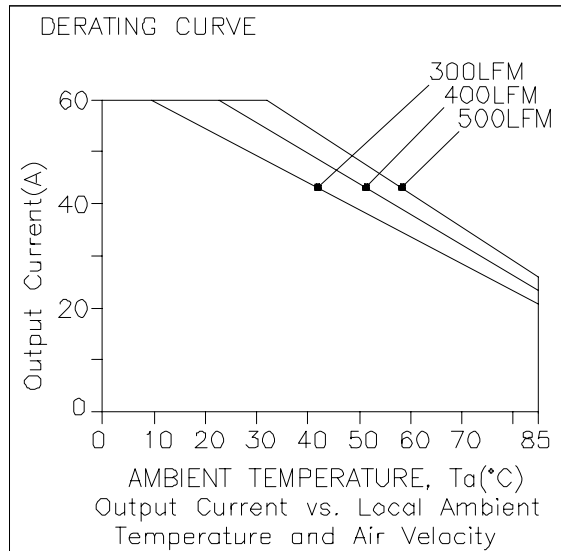
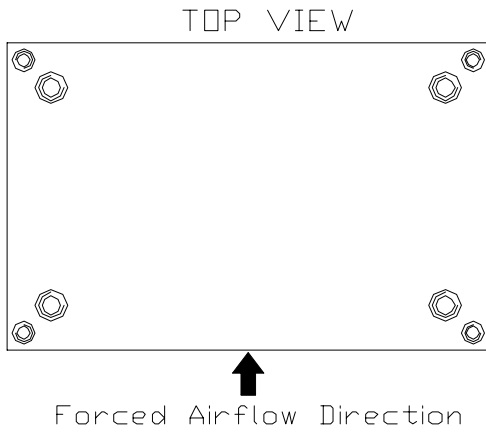

Derating curve under normal input

# ISOLATED DC/DC CONVERTERS

36 Vdc - 75 Vdc Input 6.5 Vdc /60 A Output, 1/4 Brick



Aug. 09, 2010

Bel Power Inc., a subsidiary of Bel Fuse Inc.

## Ripple and Noise Waveform

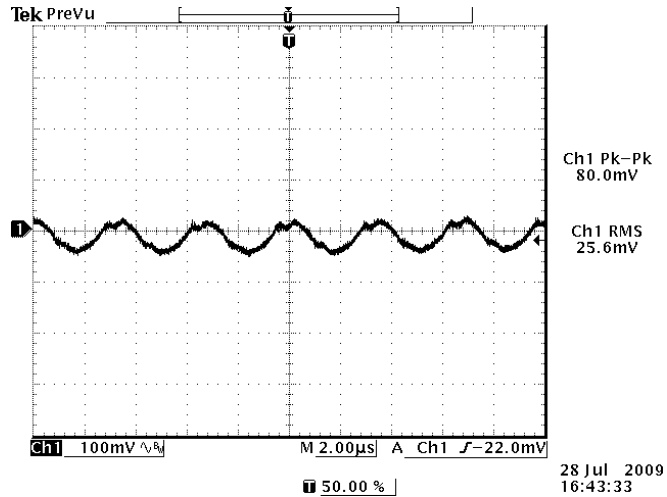

48Vdc input, 6.5Vdc/60A

**Note:** Ripple and noise at full load, and with a 1uF ceramic cap and a 10 uF Tantalum cap at output.

## Transient Response Waveforms

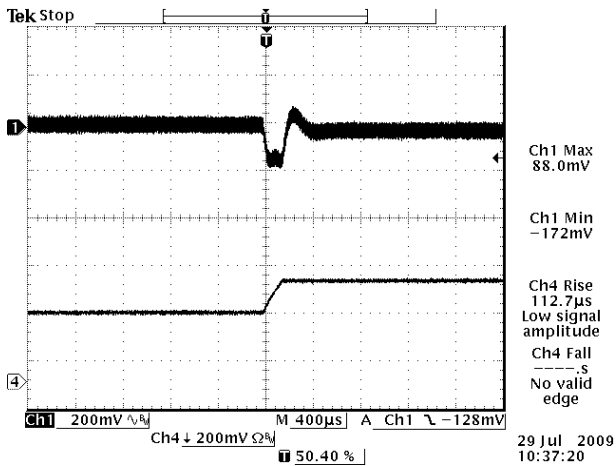

Vout= 6.5V 50%-75% Load Transients

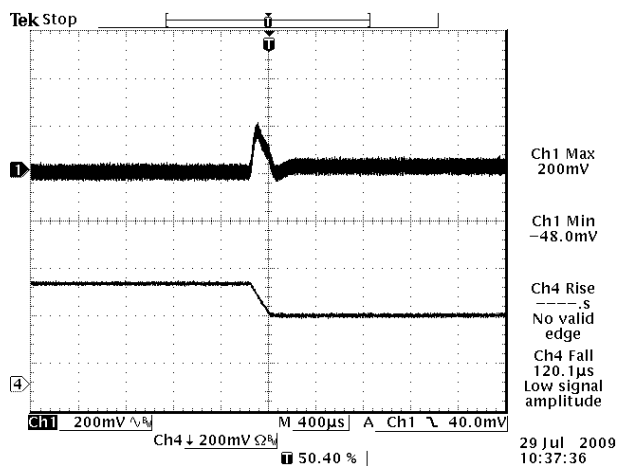

Vout= 6.5V 75%-50% Load Transients

**Note:** Transient Response at di/dt=0.1A/uS, with 1uF ceramic cap and 10uF aluminum cap at output.

# ISOLATED DC/DC CONVERTERS

36 Vdc - 75 Vdc Input 6.5 Vdc /60 A Output, 1/4 Brick



Aug. 09, 2010

Bel Power Inc., a subsidiary of Bel Fuse Inc.

## Startup & Shutdown

### Rise time

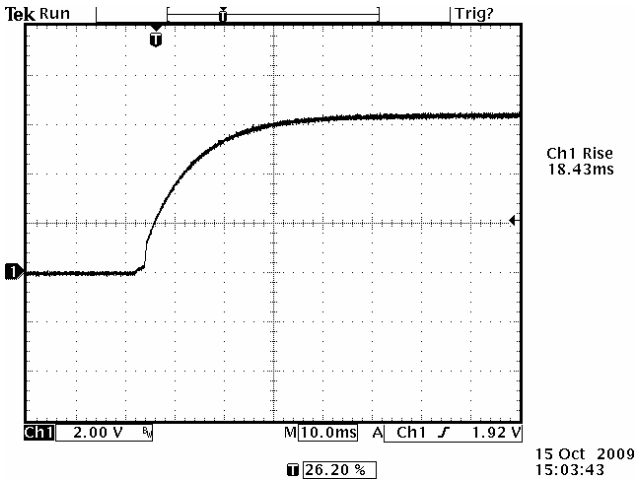

Vout= 6.5V/60A at Vin=48V@Ta=25°C  
Cext = 0uF

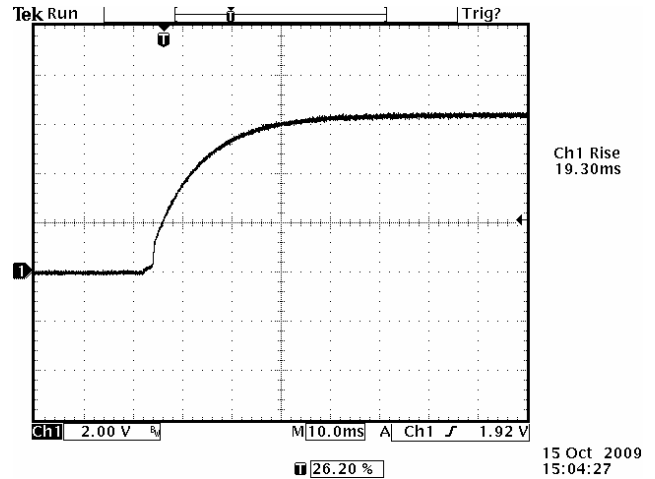

Vout= 6.5V/60A at Vin=48V@Ta=25°C  
Cext = 10000uF

### Startup time

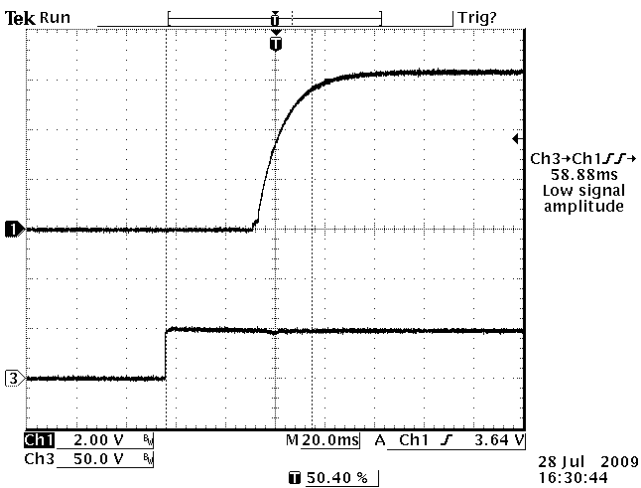

Startup from Vin  
Ch1: Vo  
Ch3: Vin  
Vout= 6.5V/60A at Vin=48V@Ta=25°C  
Cext = 10000uF

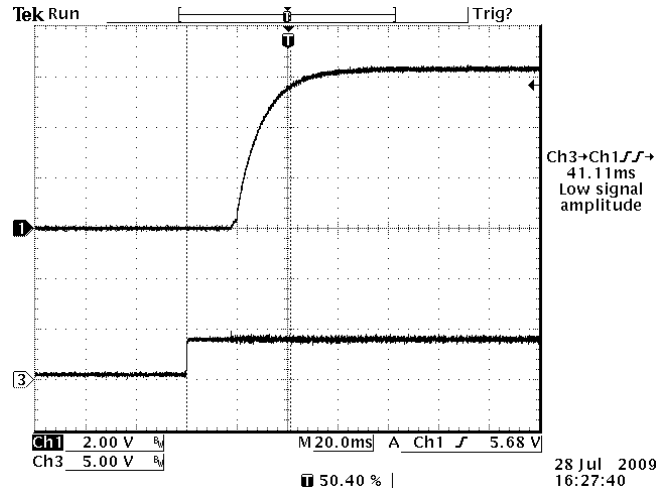

Startup from on/off  
Ch1: Vo  
Ch3: on/off  
Vout= 6.5V/60A at Vin=48V@Ta=25°C  
Cext = 10000uF

# ISOLATED DC/DC CONVERTERS

36 Vdc - 75 Vdc Input 6.5 Vdc /60 A Output, 1/4 Brick



Aug. 09, 2010

Bel Power Inc., a subsidiary of Bel Fuse Inc.

## Startup & Shutdown (continued)

### Shutdown

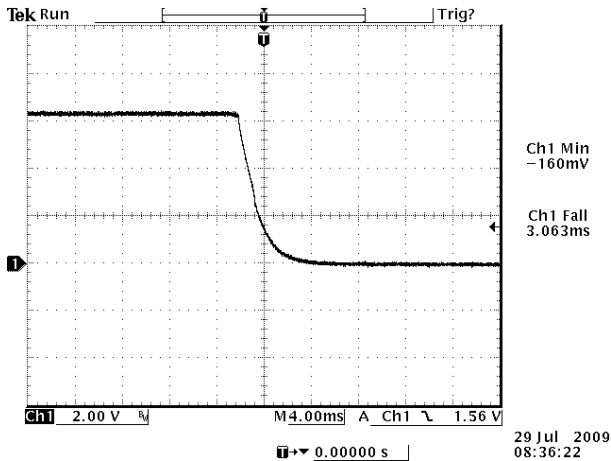

$V_{out} = 6.5V/60A$  at  $V_{in} = 48V @ T_a = 25^\circ C$

$C_{ext} = 10000\mu F$

## Over Current Protection

To provide protection in a fault output overload condition, the module is equipped with internal current-limiting circuitry and can endure current limiting for a few milli-seconds. If the over current condition persists beyond a few milliseconds, the module will shut down into hiccup mode and restart once every 400mS. The module operates normally when the output current goes into specified range. The typical average output current is 5A during hiccup.

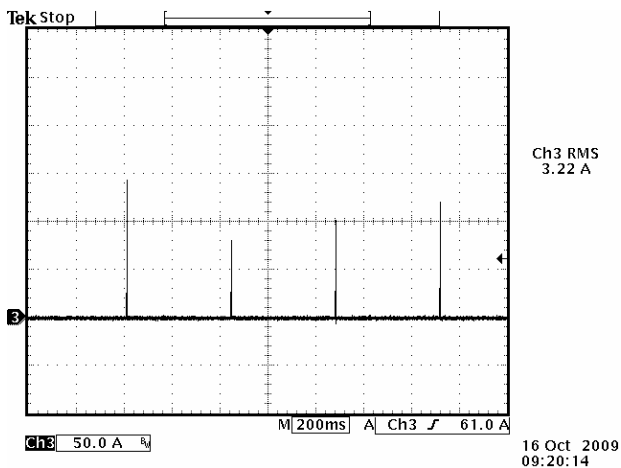

output current waveform

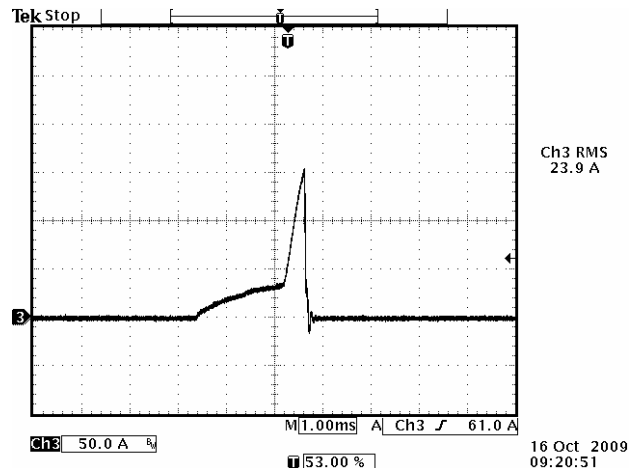

Expansion of on time portion

# ISOLATED DC/DC CONVERTERS

36 Vdc - 75 Vdc Input 6.5 Vdc /60 A Output, 1/4 Brick



Aug. 09, 2010

Bel Power Inc., a subsidiary of Bel Fuse Inc.

## Over Voltage Protection

The output overvoltage protection consists of circuitry that monitors the voltage on the output terminals. If the voltage on the output terminals exceeds the over voltage protection threshold the module will shutdown into latch off mode. The overvoltage latch can be reset by either cycling the input power or toggling the on/off signal for one second at least.

Test setup:

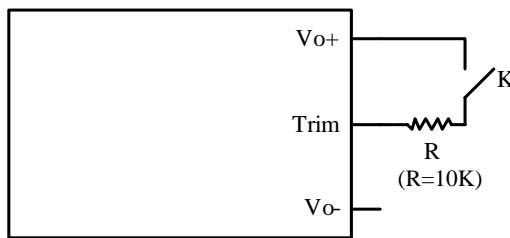

R is the ohmic value of the resistor used for the overvoltage test

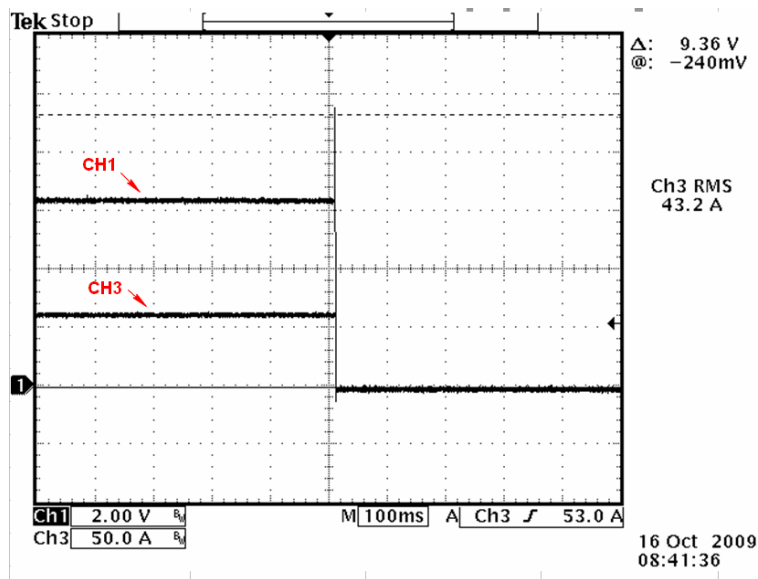

CH1: Output voltage waveform  
CH3: Output Current waveform

Aug. 09, 2010

*Bel Power Inc., a subsidiary of Bel Fuse Inc.*

## Over Temperature Protection

The OTP is achieved by thermistor R60 and the threshold is set at 105C in non-latch mode; the hottest component Q2 reaches 120C with 500LFM air flow correspondingly. It will restart automatically when the temperature falls down to 100C. The protecting point will be varied a little under different conditions (air flow, ambient temperature, input voltage, load...).

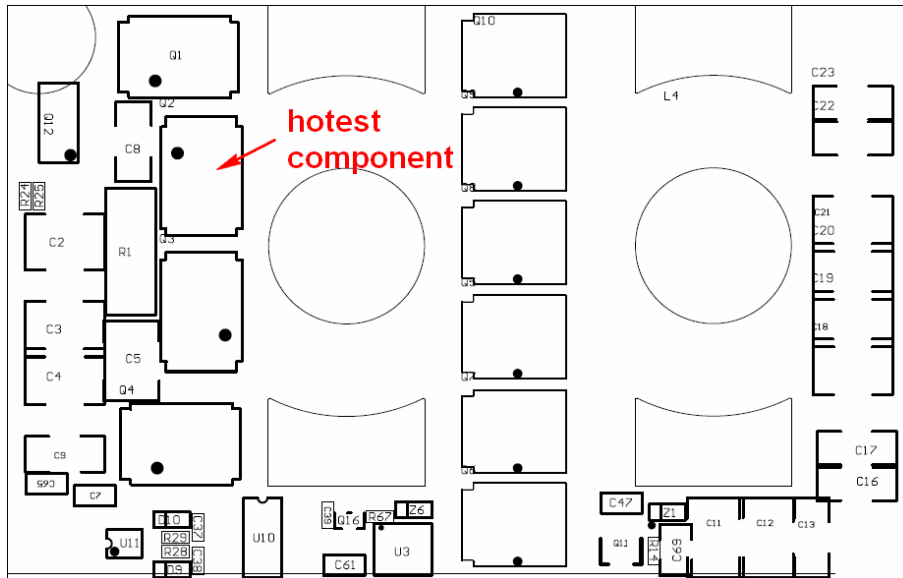

The hottest component on the top side: Q2

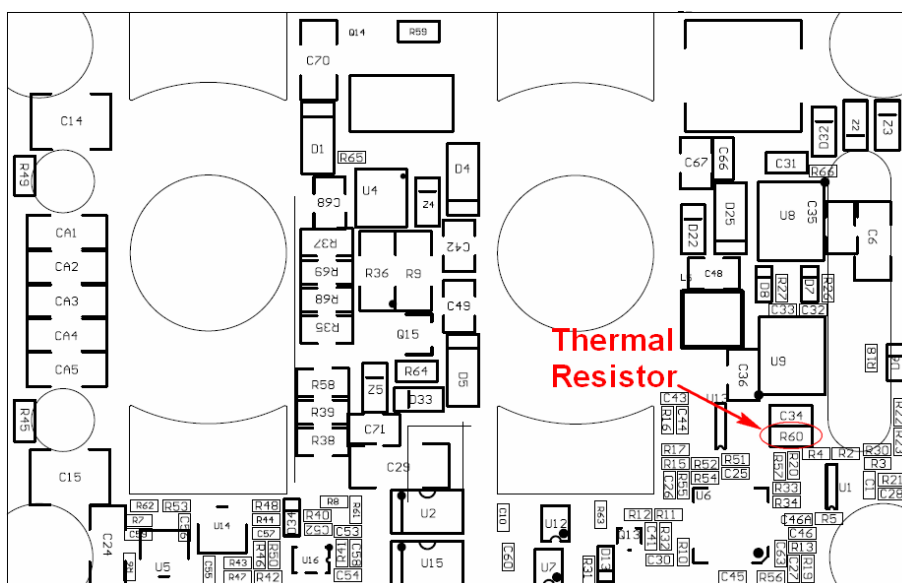

The thermistor on the bottom side: R60

# ISOLATED DC/DC CONVERTERS

36 Vdc - 75 Vdc Input 6.5 Vdc /60 A Output, 1/4 Brick



Aug. 09, 2010

Bel Power Inc., a subsidiary of Bel Fuse Inc.

## Remote On/Off

Parameter		Min	Typ	Max	Unit	Notes
Signal Low (Unit On)	Active Low	-0.3	-	0.8	V	0RQB-Q2T06L. The remote on/off pin open, Unit off.
Signal High (Unit Off)		2.4	-	18	V	
Signal Low (Unit Off)	Active High	-0.3	-	0.8	V	0RQB-Q2T065. The remote on/off pin open, Unit on.
Signal High (Unit On)		2.4	-	18	V	
Current Sink		0	-	1	mA	

### Recommended remote on/off circuit for active low

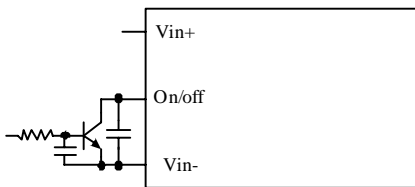

Control with open collector/drain circuit

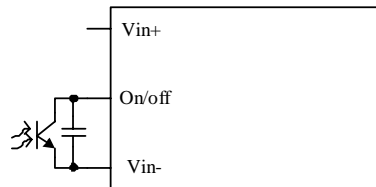

Control with photocoupler circuit

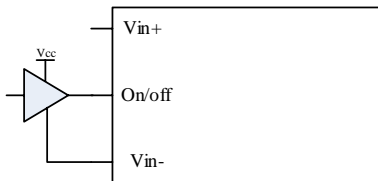

Control with logic circuit

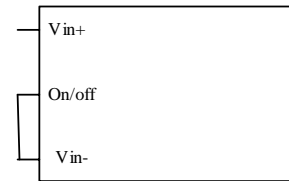

Permanently on

### Recommended remote on/off circuit for active high

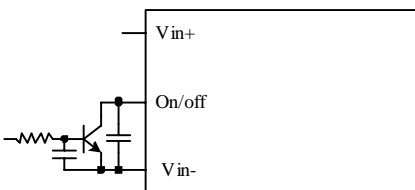

Control with open collector/drain circuit

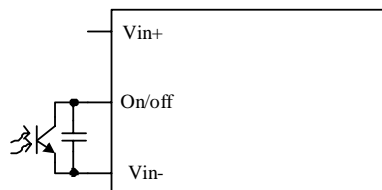

Control with photocoupler circuit

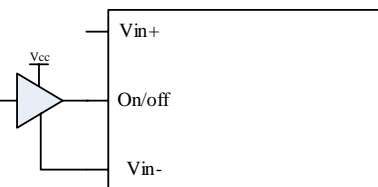

Control with logic circuit

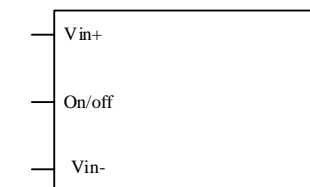

Permanently on

# ISOLATED DC/DC CONVERTERS

36 Vdc - 75 Vdc Input 6.5 Vdc /60 A Output, 1/4 Brick



Aug. 09, 2010

Bel Power Inc., a subsidiary of Bel Fuse Inc.

## Input Under-voltage Lockout

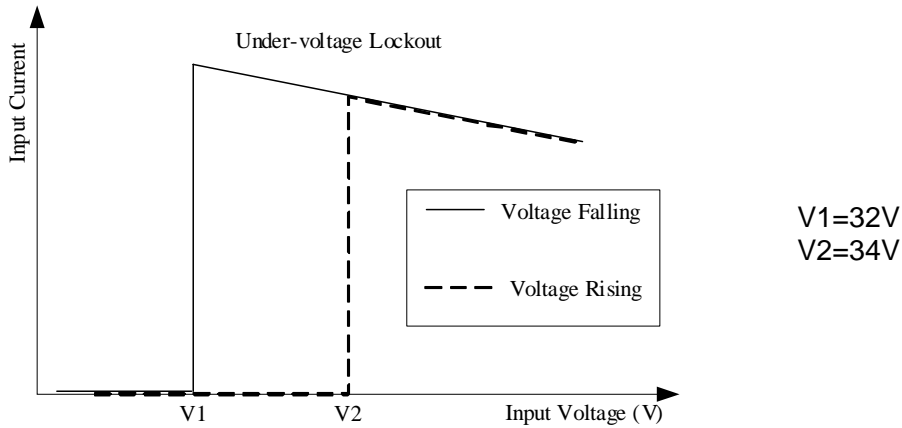

## Safety & EMC

### Safety

1. Material flammability UL94V-0
2. TUV Certification EN60950-1
3. UL Certification UL60950-1

### EMC

1. Surge IEC61000-4-5
2. DC-DIP IEC61000-4-29
3. Conductive EMI EN55022 class A

Compliance to EN55022 class A (both a.peak and average) with the following inductive and capacitive filter

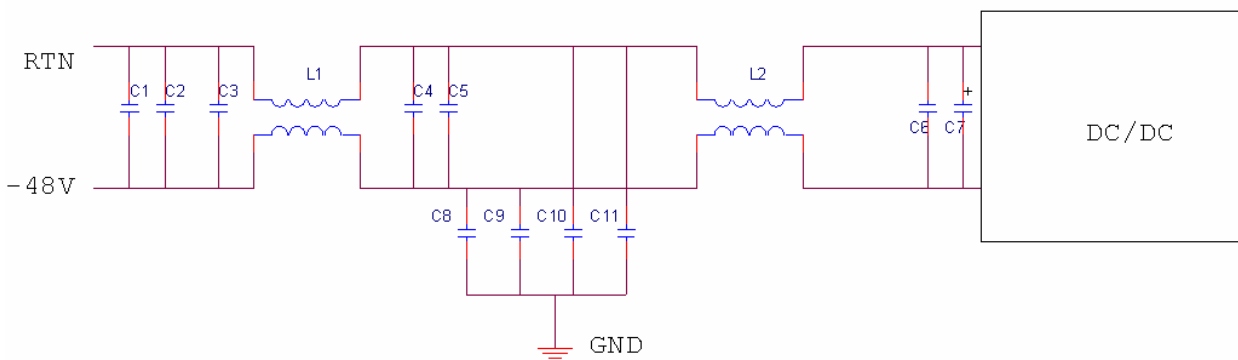

Item	Designator	Parameter
1	C1、C2、C3、C4、C5	100V/1000nF/X7R/1210
2	C6	100V/100nF/±10%/X7R/1206
3	C8、C9、C10、C11	0.22U/630V/X7R/2220
4	C7、C12	N/A
5	L1、L2	473uH/±25%/14A

# ISOLATED DC/DC CONVERTERS

36 Vdc - 75 Vdc Input 6.5 Vdc /60 A Output, 1/4 Brick



Aug. 09, 2010

Bel Power Inc., a subsidiary of Bel Fuse Inc.

## Safety & EMC (continued)

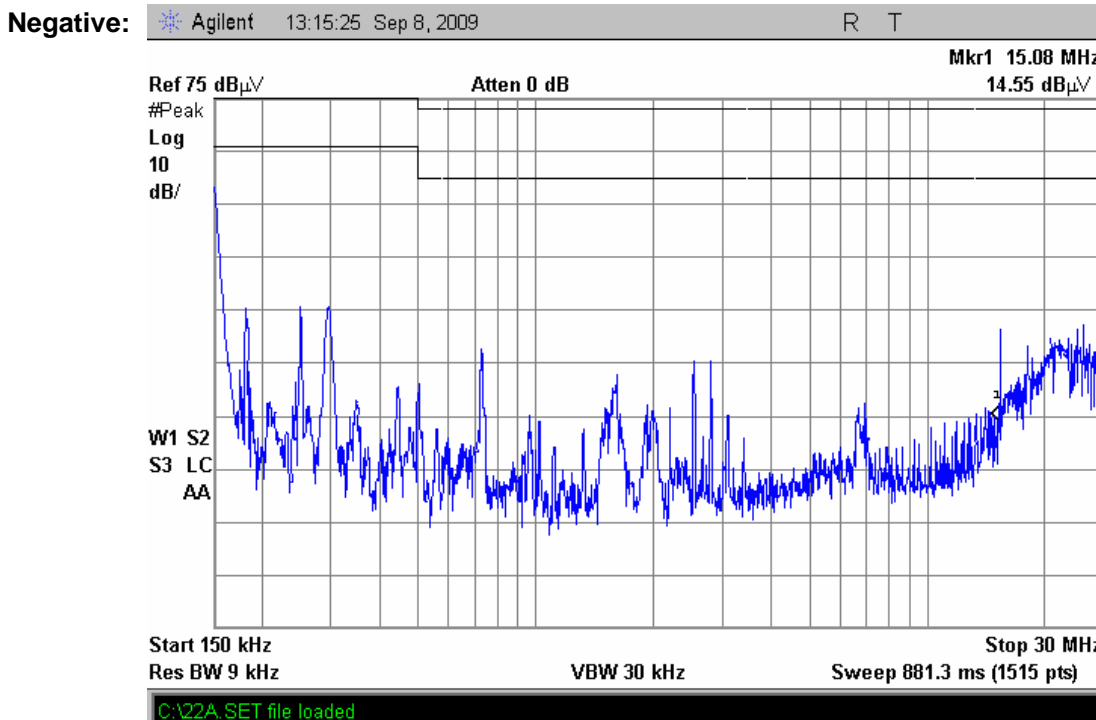
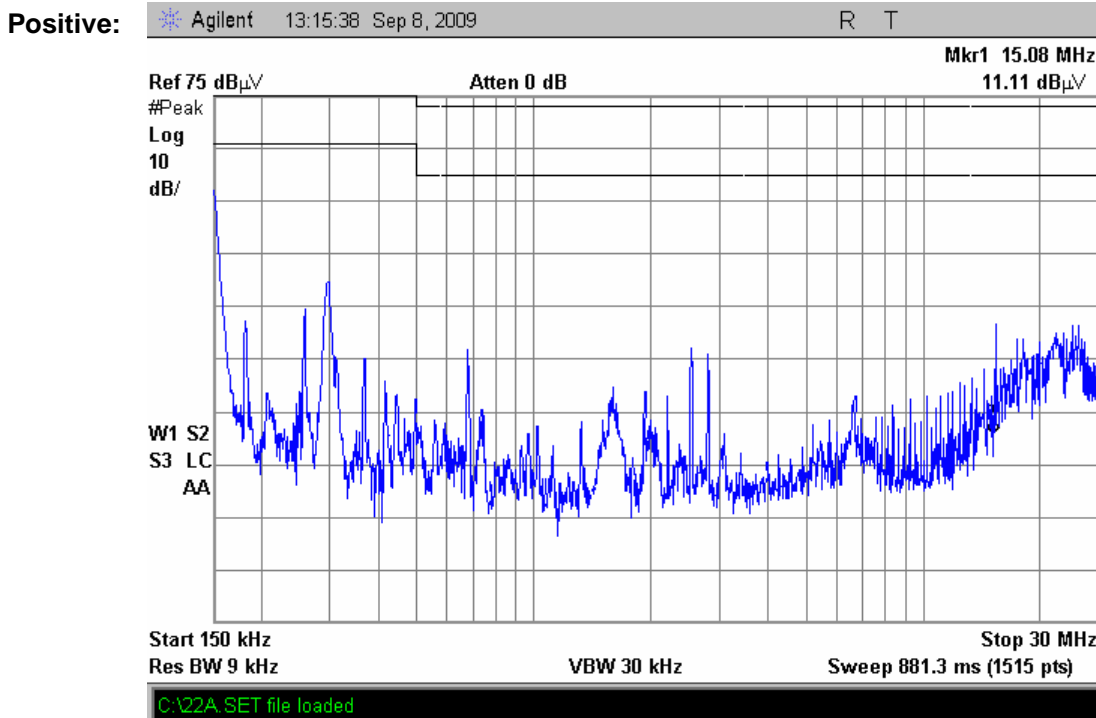

# ISOLATED DC/DC CONVERTERS

36 Vdc - 75 Vdc Input 6.5 Vdc /60 A Output, 1/4 Brick



Aug. 09, 2010

*Bel Power Inc., a subsidiary of Bel Fuse Inc.*

## Layout

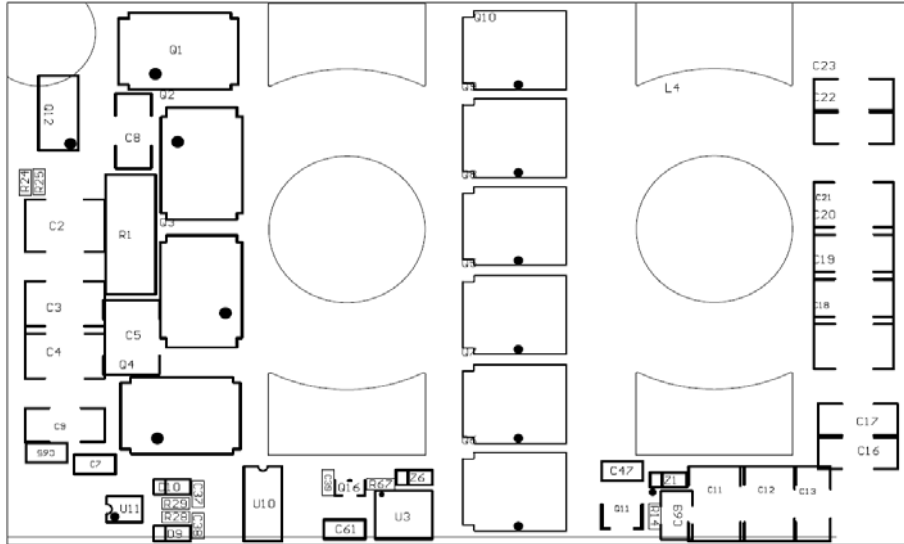

Layout of components on top side



Layout of components on bottom side

# ISOLATED DC/DC CONVERTERS

36 Vdc - 75 Vdc Input 6.5 Vdc /60 A Output, 1/4 Brick



Aug. 09, 2010

Bel Power Inc., a subsidiary of Bel Fuse Inc.

## Mechanical Outline

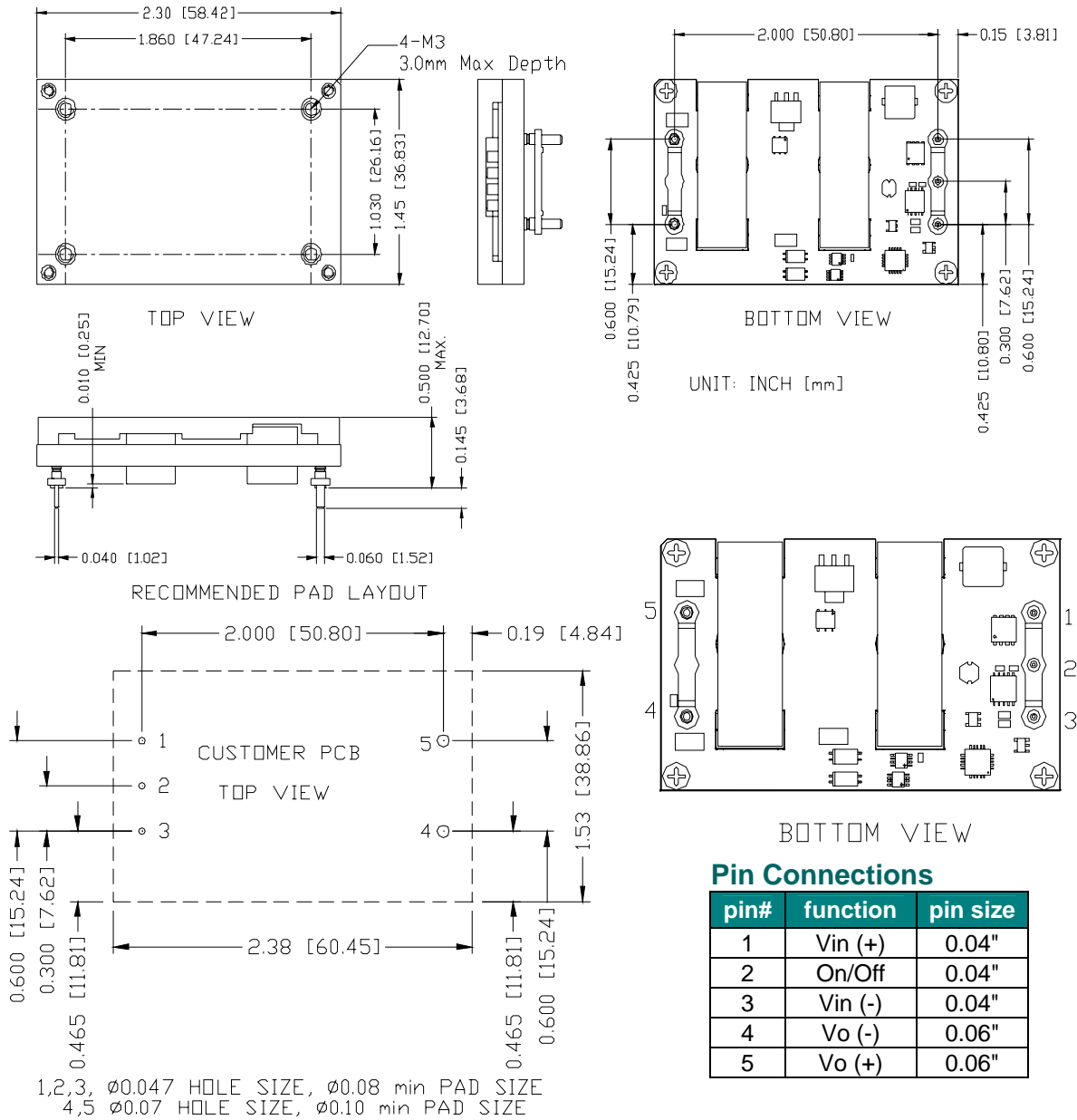

**Note:** This module is recommended and compatible with Pb-Free Wave Soldering and must be soldered using a peak solder temperature of no more than 260 °C for less than 5 seconds.

### Note:

- 1) All Pins: Material - Copper Alloy;  
Finish – 3 micro inches minimum Gold over 50 micro inches minimum Nickel plate.
- 2) Undimensioned components are shown for visual reference only.
- 3) All dimensions in inches (mm); Tolerances: x.xx +/-0.02 in. (x.x +/-0.5mm) x.xxx +/-0.010 in. (x.xx +/-0.25mm).

## ISOLATED DC/DC CONVERTERS

36 Vdc - 75 Vdc Input 6.5 Vdc /60 A Output, 1/4 Brick



Aug. 09, 2010

Bel Power Inc., a subsidiary of Bel Fuse Inc.

### Revision History

Date	Revision	Changes Detail	Approval
2009-06-16	A	First release	Joe Wei
2009-06-23	B	Delete output trim and remote sense function, update mechanical drawing	Joe Wei
2009-06-30	C	1. Update input C-L-C filter; 2. Change Max output cap form 5600uF to 10000uF; 3. Add transient response of di/dt=1A/us; 4. Change output current from 65A to 60A.	Joe Wei
2009-09-25	D	1.Change Switching frequency from 250K to 300K, 2.No load Input current. 3.remote off input current. 4.load regulation. 5.line regulation. 6.regulation over temperature. 7.Output DC current limit. 8.Turn on time. 9.Rise time. 10.Add efficiency, TD,NR,TR	YP Zhou
2009-10-19	E	1.Add I <sup>2</sup> t Inrush Current Transient; 2.Add Short Circuit Surge Transient; 3.Add MTBF data; 4.Update Derating curve under normal input; 5. Add OCP,OVP, OTP, Safety&EMC	YP Zhou
2009-10-23	F	1. Update test condition of MTBF; 2. Update waveform for OVP	YP Zhou
2010-03-02	G	Update mechanical drawing.	JZ Wang
2010-08-09	H	1. Update operating input current, turn on voltage threshold, turn off voltage threshold and input C-L-C filter in input specifications. 2. Update load regulation, output DC current limit and turn on time in output specifications. 3. Add Layout.	JZ Wang

### RoHS Compliance

Complies with the European Directive 2002/95/EC, calling for the elimination of lead and other hazardous substances from electronic products.



©2010 Bel Fuse Inc. Specifications subject to change without notice. 080910

15

#### CORPORATE

Bel Fuse Inc.  
206 Van Vorst Street  
Jersey City, NJ 07302  
Tel 201-432-0463  
Fax 201-432-9542  
[www.belfuse.com](http://www.belfuse.com)

#### FAR EAST

Bel Fuse Ltd.  
8F/ 8 Luk Hop Street  
San Po Kong  
Kowloon, Hong Kong  
Tel 852-2328-5515  
Fax 852-2352-3706  
[www.belfuse.com](http://www.belfuse.com)

#### EUROPE

Bel Fuse Europe Ltd.  
Preston Technology Management Centre  
Marsh Lane, Suite G7, Preston  
Lancashire, PR1 8UD, U.K.  
Tel 44-1772-556601  
Fax 44-1772-888366  
[www.belfuse.com](http://www.belfuse.com)