

METAL CASE, CASE-MOUNTED SEMICONDUCTORS

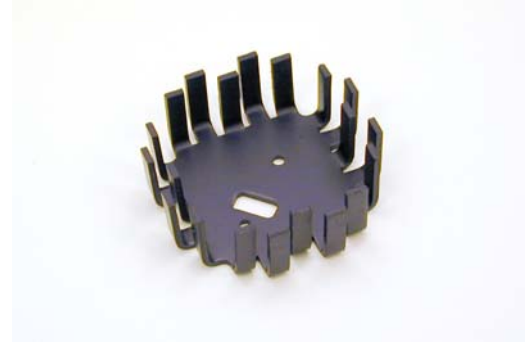

HP3 Series for Single TO-3 or Stud Mount

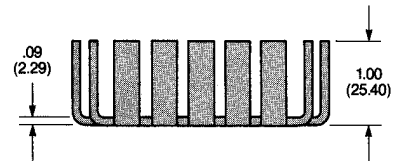
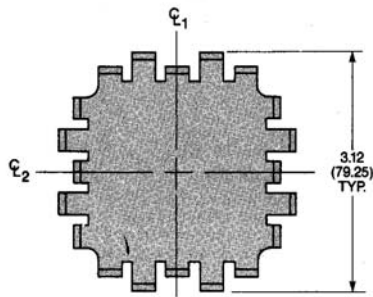

HP3-T03-CB w/2N3055 (TO-3) TRANSISTOR

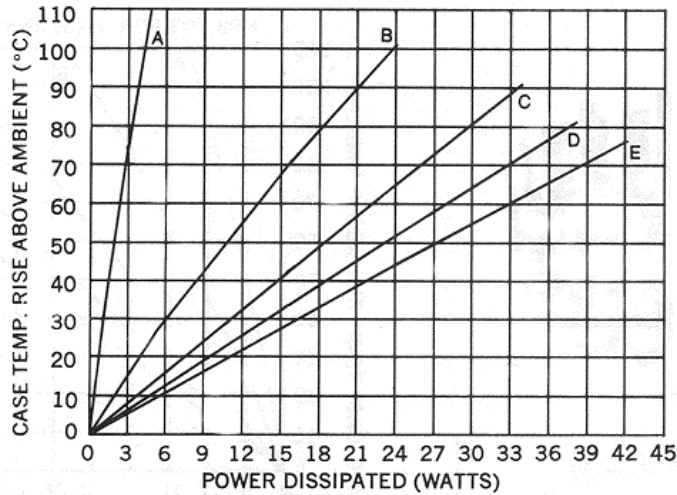

DESCRIPTION OF CURVES

- A. N.C. Horiz. Device Only Mounted to G-10.
- B. N.C. Horiz. & Vert. With Dissipator.
- C. 200 FPM w/Diss.
- D. 500 FPM w/Diss.
- E. 1000 FPM w/Diss.

- Thermal Resistance Case to Sink is 0.1-0.3 °C/W w/Joint Compound.
- Derate 1.0 °C/watt for unplated part in natural convection only.

Ordering Information

CTS IERC PART NO.			Semiconductor Accommodated	Hole patt. ref. no.	Max. Weight (Grams)
Unplated	Comm'l. Black Anodize	Mil. Black Anodize			
HP3-000-U	HP3-000-CB	HP3-000-B	Undrilled	--	55.0
HP3-T03-U	HP3-T03-CB	HP3-T03-B	T0-3	16	55.0
HP3-T03-33U	HP3-T03-33CB	HP3-T03-33B	T0-3 IC	17	55.0

HP3-T03-44U	HP3-T03-44CB	HP3-T03-44B	T0-3 PANEL MOUNT	31	55.0
HP3-436-U	HP3-436-CB	HP3-436-B	T0-3 (4 PIN)	18	55.0
HP3-T015-U	HP3-T015-CB	HP3-T015-B	T0-15, D0-5	23	55.0
HP3-T06-U	HP3-T06-CB	HP3-T06-B	T0-6, T0-36	19	55.0
HP3-420-U	HP3-420-CB	HP3-420-B	UNIVERSAL	27	55.0

HP3 for Dual TO-3 Outline

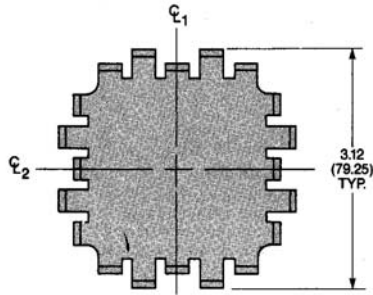

HP3-T03-4CB w/(2) 2N3055 (TO-3) TRANSISTORS

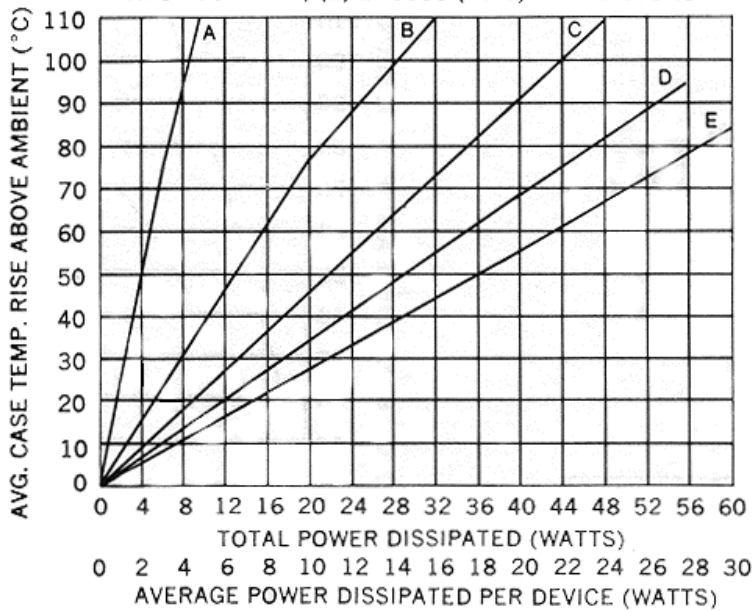

DESCRIPTION OF CURVES

- A. N.C. Horiz. Device Only Mounted to G-10.
- B. N.C Horiz. & Vert. With Dissipator.
- C. 200 FPM w/Diss.
- D. 500 FPM w/Diss.
- E. 1000 FPM w/Diss.

- Thermal Resistance Case to Sink is 0.1-0.3 °C/W w/Joint Compound.
- Derate 2.0 °C/watt for unplated part in natural convection only.

Ordering Information

CTS IERC PART NO.			Semiconductor Accommodated	Hole patt. ref. no.	Max. Weight (Grams)
Unplated	Comm'l. Black Anodize	Mil. Black Anodize			
HP3-T03-4U	HP3-T03-4CB	HP3-T03-4B	Two TO-3s	6	55.0
HP3-437-U	HP3-437-CB	HP3-437-B	Two TO-3s (4 pin)	12	55.0

HP3 for Three TO-3 Outline

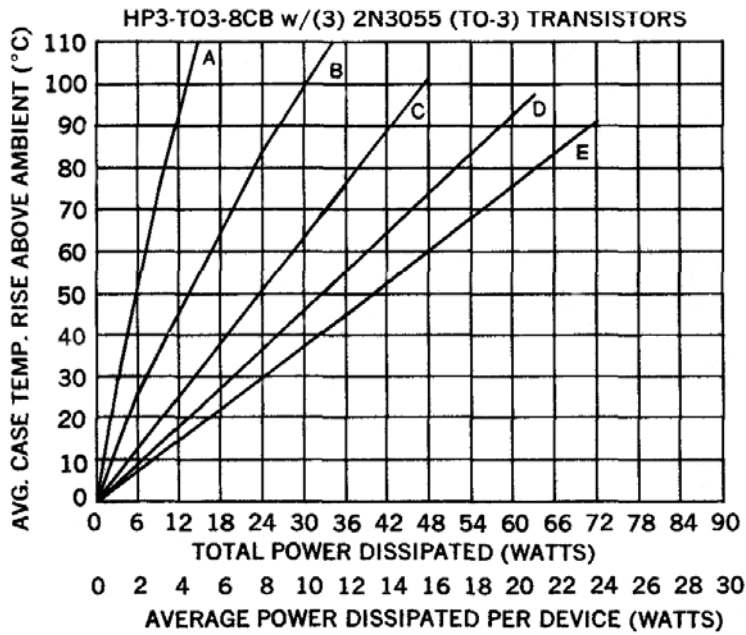
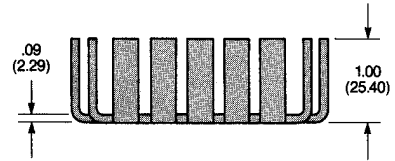
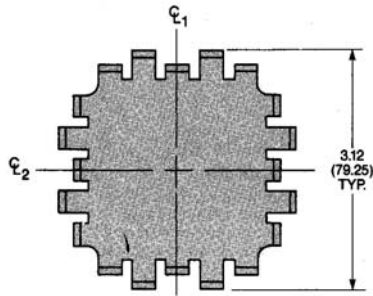

DESCRIPTION OF CURVES

- A. N.C. Horiz. Device Only Mounted to G-10.
- B. N.C Horiz. & Vert. With Dissipator.
- C. 200 FPM w/Diss.
- D. 500 FPM w/Diss.
- E. 1000 FPM w/Diss.

- Thermal Resistance Case to Sink is 0.1-0.3 °C/W w/Joint Compound.
- Derate 3.0 °C/watt for unplated part in natural convection only.

Ordering Information

CTS IERC PART NO.			Semiconductor Accommodated	Hole patt. ref. no.	Max. Weight (Grams)
Unplated	Comm'l. Black Anodize	Mil. Black Anodize			
HP3-T03-8U	HP3-T03-8CB	HP3-T03-8B	Three TO-3s	13	55.0

HOLE PATTERNS

6. Hole pattern no. 124 accomodates two TO-3s. Available in HP3 series heat dissipators only.

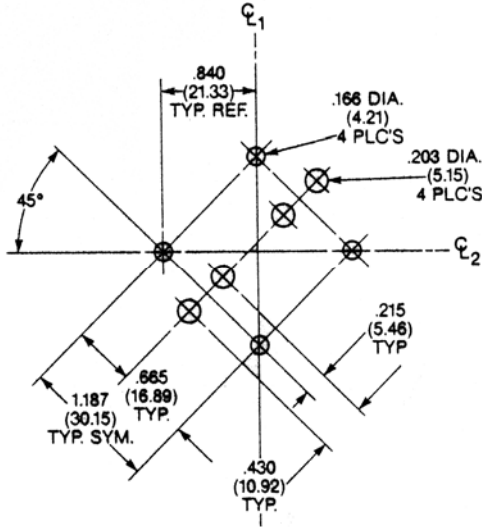

12. Hole pattern no. 437 accomodates two TO-3s (4-pin). Available in HP3 series heat dissipators only.

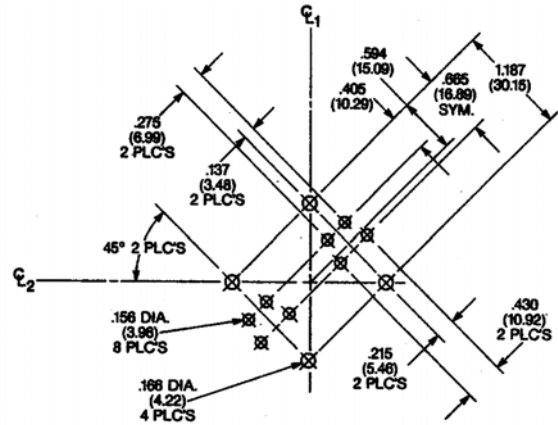

13. Hole pattern no. 186 accomodates three TO-3s. Available in HP3 series heat dissipators only.

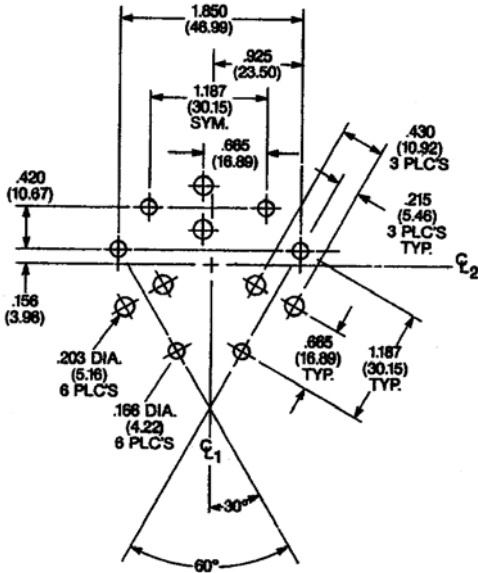

16. Hole pattern no. 1 accomodates T0-3s. Available in UP, UP1, UP2, HP1, and HP3 series heat dissipators.

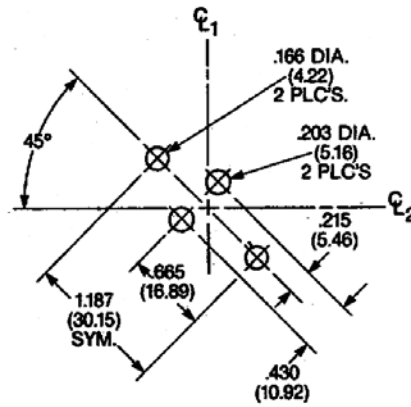

17. Hole pattern no. 202 accommodates T0-3 ICs. Available in UP, UP1, UP2, HP1, and HP3 series heat dissipators.

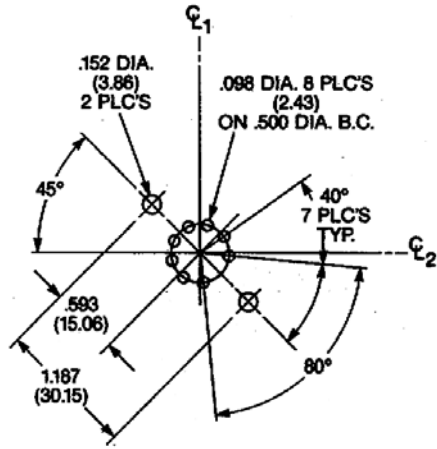

18. Hole pattern no. 436 accommodates T0-3s (4-pin). Available in UP, UP1, UP2, HP1, and HP3 series heat dissipators.

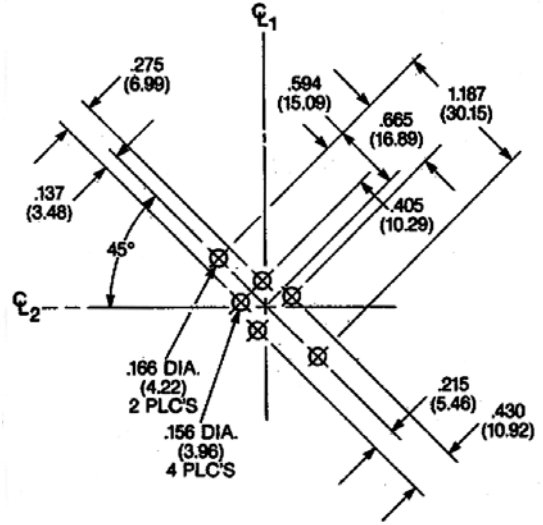

19. Hole pattern no. 2 accommodates T0-6s or T0-36s. Available in UP, UP1, UP2, HP1, and HP3 series heat dissipators.

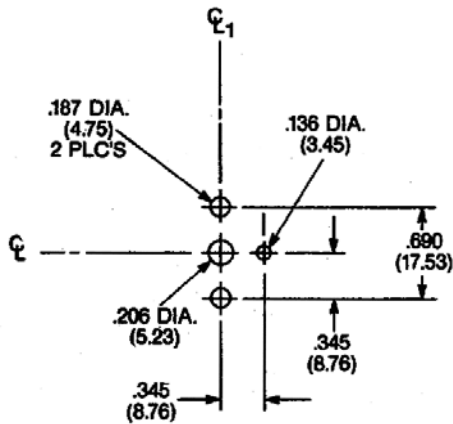

23. Hole pattern no. 3 accommodates T0-15s, D0-5s and other 1/4" stud mount devices. Available in UP, UP1, UP2, HP1, and HP3 series heat dissipators.

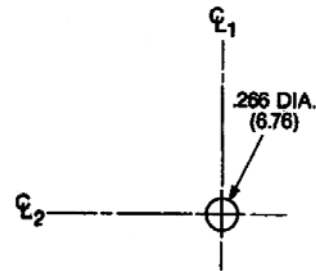

27. Hole pattern no. 420 (Universal) accommodates T0-3s, T0-66s, T0-126s, T0-127s, or T0-220s. Available in UP, UP1, UP2, HP1, and HP3 series heat dissipators.

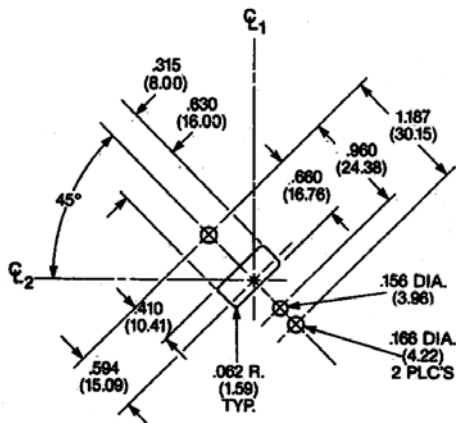

31. Hole pattern no. 213 accommodates one TO-3 (panel mounted). Available in HP1 and HP3 series heat dissipators only.

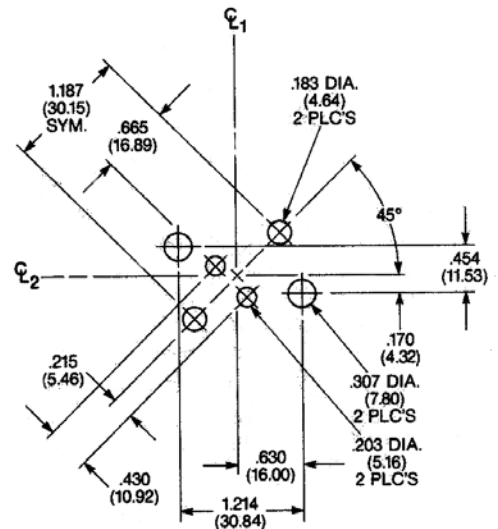

CTS IERC, Heat Sinks and Thermal Management Solutions

413 North Moss Street, Burbank, California 91502 Tel: (818) 842-7277 Fax: (818) 848-8872

Rev. 04-13-04