

LED NUMERIC DISPLAY, 1 DIGIT
BL-S100X-12XX
Features:

- 25.40mm (1.0") Single digit numeric display series, BI-COLOR TYPE
- Low current operation.
- Excellent character appearance.
- Easy mounting on P.C. Boards or sockets.
- I.C. Compatible.
- ROHS Compliance.

Electrical-optical characteristics: (Ta=25°C) (Test Condition: IF=20mA)

Part No		Chip			VF Unit:V		Iv TYP.(mcd)
Common Cathode	Common Anode	Emitted Color	Material	λ_p (nm)	Typ	Max	
BL-S100A-12SG-XX	BL-S100B-12SG-XX	Super Red	AlGaInP	660	2.10	2.50	80
		Green	GaP/GaP	570	2.20	2.50	92
BL-S100A-12EG-XX	BL-S100B-12EG-XX	Orange	GaAsP/GaP	635	2.10	2.50	92
		Green	GaP/GaP	570	2.20	2.50	92
BL-S100A-12DUG-X X	BL-S100B-12DUG-X X	Ultra Red	AlGaInP	660	2.10	2.50	120
		Ultra Green	AlGaInP	574	2.20	2.50	120
BL-S100A-12UEUG- XX	BL-S100B-12UEUG- XX	Ultra Orange	AlGaInP	630	2.10	2.50	95
		Ultra Green	AlGaInP	574	2.20	2.50	120

-XX: Surface / Lens color:

Number	0	1	2	3	4	5
Ref Surface Color	White	Black	Gray	Red	Green	
Epoxy Color	Water clear	White diffused	Red Diffused	Green Diffused	Yellow Diffused	

Absolute maximum ratings (Ta=25°C)

Parameter	S	G	E	D	UG	UE		U nit
Forward Current I_F	30	30	30	30	30	30		mA
Power Dissipation P_d	75	80	80	75	75	65		mW
Reverse Voltage V_R	5	5	5	5	5	5		V
Peak Forward Current I_{PF} (Duty 1/10 @1KHZ)	150	150	150	150	150	150		mA
Operation Temperature T_{OPR}	-40 to +80							°C
Storage Temperature T_{STG}	-40 to +85							°C
Lead Soldering Temperature T_{SOL}	Max.260±5°C for 3 sec Max. (1.6mm from the base of the epoxy bulb)							°C

LED NUMERIC DISPLAY, 1 DIGIT

BL-S100X-12XX

■ Package configuration & Internal circuit diagram

BL-S100X-12 Series

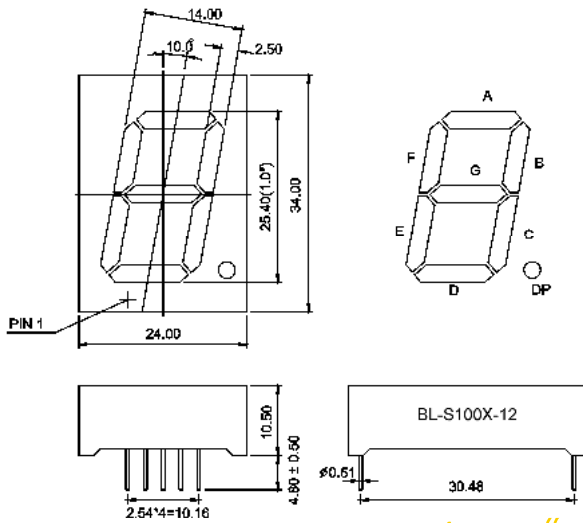

BL-S100A-12xx

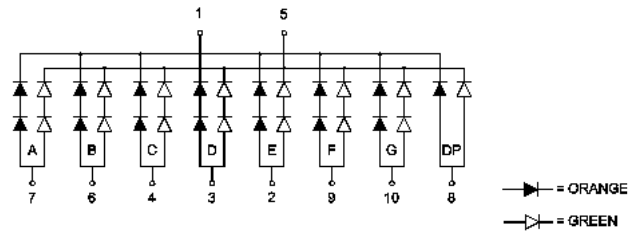

BL-S100B-12xx

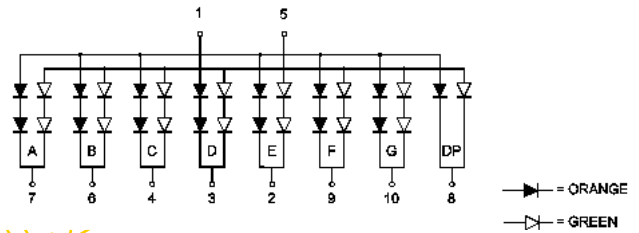

Notes:

1. All dimensions are in millimeters (inches)
2. Tolerance is $\pm 0.25(0.01)$ unless otherwise noted.
3. Specifications are subject to change without notice.

LED NUMERIC DISPLAY, 1 DIGIT

BL-S100X-12XX

Typical electrical-optical characteristics curves:



- | | |
|---|--------------------------------------|
| (1) - GaAsP/GaAs 655nm/Red | (9) - GaAlAs 880nm |
| (2) - GaP 570nm/Yellow Green | (10) - GaAs/GaAs & GaAlAs/GaAs 940nm |
| (3) - GaAsP/GaP 585nm/Yellow | (A) - GaN/SiC 430nm/Blue |
| (4) - GaAsP/GaP 635nm/Orange & Hi-Eff Red | (B) - InGaN/SiC 470nm/Blue |
| (5) - GaP 700nm/Bright Red | (C) - InGaN/SiC 505nm/Ultra Green |
| (6) - GaAlAs/GaAs 660nm/Super Red | (D) - InGaN/SiC 525nm/Ultra Green |
| (8) - GaAsP/GaP 610nm/Super Red | |

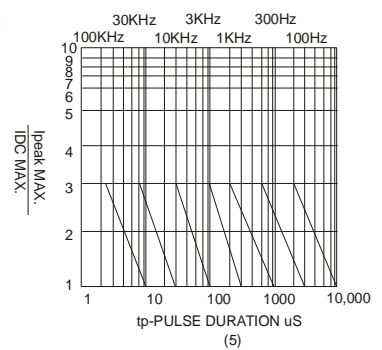
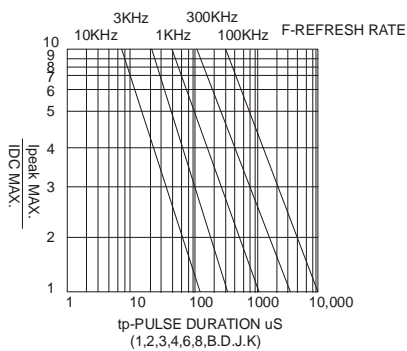
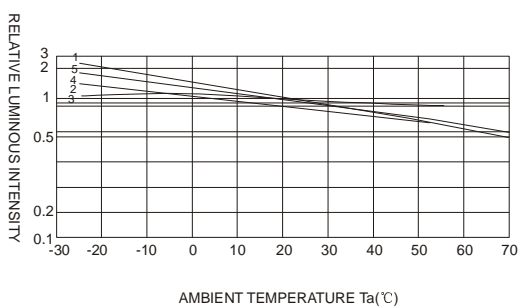
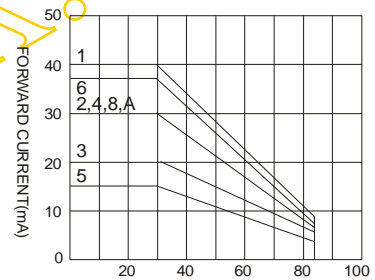
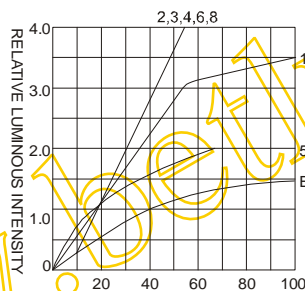

NOTE:25°C free air temperature unless otherwise specified