

Intelligent Flag I/II V600-HA

Innovative RFID Electronic Flags to Replace Mechanical Flag and Kanban Systems

- Doesn't need a program and can be used like a sensor.
- Advanced line construction at minimal cost.
- Saves space.
- Precise installation not required (Transmission distance: 100 mm max.).
- A verification function provided on multi-functional type.
- Addition of 16-bit models to the series responds to applications from Kanban to quality control.
- Equipped with a wiring reduction mode and communications parity check function (16-bit models).
- Both NPN and PNP output available.
- FCC certified.



Ordering Information/Specifications

■ Amplifier

Item	Type Model	Read-only (8-bit)		Multi-functional (8-bit)		Read-only (16-bit)
		V600-HAR91	V600-HAR81	V600-HAM91	V600-HAM81	V600-HAR92
Power supply	24 VDC ±10%, ripple (p-p): 10%					
Current consumption	130 mA max.					
Input	Transistor output or contact output Short-circuit current: 3 mA (typical) (IN terminal and 0-V short-circuit) OFF voltage: 15 to 30 VDC ON voltage: 0 to 5 VDC Input impedance: 8.2 kΩ Applied voltage: 30 VDC max.					Transistor output OFF voltage: 15 to 30 VDC Input impedance: 8.2 kΩ Short-circuit current: 3 mA (typical) (for 0-V short-circuit of INHIBIT/TRG) ON voltage: 0 to 5 VDC Applied voltage: 30 VDC max.
Output	NPN open collector output, 20 mA max. at 30 VDC, residual voltage: 2 V max.	PNP open collector output, 20 mA max. at 30 VDC, residual voltage: 2 V max.	NPN open collector output, 20 mA max. at 30 VDC, residual voltage: 2 V max.	PNP open collector output, 20 mA max. at 30 VDC, residual voltage: 2 V max.	NPN open collector output, 20 mA max. at 30 VDC, residual voltage: 2 V max.	
Diagnostic functions	Checks for CPU errors and transmission errors					
Insulation resistance	50 MΩ max. (at 500 VDC) between cable terminals and case					
Dielectric strength	500 VAC, 50/60 Hz for 1 min between cable terminals and case (leakage current: 1 mA max.)					

Item	Type Model	Read-only (8-bit)		Multi-functional (8-bit)		Read-only (16-bit)
		V600-HAR91	V600-HAR81	V600-HAM91	V600-HAM81	V600-HAR92
Vibration resistance		Destruction: 10 to 150 Hz, 0.3-mm double amplitude, with 4 sweeps of 8 min each in 3 directions				Destruction: 10 to 150 Hz, 1.5-mm double amplitude, with 4 sweeps of 8 min each in 3 directions
Shock resistance		Destruction: 294 m/s ² , 3 times each in 6 directions				
Ambient temperature		-10 to 55°C (with no icing)				
Ambient humidity		35% to 85% (with no condensation)				
Storage temperature		-25 to 65°C				
Degree of protection		IEC60529: IP40				
Ground		Ground to 100 Ω or less.				
Material		ABS resin (case)				
Cable length		Standard, 0.5 m with a dedicated connector (See note.)				
Weight		Approx. 170 g				Approx. 180 g

Note: The connector is not waterproof. If there is a possibility that the connector may be exposed to water, keep it inside the control box. Be sure to use the connector together with the separately sold interface cable.

■ Functions

V600-HAR91/-HAR81 (Read-only type)

Reads the 8-bit data (1 byte) of the set address and outputs to the 8 data output lines.

V600-HAM91/-HAM81 (Multi-functional type)

The amplifier has the following three basic functions.

Read

Reads the 8-bit (1 byte) data of the set address and outputs to the 8 data output lines.

Write

Writes on the set address the 8-bit (1 byte) data designated via the 8 data input lines.

Verify

Reads the 8-bit data (1 byte) of the set address, compares with the 8-bit (1 byte) data input via the 8 verification data input lines, and outputs the verification result.

V600-HAR92 (Read-only type)



Reads the 16-bit data (2 bytes) of the set address and outputs to the 16 data output lines.

■ Interface Cable

Amplifier	Cable length	Interface Cable
V600-HAR91/81 (Connector: 20 pin)	2 m	V600-A60R
	5 m	V600-A61R
	10 m	V600-A62R
V600-HAM91/81 V600-HAR92 (Connector: 26 pin)	2 m	V600-A60M
	5 m	V600-A61M
	10 m	V600-A62M

Note: The interface cable connector is not waterproof. If there is a possibility that the connector may be exposed to water, keep it inside the control box. The maximum cable length is 10 m.

■ Sensor

Item	Model Shape	V600-HS51	V600-HS61	V600-HS63	V600-HS67
					
Transmission frequency	530 kHz				
Ambient temperature	-10 to 60°C			-10 to 70°C	
Storage temperature	-25 to 75°C				
Ambient humidity	35% to 95%				
Insulation resistance	50 MΩ (at 500 VDC) between cable terminal and case				
Dielectric strength	1,000 VAC, 50/60 Hz for 1 min between cable terminal and case (leakage current: 1 mA max.)				
Degree of protection	IEC60529: IP67				
Vibration resistance	Destruction: 10 to 2,000 Hz, 3-mm double amplitude, with 2 sweeps of 15 min each in 3 directions			Destruction: 10 to 500 Hz, 2-mm double amplitude, with 3 sweeps of 11 min each in 3 directions	
Shock resistance	Destruction: 981 m/s ² , 3 times each in 3 directions (18 times total)			Destruction: 490 m/s ² , 3 times each in 3 directions (18 times total)	
Cable length	2 m (fixed)				
Wireless transmission error direction	16-bit CRC (Cyclic Redundancy Check) in both directions				
Indicator	---			Power: green	
Weight	Approx. 70 g			Approx. 190 g	Approx. 540 g

■ Transmission Distance Specifications

Recommended Combinations

Data Carrier	Amplifier Sensor	V600-HAR91/-HAR81/-HAM91/-HAM81/-HAR92			
		V600-HS51	V600-HS61	V600-HS63	V600-HS67
Memory EEPROM (Battery-less type)	V600-D23P53	0.5 to 3.0 mm	0.5 to 3.0 mm	---	---
	V600-D23P54	0.5 to 5.0 mm	0.5 to 5.5 mm	---	---
	V600-D23P55	0.5 to 7.0 mm	0.5 to 7.0 mm	0.5 to 9.5 mm	---
	V600-D23P61	0.5 to 8.0 mm	0.5 to 9.0 mm	2 to 16 mm	---
	V600-D23P66N	---	---	5 to 30 mm	5 to 35 mm
	V600-D23P66SP	---	---	5 to 25 mm	5 to 30 mm
	V600-D23P71	---	---	5 to 35 mm	10 to 70 mm
	V600-D23P72	---	0.5 to 18 mm	5 to 35 mm	10 to 50 mm
Memory SRAM (Built-in-battery type)	V600-D8KR12	5 to 15 mm	5 to 18 mm	5 to 45 mm	10 to 60 mm
	V600-D8KR13	---	---	10 to 30 mm	10 to 40 mm
	V600-D8KR04	---	---	10 to 65 mm	10 to 100 mm
	V600-D2KR16	---	---	2 to 15 mm	---

Note: 1. The specifications take fluctuations in ambient temperature and slight differences between products into account.

2. The read distance and write distance are the same.

3. Sensor Installation Conditions

• V600-HS51: When flush-mounted in iron

Axial offset from the Data Carrier: ±2.0 mm

- V600-HS61: When surface-mounted on metal (ferrous)
Axial offset from the Data Carrier: ±2.0 mm
- V600-HS63: When surface-mounted on metal (ferrous)
Axial offset from the Data Carrier: ±10.0 mm
- V600-HS67: When surface-mounted on metal (ferrous)
Axial offset from the Data Carrier: ±10.0 mm

4. Data Carrier Installation Conditions

- V600-D23P53/-P54: When flush-mounted in iron
- V600-D23P55/-P66N/-P66SP/-P71/-P72: When surface-mounted on resin (no metal on the backside)
- V600-D23P61: When surface-mounted on metal (ferrous)
- V600-D8KR12/-13/-04: When surface-mounted on metal (ferrous)
- V600-D2KR16: When the Data Carrier attached to the holder is mounted on a metal (ferrous) surface

5. The transmission distance specified in the specifications is also applicable when the Data Carrier is mounted on non-metallic surfaces.

6. The Data Carrier is stationary.

System Configuration

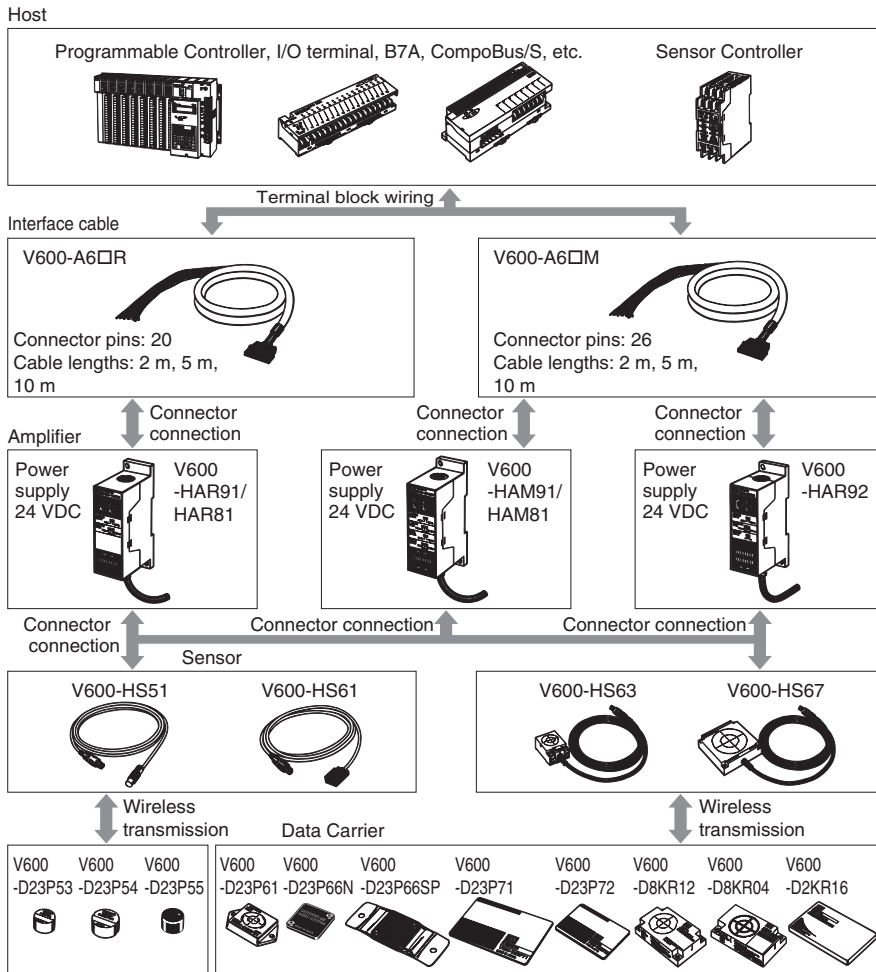
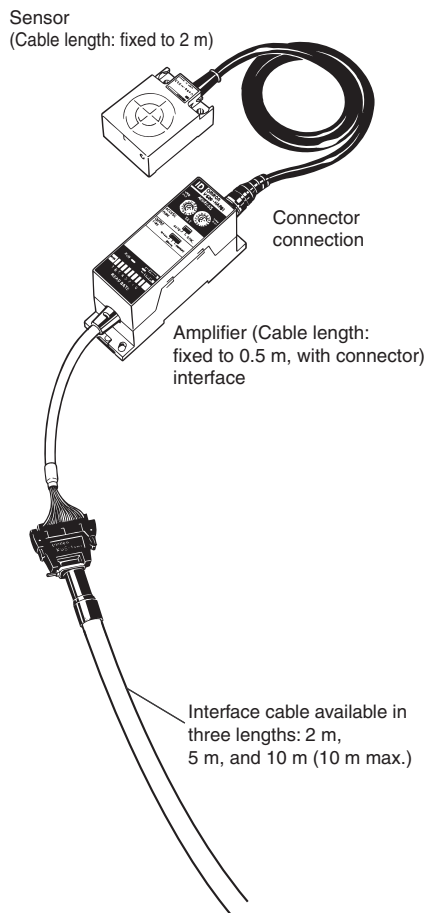

Characteristic Data (Typical)

■ Transmission Range

Combinations with the V600-HS51 Sensor

V600-HS51 & V600-D23P53

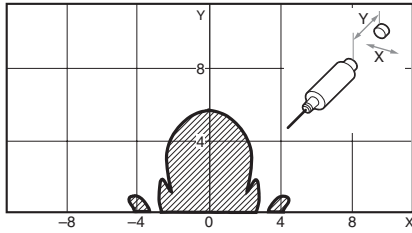

V600-HS51 & V600-D23P54

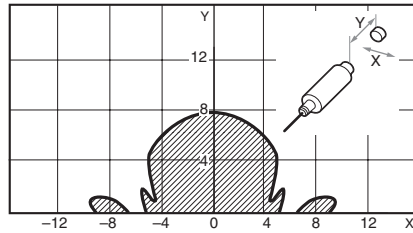

V600-HS51 & V600-D23P55

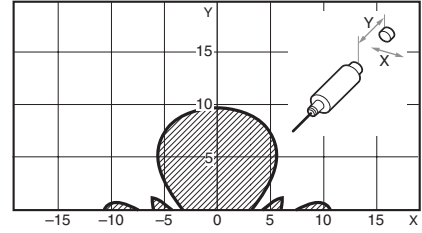

V600-HS51 & V600-D23P61

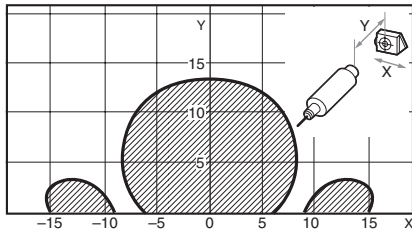

V600-HS51 & V600-D23P66N

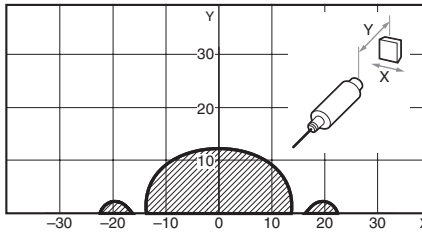

V600-HS51 & V600-D8KR12

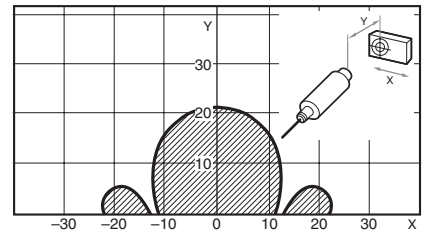

Combinations with the V600-HS61 Sensor

V600-HS61 & V600-D23P53

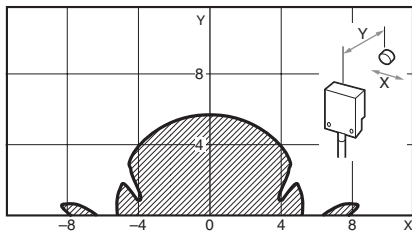

V600-HS61 & V600-D23P54

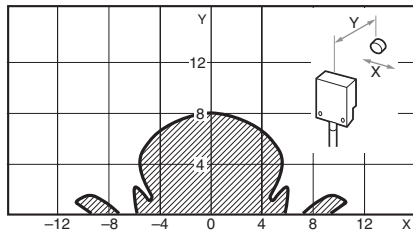

V600-HS61 & V600-D23P55

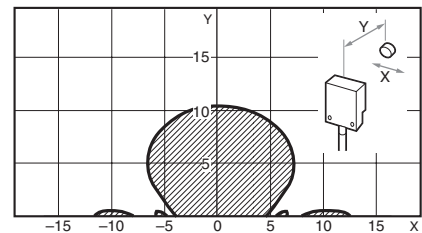

V600-HS61 & V600-D23P61

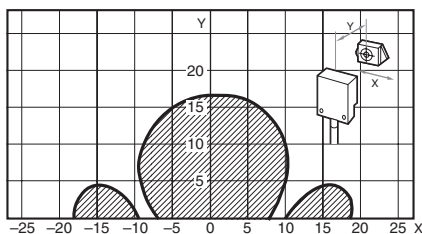

V600-HS61 & V600-D23P72

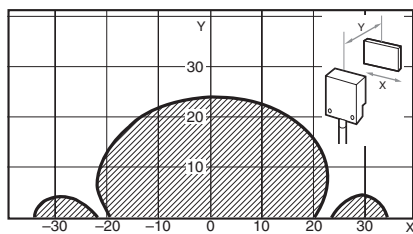

V600-HS61 & V600-D8KR12

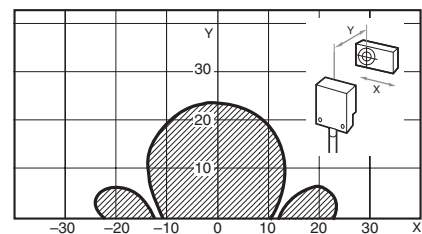

Combinations with the V600-HS63 Sensor

V600-HS63 & V600-D23P55

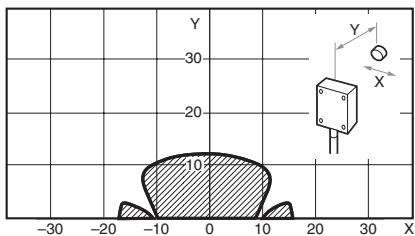

V600-HS63 & V600-D23P61

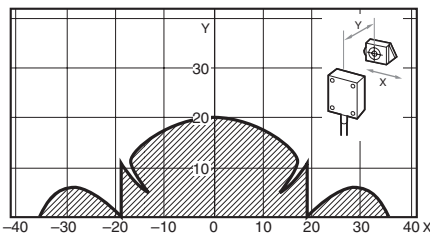

V600-HS63 & V600-D23P66N

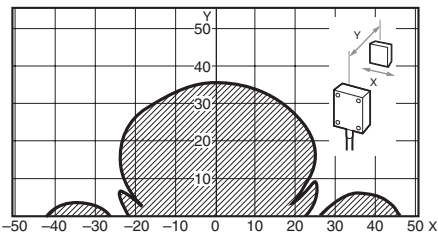

V600-HS63 & V600-D23P66SP

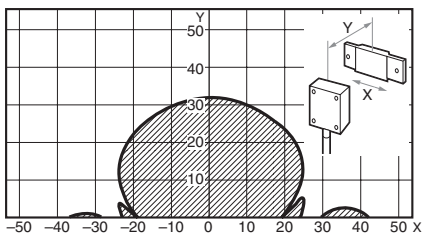

V600-HS63 & V600-D23P71

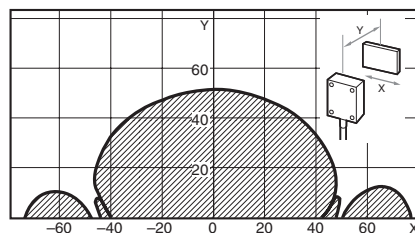

V600-HS63 & V600-D23P72

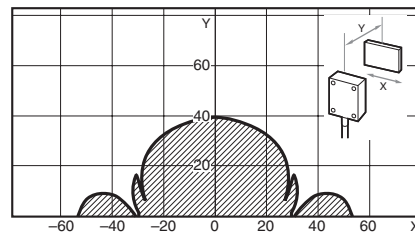

V600-HS63 & V600-D8KR12

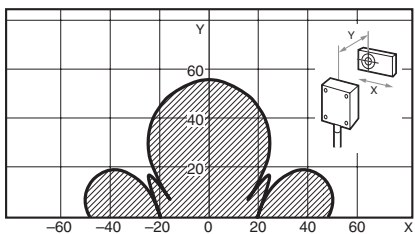

V600-HS63 & V600-D8KR04

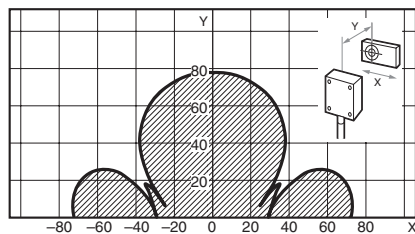

V600-HS63 & V600-D2KR16

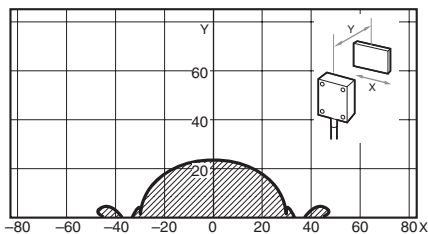

Combinations with the V600-HS67 Sensor

V600-HS67 & V600-D23P66N

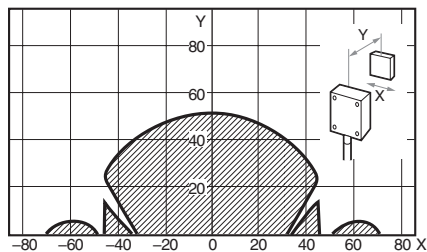

V600-HS67 & V600-D23P66SP

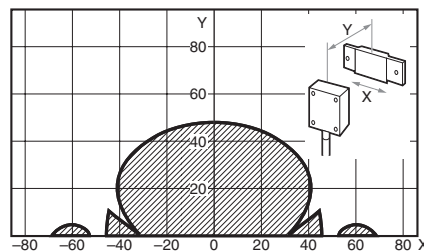

V600-HS67 & V600-D23P71

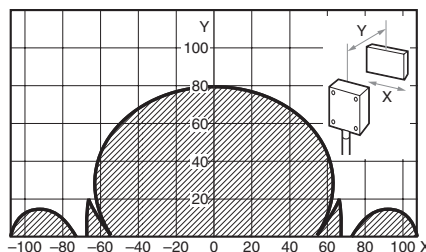

V600-HS67 & V600-D23P72

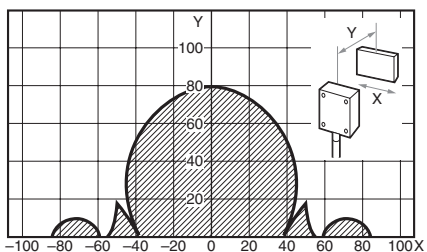

V600-HS67 & V600-D8KR12

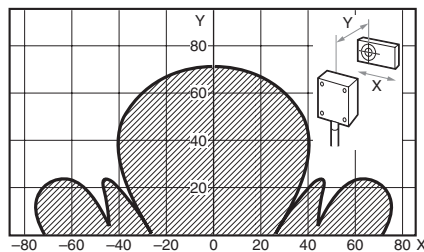

V600-HS67 & V600-D8KR13

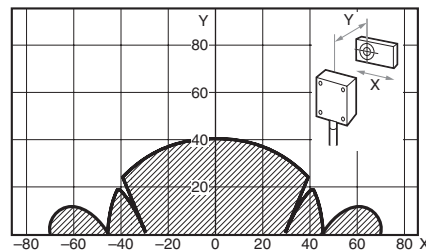

V600-HS67 & V600-D8KR04

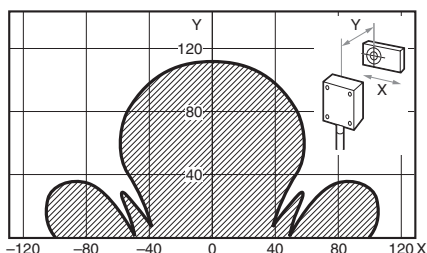

Transmission Time

The transmission time refers to the time required for communications between the Sensor and the Data Carrier. It is used for calculating the travel speed of the auto command.

$$\text{DC speed (conveyor speed)} = \frac{\text{Distance travelled in the transmission range}}{\text{Transmission time}}$$

Model		V600-HAR91/-HAR81/-HAM91/-HAM81			V600-HAR92
		Read	Write		Read
Mode type		DATA READ mode, VERIFY READ mode	BYTE mode	BIT SET mode, BIT CLEAR mode	DATA READ mode
Data Carrier type	EEPROM	75 ms	138 ms	150 ms	77 ms
	SRAM	60 ms	95 ms	107 ms	62 ms

Example: Combinations with the V600-HAR91, V600-HS63, and V600-D8KR04 Sensors.

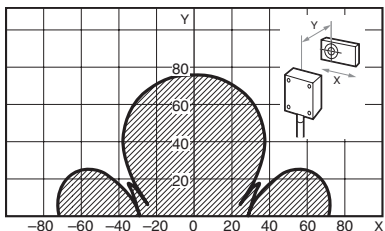

$$\text{DC speed (conveyor speed)} = \frac{75 \text{ (mm)}}{60 \text{ (ms)}} = \frac{75 \times 10^{-3} \text{ (m)}}{60 \times 10^{-3} \times 1/60 \text{ (min)}} = 75 \text{ (m/min)}$$

- Note:**
1. The DC speed varies depending on transmission distance Y and the axial offset. It is recommended that you refer to the transmission range graphs and use the product where the range is the largest.
 2. This calculation is intended as a guideline only. Perform a test with the actual product prior to use.
 3. This equation does not include transmission error processing.

Circuit Configuration

V600-HAR91 V600-HAM91

Input Circuit

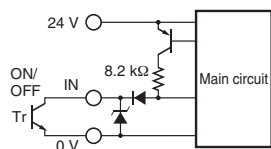

Output Circuit

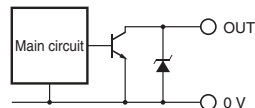

V600-HAR92

Input Circuit

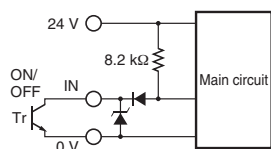

Output Circuit

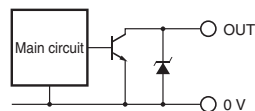

V600-HAR81 V600-HAM81

Input Circuit

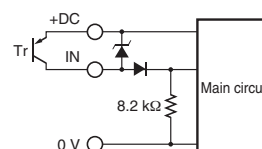

Output Circuit

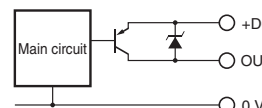

Precautions

■ Cautions

⚠ Caution

Be sure to house the V600-HA□91/-HA□81/-HA□92 together with their connectors and cable in control boxes when using them and do not expose them to water, oil, dust, metal powder, corrosive gas, or organic solvent, otherwise they may malfunction, suffer damage, or burn.

⚠ Caution

The connectors of the V600-HA□91/-HA□81/-HA□92 can be mounted to metal plates, provided that there is an insulation plate with a thickness of 1.5 mm minimum between each of the connectors and metal plates.

Input/Output

The Data Input and Data Output lines are set to "1" when the transistor turns ON and to "0" when it turns OFF.

Do not use a solid-state output with the following ratings with the V600-HAM91/-HAM81, otherwise an external input error may result.

1. Maximum switching current: 1 A min.
2. Minimum switching current: 10 mA min.
3. Response time (ON to OFF): 3 ms min.

The following OMRON products cannot be connected to this product.

- CVM1-OD219, C20H, C28H, C40H, or C60H Programmable Controllers
- Sensor Controllers other than from the S3D2 Series

When using a contact output, pay careful attention to chattering and to the minimum switching current. Also note that the minimum switching current may be specified for some solid-state outputs.

When connecting an inductive load or an electrical device that tends to generate noise to the output, connect a diode in parallel with the load. Connect the cathode side of the diode to the positive side of the power source.

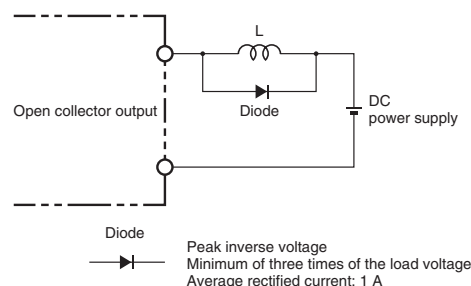

Power Supply Voltage

Do not impose any voltage exceeding the rated voltage range. Doing so, or applying alternating current (100 VAC) may cause the product to explode or burn.

Load Short-circuiting

Do not short-circuit the load connected to the product or connect to the power supply. Doing so may cause the product to explode or burn.

Wiring

Avoid wiring mistakes such as incorrect polarity in the power supply. Wiring mistakes may cause the product to explode or burn.

Correct Use

Grounding

The FG line is provided for grounding to the earth. When using the Amplifier in an environment where it is exposed to large amounts of noise or if the V600-HA□91/HA□81/HA□92 Amplifier malfunctions, provide a Class-3 ground (ground resistance of 100 Ω or less). Note that sharing the grounding wire with other equipment or grounding to the beam of a building will adversely affect the grounding effect.

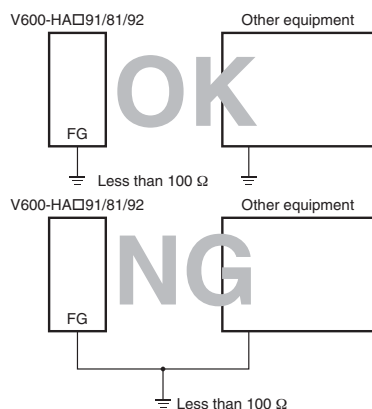

Mounting

Amplifier Spacing

When installing V600-HA□91/V600-HA□81/V600-HA□92 Amplifiers in a row, provide a minimum space of 10 mm between Amplifiers in order to prevent them from being affected by the heat produced by each Amplifier.

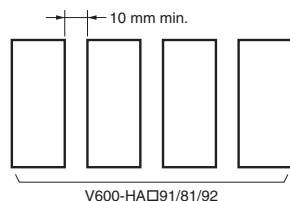

When housing the Amplifiers in a box, provide a fan or ventilation opening for radiating the heat.

When wiring power cables, which carry large current such as motor drive cables, near the V600-HA□91/81/92 Amplifiers, conduct necessary tests to make sure that the installation conditions are fully satisfied.

I/O Interface Requirements

1. The TRG input must be 10 ms min.
2. The INHIBIT input must be 20 ms min.
3. Minimum of 5 ms is required as the transfer time of the Read/Write Selection Input (W/R).
4. The read data output must be read after the Normal End Output is set to ON.

Connecting the Sensor

Hold the black part of the connector, line up the notch and push it in until it clicks.

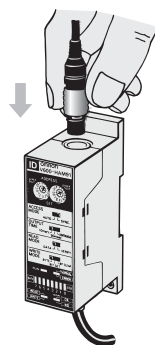

Compatibility with the SRAM Memory Type Data Carrier

1. If the Data Carrier is stationary in the transmission area for a long time when using the V600-HA□91/81 in the AUTO mode, or when using the V600-HAR92, it will drastically reduce the battery life. Therefore, stop the oscillation in the sensor either by turning off the power of the V600-HA□91/81/92 Amplifier or by setting the Inhibit input to ON.
2. Use a Data Carrier that has the oscillation frequency of 530 kHz. Note that the following models manufactured before February 1991 cannot be used.
 - V600-D2KR01
 - V600-D2KR02

Precautions When Using the AUTO Mode

If transmitting to the Data Carrier while it is traveling under the AUTO mode, conduct tests to make sure that the travel speed and installation conditions are fully satisfied.

Dimensions

Note: All units are in millimeters unless otherwise indicated.

Amplifier

V600-HAR91/-HAR81

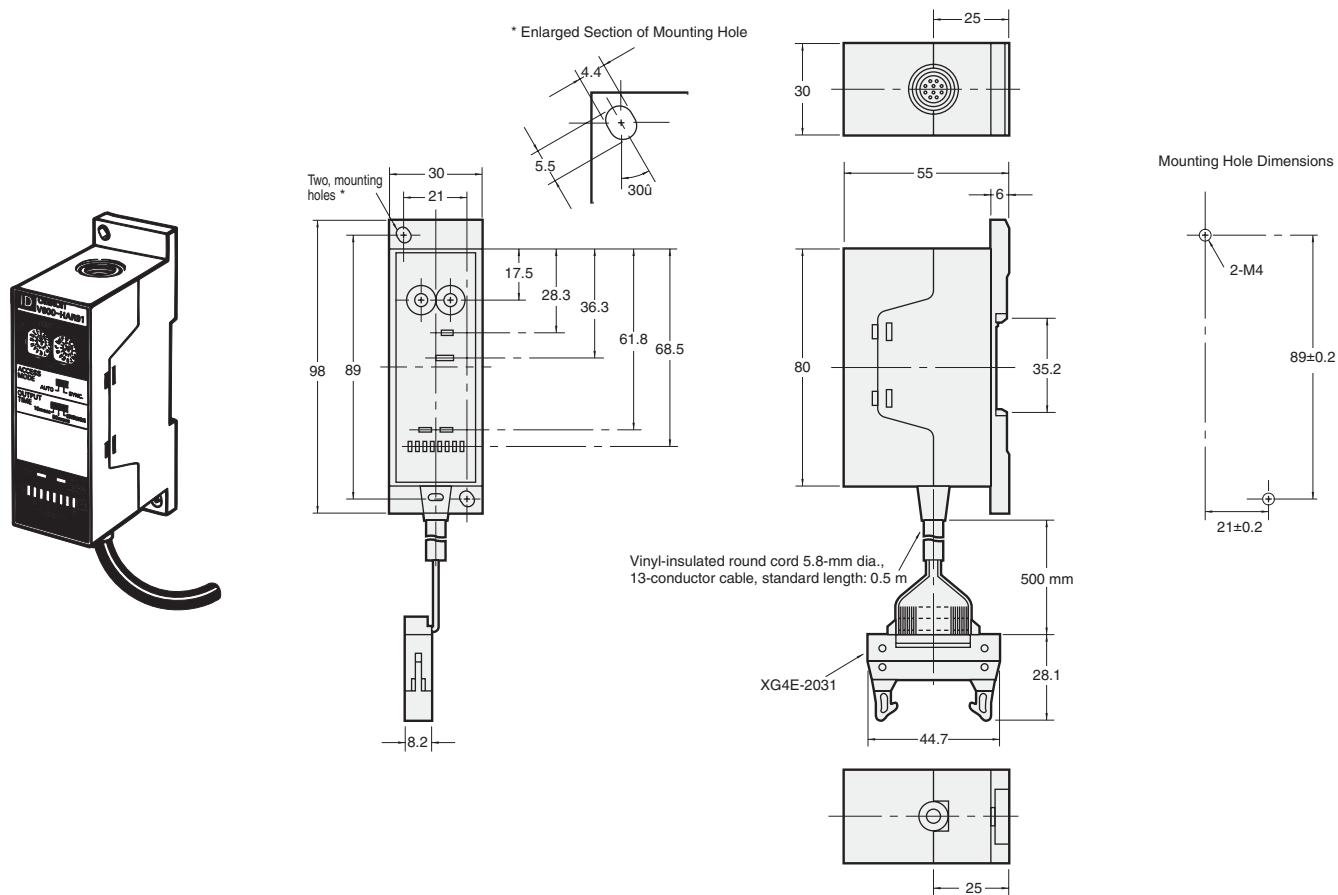

V600-HAM91/-HAM81

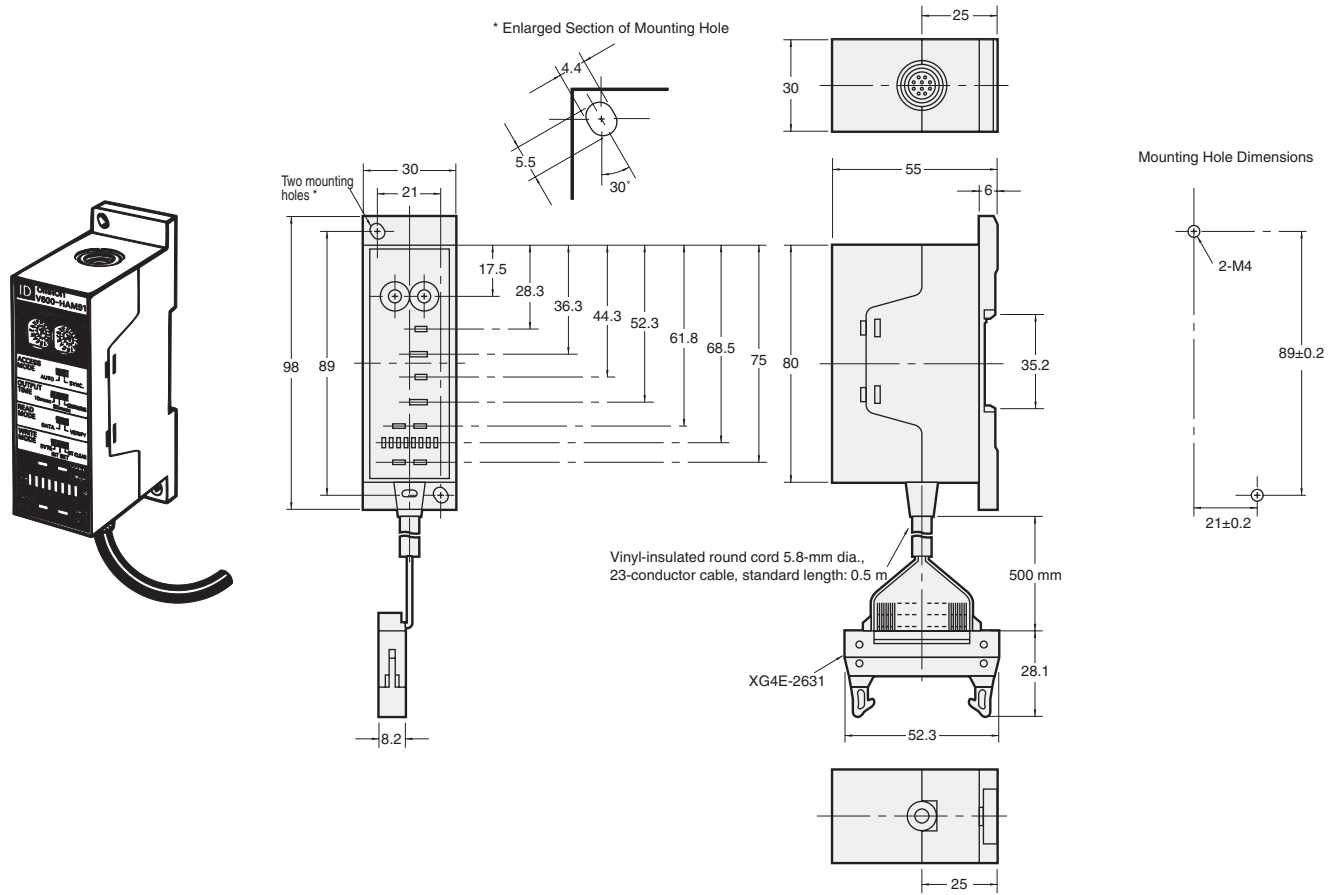

V600-HAR92

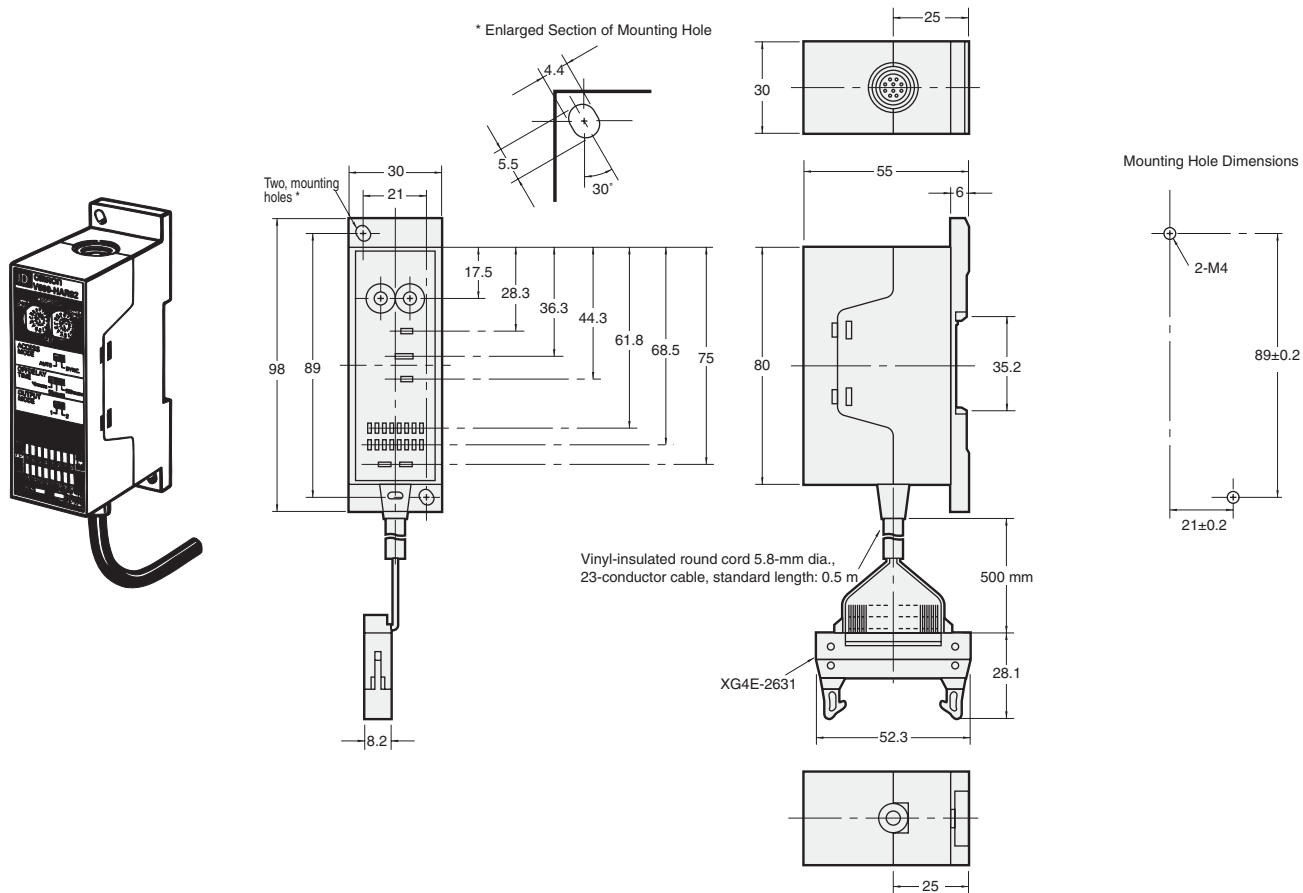

Sensor

V600-HS51

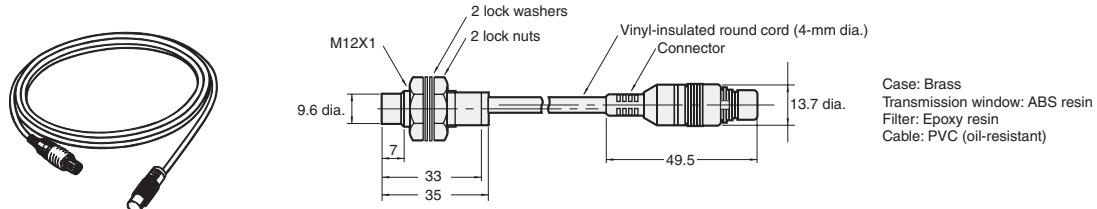

V600-HS61

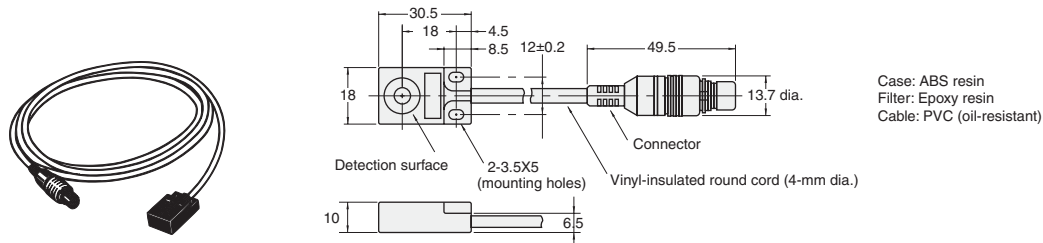

V600-HS63

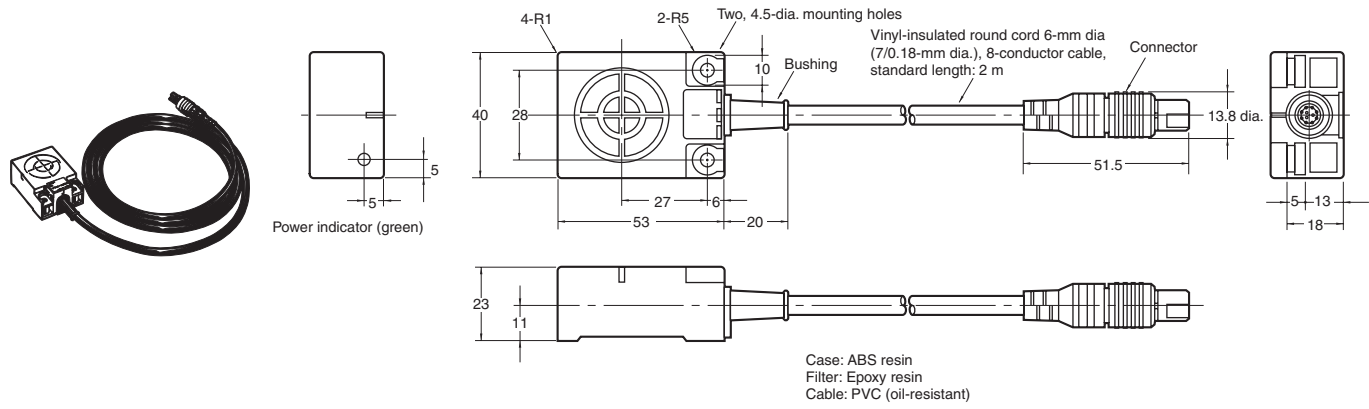

V600-HS67

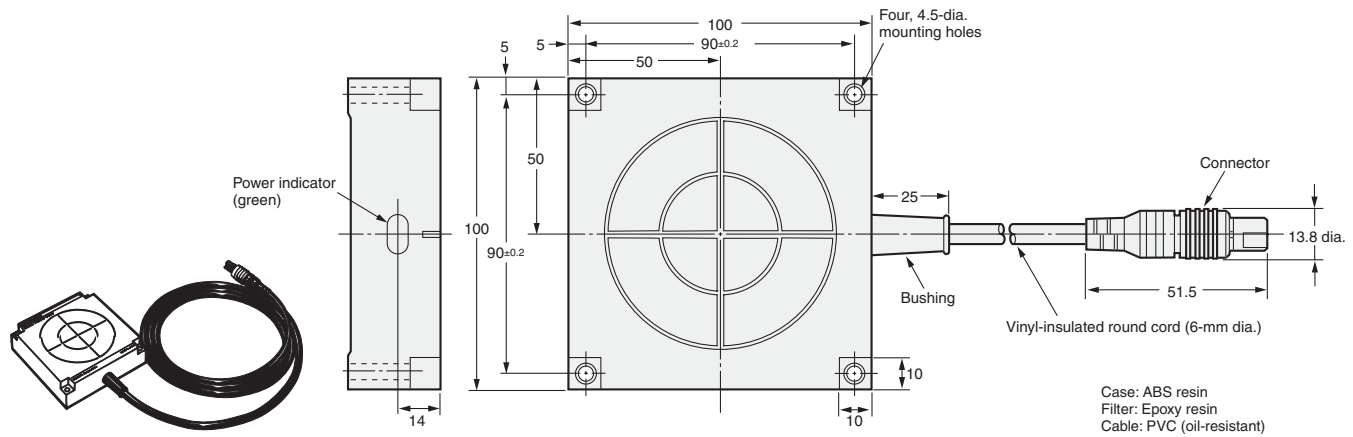

Interface Cable

V600-A6□R (for V600-HAR91/-HAR81))

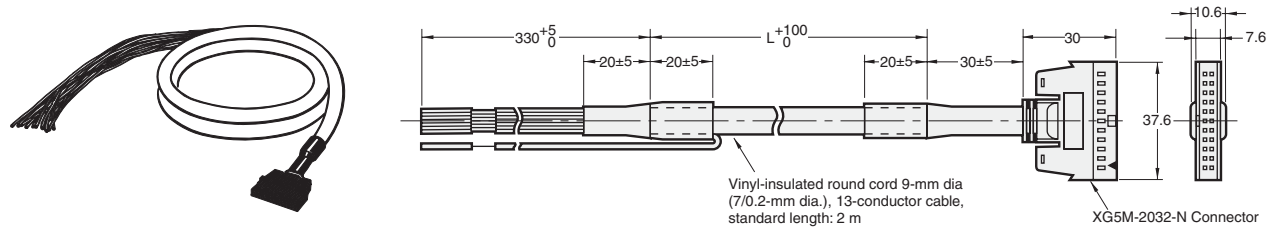

V600-A6□M (for V600-HAM91/-HAM81/-HAR92)

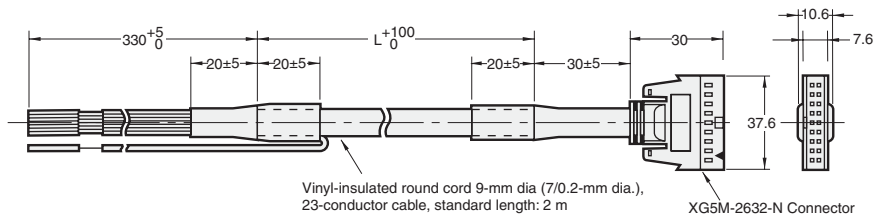
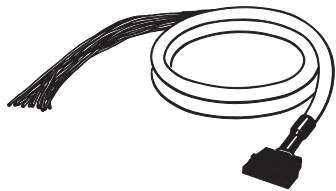

Model	L (m)
V600-A60R/60M	2
V600-A61R/61M	5
V600-A62R/62M	10

Terms and Conditions

WARRANTY, LIMITATIONS OF LIABILITY

WARRANTY OMRON's exclusive warranty is that the products are free from defects in materials and workmanship for a period of one year (or other period if specified) from date of sale by OMRON.

OMRON MAKES NO WARRANTY OR REPRESENTATION, EXPRESS OR IMPLIED, REGARDING NON-INFRINGEMENT, MERCHANTABILITY OR FITNESS FOR PARTICULAR PURPOSE OF THE PRODUCTS. ANY BUYER OR USER ACKNOWLEDGES THAT IT ALONE HAS DETERMINED THAT THE PRODUCTS WILL SUITABLY MEET THE REQUIREMENTS OF THEIR INTENDED USE. OMRON DISCLAIMS ALL OTHER WARRANTIES, EXPRESS OR IMPLIED.

LIMITATIONS OF LIABILITY OMRON SHALL NOT BE RESPONSIBLE FOR SPECIAL, INDIRECT OR CONSEQUENTIAL DAMAGES, LOSS OF PROFITS OR COMMERCIAL LOSS IN ANY WAY CONNECTED WITH THE PRODUCTS, WHETHER SUCH CLAIM IS BASED ON CONTRACT, WARRANTY, NEGLIGENCE OR STRICT LIABILITY.

In no event shall responsibility of OMRON for any act exceed the individual price of the product on which liability is asserted.

IN NO EVENT SHALL OMRON BE RESPONSIBLE FOR WARRANTY, REPAIR OR OTHER CLAIMS REGARDING THE PRODUCTS UNLESS OMRON'S ANALYSIS CONFIRMS THAT THE PRODUCTS WERE PROPERLY HANDLED, STORED, INSTALLED AND MAINTAINED AND NOT SUBJECT TO CONTAMINATION, ABUSE, MISUSE, OR INAPPROPRIATE MODIFICATION OR REPAIR.

APPLICATION CONSIDERATIONS

SUITABILITY FOR USE OMRON shall not be responsible for conformity with any standards, codes or regulations which apply to the combination of the product in the customer's application or use of the product.

At the customer's request, OMRON will provide applicable third party certification documents identifying ratings and limitations of use which apply to the product. This information by itself is not sufficient for a complete determination of the suitability of the product in combination with the end product, machine, system, or other application or use.

The following are some examples of applications for which particular attention must be given. This is not intended to be an exhaustive list

of all possible uses of this product, nor is it intended to imply that the uses listed may be suitable for this product:

- Outdoor use, uses involving potential chemical contamination or electrical interference, or conditions or uses not described in this catalog.
- Nuclear energy control systems, combustion systems, railroad systems, aviation systems, medical equipment, amusement machines, vehicles, safety equipment, and installations subject to separate industry or government regulations.
- Systems, machines and equipment that could present a risk to life or property.

Please know and observe all prohibitions of use applicable to this product.

NEVER USE THE PRODUCT FOR AN APPLICATION INVOLVING SERIOUS RISK TO LIFE OR PROPERTY WITHOUT ENSURING THAT THE SYSTEM AS A WHOLE HAS BEEN DESIGNED TO ADDRESS THE RISKS, AND THAT THE OMRON PRODUCT IS PROPERLY RATED AND INSTALLED FOR THE INTENDED USE WITHIN THE OVERALL EQUIPMENT OR SYSTEM.

PROGRAMMABLE PRODUCTS OMRON shall not be responsible for the user's programming of a programmable product, or any consequence thereof.

DISCLAIMERS

PERFORMANCE DATA Performance data given in this catalog is provided as a guide for the user in determining suitability and does not constitute a warranty. It may represent the result of OMRON's test conditions, and the user must correlate it to actual application requirements. Actual performance is subject to the OMRON Warranty and Limitations of Liability.

CHANGE IN SPECIFICATIONS Product specifications and accessories may be changed at any time based on improvements and other reasons. It is our practice to change part numbers when published ratings or features are changed, or when significant construction changes are made. However, some specifications of the product may be changed without any notice. When in doubt, special part numbers may be assigned to fix or establish key specifications for your application. Please consult with your OMRON representative at any time to confirm actual specifications of purchased product.

ERRORS AND OMISSIONS The information in this catalog has been carefully checked and is believed to be accurate; however, no responsibility is assumed for clerical, typographical or proofreading errors, or omissions.

Complete terms and conditions for product purchase and use are on Omron's website at www.omron.com/oei – under the "About Us" tab, in the Legal Matters section.

ALL DIMENSIONS SHOWN ARE IN MILLIMETERS. To convert millimeters into inches, divide by 25.4

OMRON®

OMRON ELECTRONICS LLC

One Commerce Drive
Schaumburg, IL 60173

847-843-7900

For US technical support or other inquiries:

800-556-6766

OMRON CANADA, INC.

885 Milner Avenue
Toronto, Ontario M1B 5V8

416-286-6465

OMRON ON-LINE

Global - <http://www.omron.com>
USA - <http://www.omron.com/oei>
Canada - <http://www.omron.ca>