

T1G6003028-FS

30W, 28V, DC – 6 GHz, GaN RF Power Transistor

Applications

- Military radar
- Civilian radar
- Professional and military radio communications
- Test instrumentation
- Wideband or narrowband amplifiers
- Jammers



Product Features

- Frequency: DC to 6 GHz
- Output Power (P_{3dB}): 30 W at 6 GHz
- Linear Gain: >14 dB at 6 GHz
- Operating Voltage: 28 V
- Low thermal resistance package

Functional Block Diagram

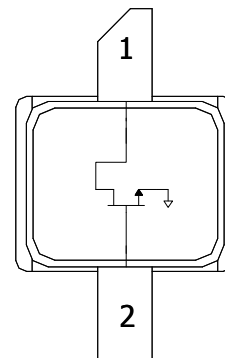

General Description

The TriQuint T1G6003028-FS is a 30 W (P_{3dB}) discrete GaN on SiC HEMT which operates from DC to 6 GHz. The device is constructed with TriQuint's proven 0.25 μ m process, which features advanced field plate techniques to optimize power and efficiency at high drain bias operating conditions. This optimization can potentially lower system costs in terms of fewer amplifier line-ups and lower thermal management costs.

Lead-free and RoHS compliant

Evaluation Boards are available upon request.

Pin Configuration

Pin #	Symbol
1	Vd/RF OUT
2	Vg/RF IN
Flange	Source

Ordering Information

Material No.	Part No.	Description	ECCN
1080206	T1G6003028-FS	Packaged part: Flangeless	EAR99
1093989	T1G6003028-FS- EVB1	5.4-5.9 GHz Eval. Board	EAR99

T1G6003028-FS

30W, 28V, DC – 6 GHz, GaN RF Power Transistor



Specifications

Absolute Maximum Ratings

Parameter	Rating
Drain to Gate Voltage, Vd – Vg	40 V
Drain Voltage, Vd	+40 V
Gate Voltage, Vg	-8 to 0 V
Drain Current, Id	5.5 A
Gate Current, Ig	-10 to 10 mA
Power Dissipation, P _{diss}	47.5 W
RF Input Power, CW, T = 25°C	40 dBm
Channel Temperature, T _{ch}	275 °C
Mounting Temperature (30 sec)	320 °C
Storage Temperature	-40 to 150 °C

Operation of this device outside the parameter ranges given above may cause permanent damage. These are stress ratings only, and functional operation of the device at these conditions is not implied.

Recommended Operating Conditions

Parameter	Min	Typical	Max	Units
Vd		28		V
Idq		200		mA
Id (Peak Current)		2500		mA
Vg		-3.6		V
Channel Temperature, T _{ch}		205		°C
Power Dissipation, P _{diss} (CW)			30	W
Power Dissipation, P _{diss} (Pulse)			40	W

Electrical specifications are measured at specified test conditions. Specifications are not guaranteed over all recommended operating conditions.

Electrical Specifications

Recommended operating conditions apply unless otherwise specified: T_A = 25 °C, Vd = 28 V, Idq = 200 mA, Vg = -3.6 V

RF Characteristics

Characteristics	Symbol	Min	Typ	Max	Units
Load Pull Performance at 3.0 GHz (V_{DS} = 28 V, I_{DQ} = 200 mA; Pulse: 100µs, 20%)					
Linear Gain	G _{LIN}		15.2		dB
Output Power at 3 dB Gain Compression	P _{3dB}		33.5		W
Drain Efficiency at 3 dB Gain Compression	DE _{3dB}		68.2		%
Power-Added Efficiency at 3 dB Gain Compression	PAE _{3dB}		64.1		%
Gain at 3 dB Compression	G _{3dB}		12.2		dB
Load Pull Performance at 6.0 GHz (V_{DS} = 28 V, I_{DQ} = 200 mA; Pulse: 100µs, 20%)					
Linear Gain	G _{LIN}		14.5		dB
Output Power at 3 dB Gain Compression	P _{3dB}		33.0		W
Drain Efficiency at 3 dB Gain Compression	DE _{3dB}		50.0		%
Power-Added Efficiency at 3 dB Gain Compression	PAE _{3dB}		46.5		%
Gain at 3 dB Compression	G _{3dB}		11.5		dB
Performance at 5.60 GHz in the 5.4 to 5.9 GHz Eval. Board (V_{DS} = 28 V, I_{DQ} = 200 mA; Pulse: 100µs, 20%)					
Linear Gain	G _{LIN}	12.0	14.0		dB
Output Power at 3 dB Gain Compression	P _{3dB}	22.5	32.5		W
Drain Efficiency at 3 dB Gain Compression	DE _{3dB}	45.0	50.0		%
Gain at 3 dB Compression	G _{3dB}	9.0	11.0		dB
Narrow Band Performance at 5.60 GHz (V_{DS} = 28 V, I_{DQ} = 200 mA, CW at P1dB)					
Impedance Mismatch Ruggedness	VSWR			10:1	

Note: VSWR testing performed with increasing real impedance value only from reference Z to 10 times reference Z.

T1G6003028-FS

30W, 28V, DC – 6 GHz, GaN RF Power Transistor



Specifications (cont.)

Thermal and Reliability Information

Test Conditions	T _{CH} (°C)	Θ _{JC} (°C/W)
DC at 85 °C	205	4.0

Note: Thermal resistance, Θ_{JC}, measured to bottom of package

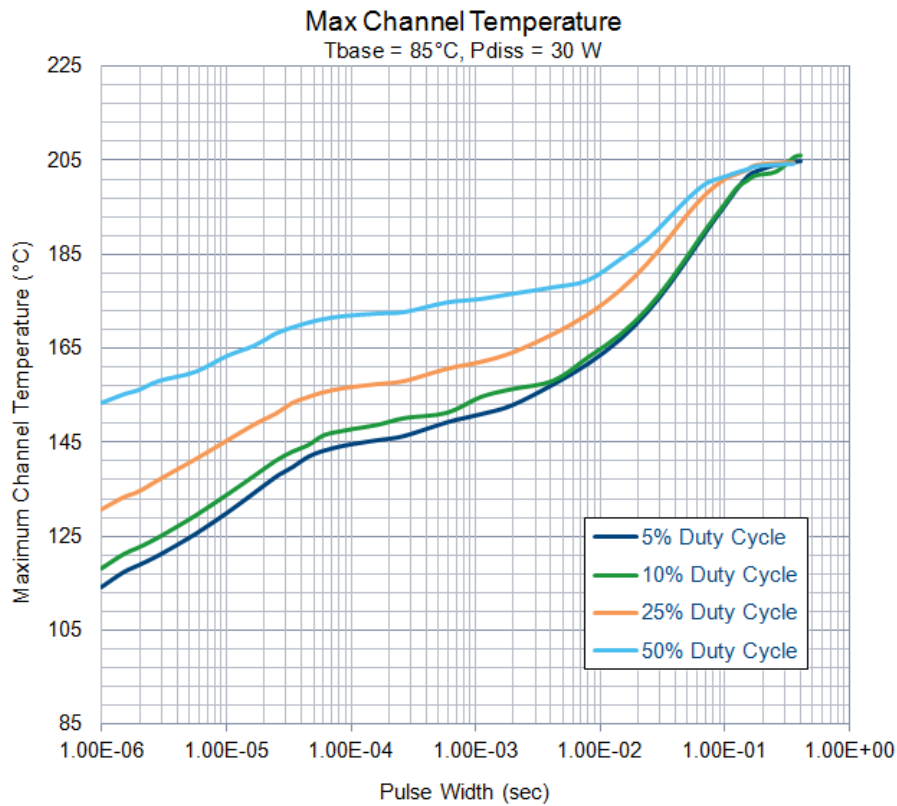
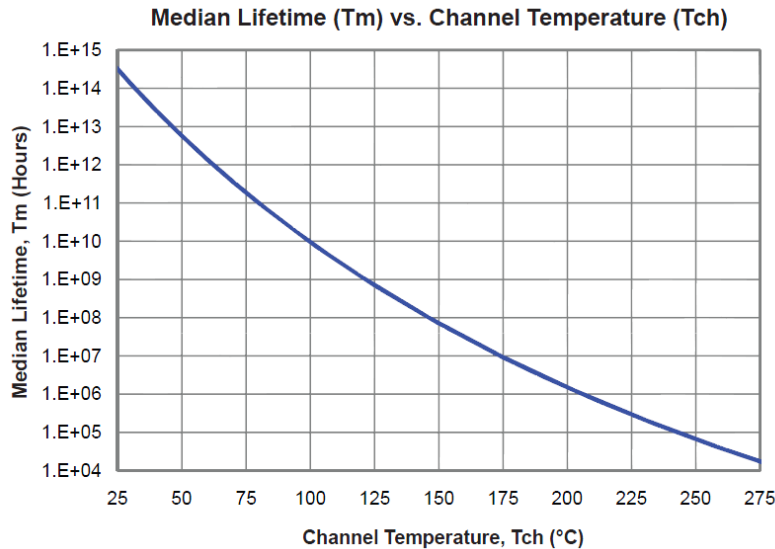

T1G6003028-FS

30W, 28V, DC – 6 GHz, GaN RF Power Transistor



Load Pull Smith Chart

RF performance that the device typically exhibits when placed in the specified impedance environment. The impedances are not the impedances of the device, they are the impedances presented to the device via an RF circuit or load-pull system. The impedances listed follow an optimized trajectory to maintain high power and high efficiency.

Test Conditions: $V_{DS} = 28\text{ V}$, $I_{DQ} = 200\text{ mA}$

Test Signal: Pulse Width = 100 μsec , Duty Cycle = 20%

Load-Pull Data at 3 GHz

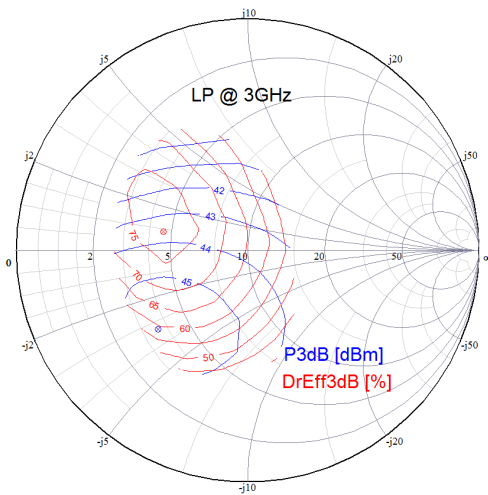

Load-Pull Data at 4 GHz

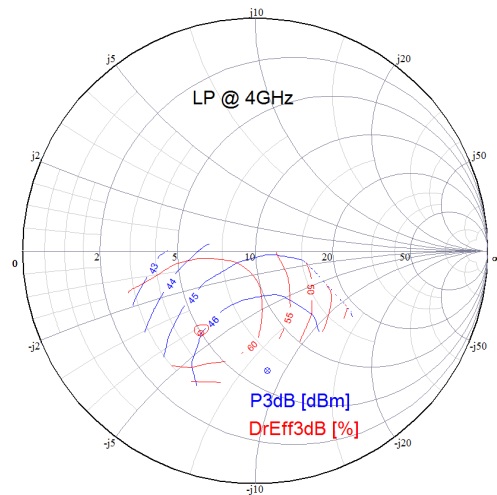

Load-Pull Data at 5 GHz

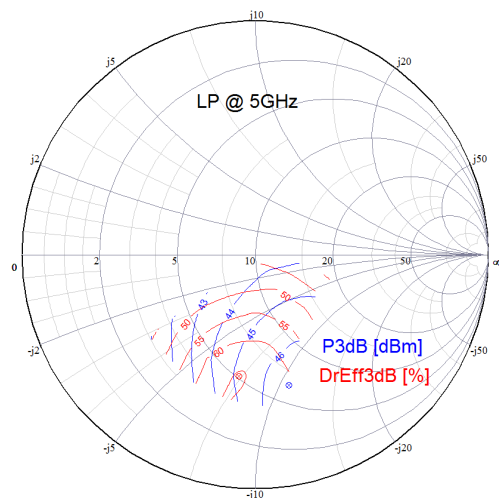

Load-Pull Data at 6 GHz

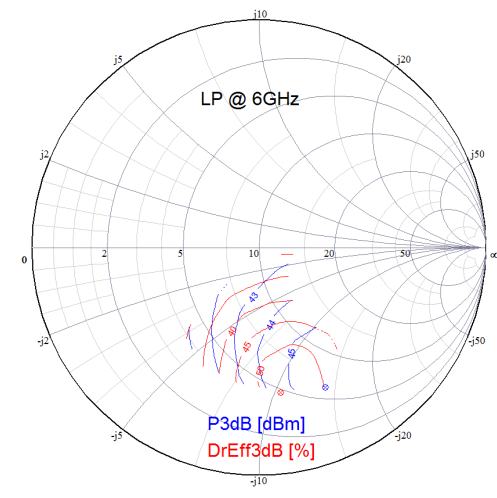

T1G6003028-FS

30W, 28V, DC – 6 GHz, GaN RF Power Transistor



Typical Performance (cont.)

Performance is measured at DUT reference plane

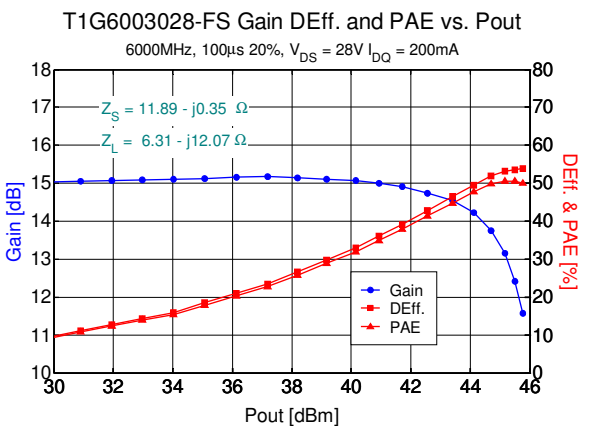
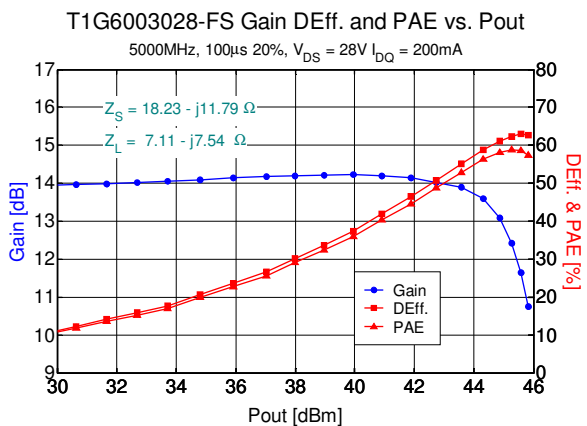
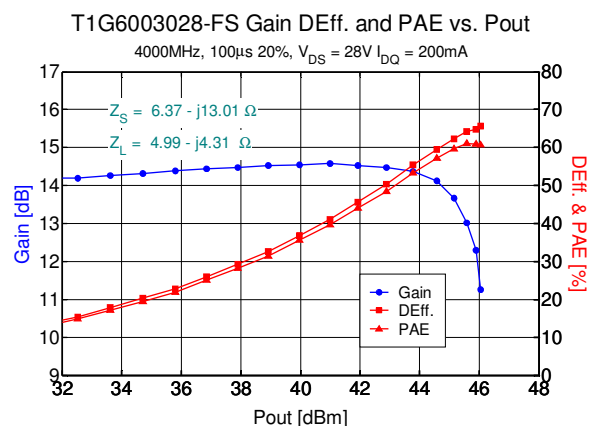
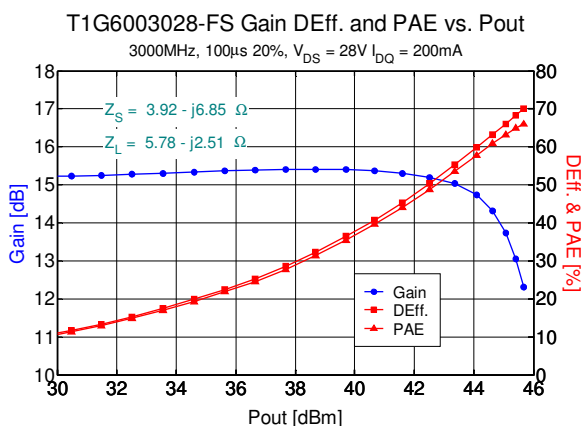
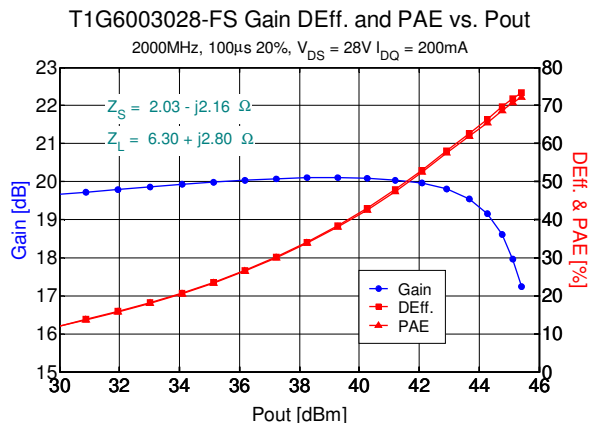
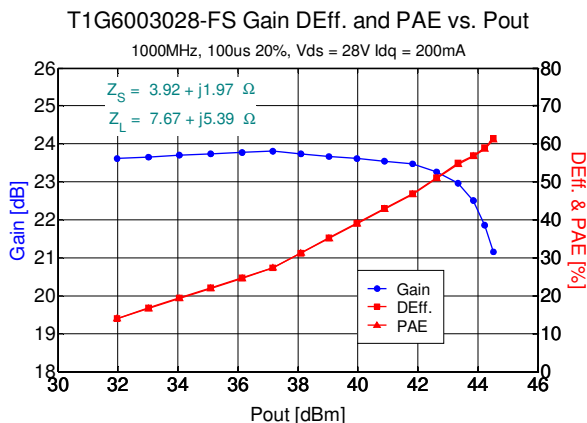

T1G6003028-FS

30W, 28V, DC – 6 GHz, GaN RF Power Transistor



Performance over Temperature: Gain, Efficiency and Output Power

Performance measured in TriQuint's 5.4 GHz to 5.9 GHz Evaluation Board at 3 dB compression.

T1G6003028-FS Gain vs. Temp.
 $V_{DS} = 28\text{ V}$, $I_{DQ} = 200\text{ mA}$; Pulse: 100 μs , 20%

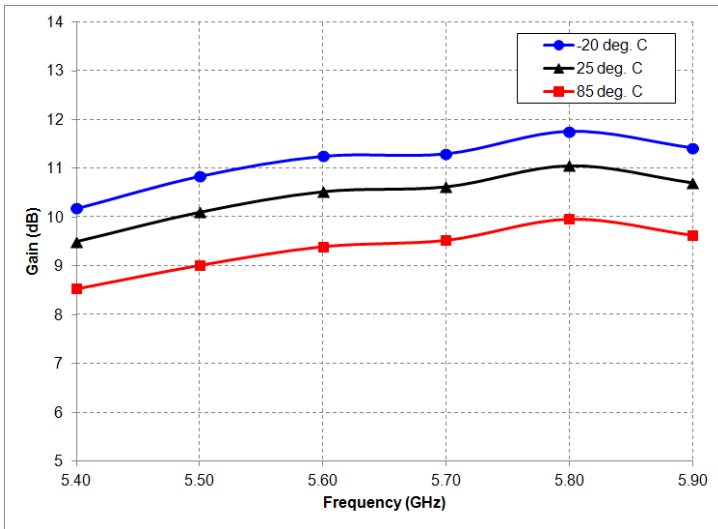

T1G6003028-FS Power vs. Temp.
 $V_{DS} = 28\text{ V}$, $I_{DQ} = 200\text{ mA}$; Pulse: 100 μs , 20%

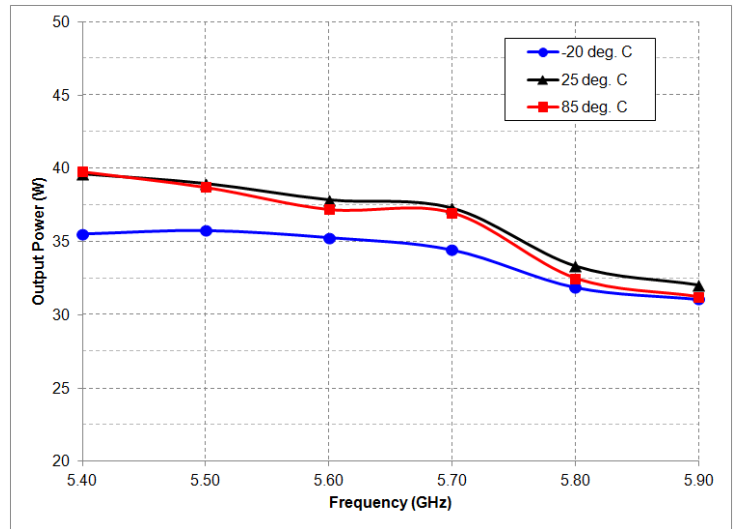

T1G6003028-FS Drain Eff. vs. Temp.
 $V_{DS} = 28\text{ V}$, $I_{DQ} = 200\text{ mA}$; Pulse: 100 μs , 20%

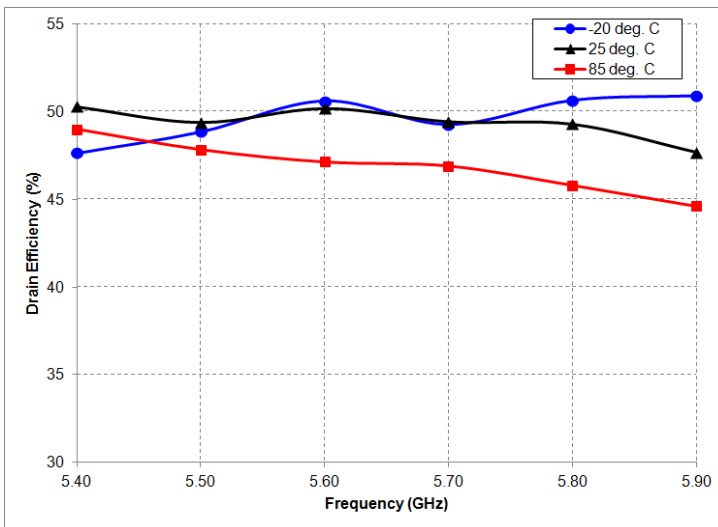

T1G6003028-FS PAE vs. Temp.
 $V_{DS} = 28\text{ V}$, $I_{DQ} = 200\text{ mA}$; Pulse: 100 μs , 20%

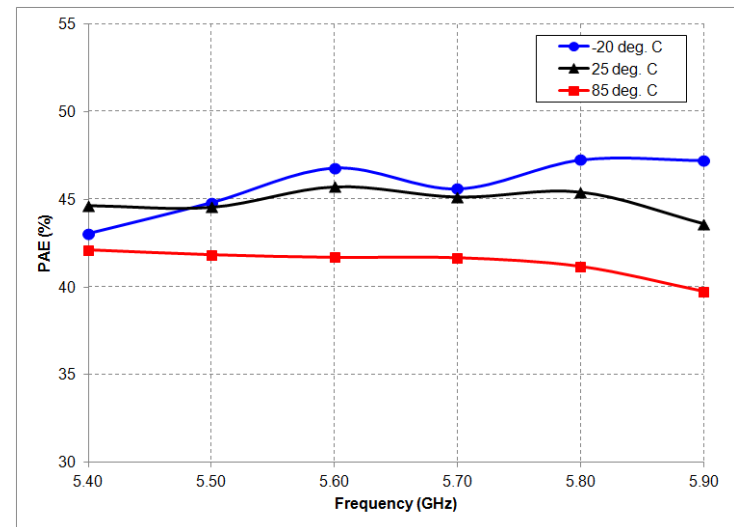

T1G6003028-FS

30W, 28V, DC – 6 GHz, GaN RF Power Transistor



Evaluation Board Performance: 5.4 to 5.9 GHz

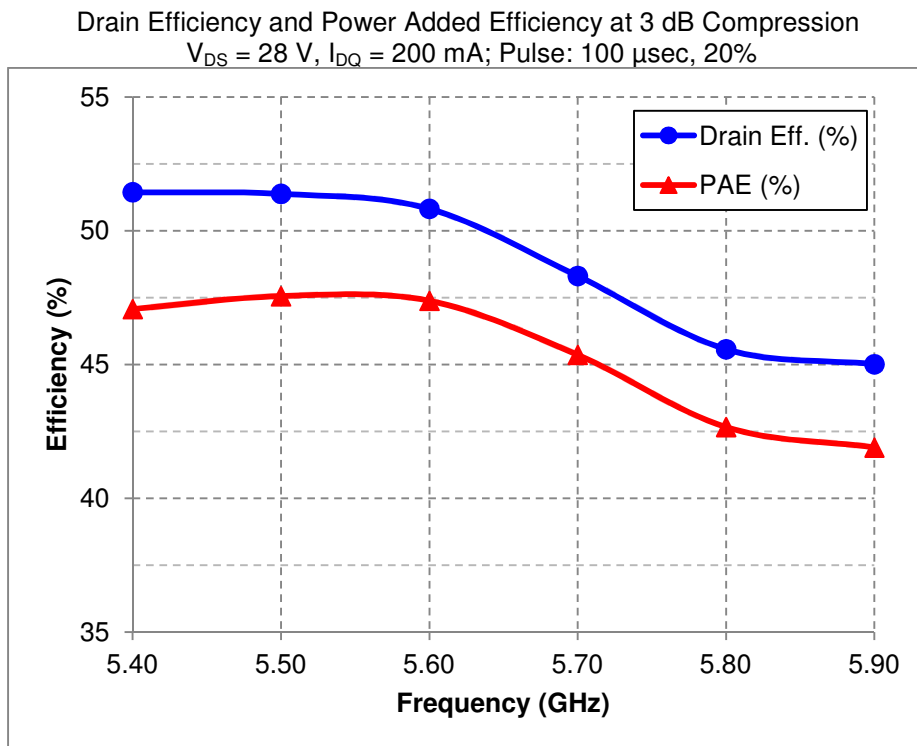
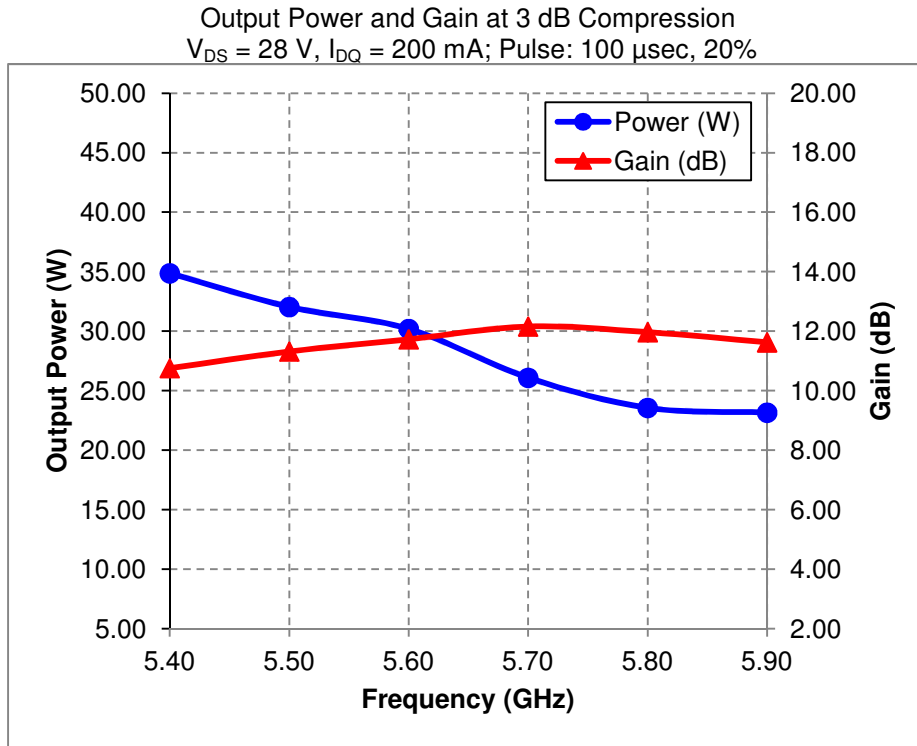

T1G6003028-FS

30W, 28V, DC – 6 GHz, GaN RF Power Transistor



Application Circuit

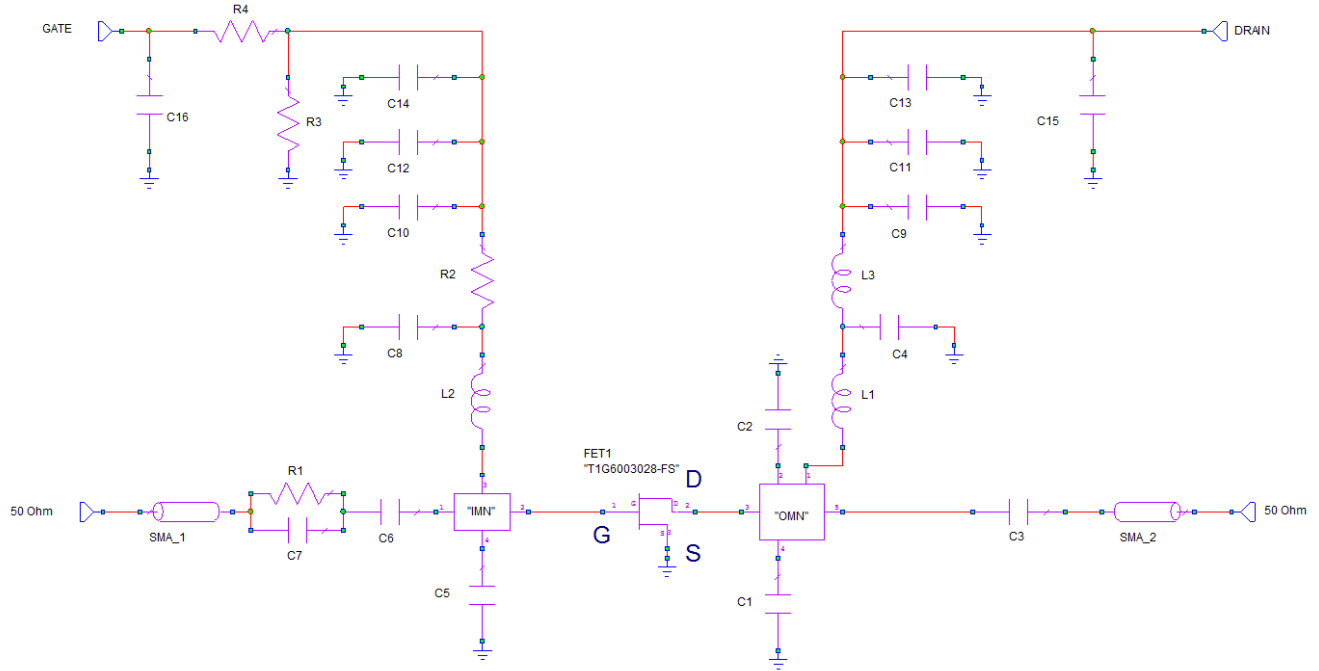

Bias-up Procedure

- Vg set to -5.0V
- Vd set to 28 V
- Adjust Vg more positive until quiescent Id is 200 mA. This will be ~ Vg = -3.6 V typical
- Apply RF signal

Bias-down Procedure

- Turn off RF signal
- Turn off Vd and wait 1 second to allow drain capacitor dissipation
- Turn off Vg

T1G6003028-FS

30W, 28V, DC – 6 GHz, GaN RF Power Transistor



Applications Information

Evaluation Board Layout

Top RF layer is 0.020" thick Rogers RO4350B, $\epsilon_r = 3.48$.

The pad pattern shown has been developed and tested for optimized assembly at TriQuint Semiconductor. The PCB land pattern has been developed to accommodate lead and package tolerances.

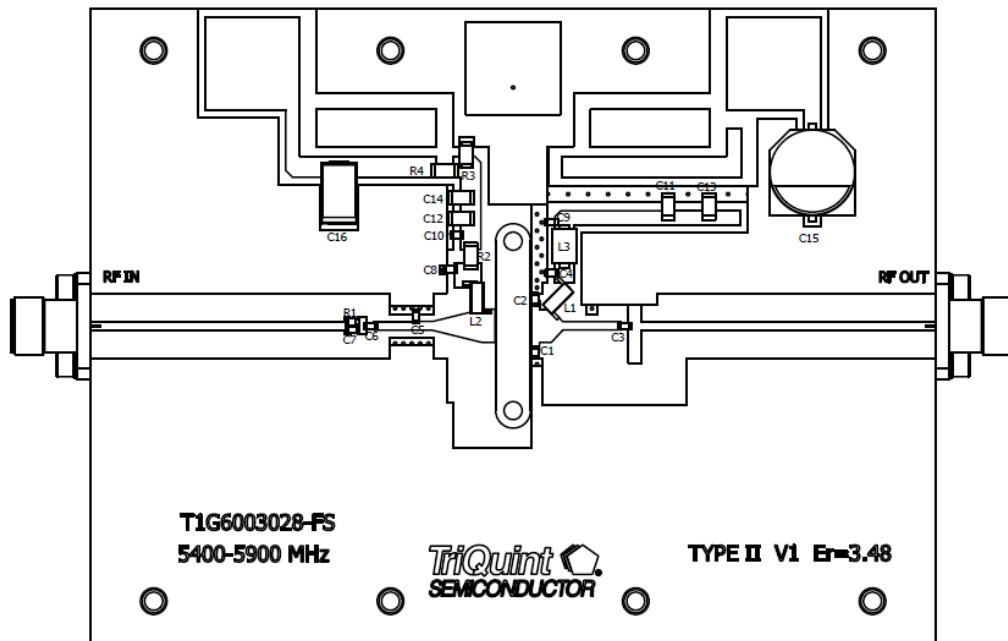

Bill of Materials

Reference Des.	Value	Qty	Manufacturer	Part Number
C1	0.3 pF	1	ATC	ATC600S0R3
C2	0.2 pF	1	ATC	ATC600S0R2
L1, L2	8.8 NH	2	COILCRAFT	1606-8
C3, C4, C6, C7, C8	3 pF	5	ATC	ATC600S3R0
C5	0.4 pF	1	ATC	ATC600S0R5
R1	97.6 Ohms	1	Venkel	CR0604-16w-97R6FT
R2	4.7 Ohms	1	Newark	37C0064
R3	330 Ohms	1	Newark	TNPW1206330RBT9ET1-E3
R4	50 Ohms	1	ATC	CRCW120651R0FKEA
C9, C10	220 pF	2	AVX	AVX06035C22KAT2A
C11, C12	2200 pF	2	Vitramon	VJ1206Y222KXA
C13, C14	22000 pF	2	Vitramon	VJ1206Y223KXA
C15	220 uF	1	United Chemi-Con	EMVY500ADA221MJA0G
C16	1.0 uF	1	Allied	541-1231
L3	48 Ohm	1	Ferrite, Laird Tech.	28F0121-0SR-10

T1G6003028-FS

30W, 28V, DC – 6 GHz, GaN RF Power Transistor

PIN Description

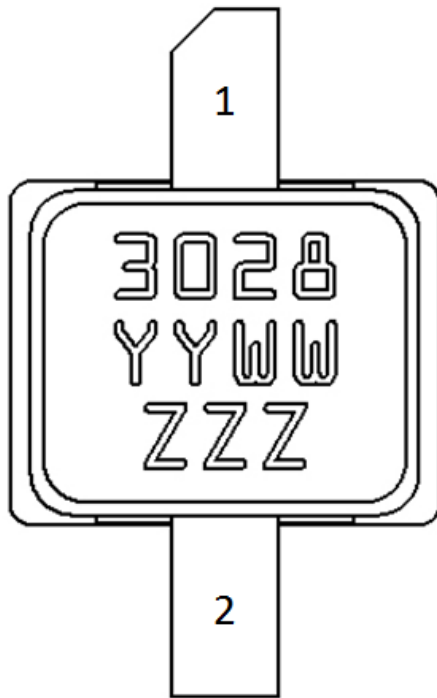

TOP VIEW

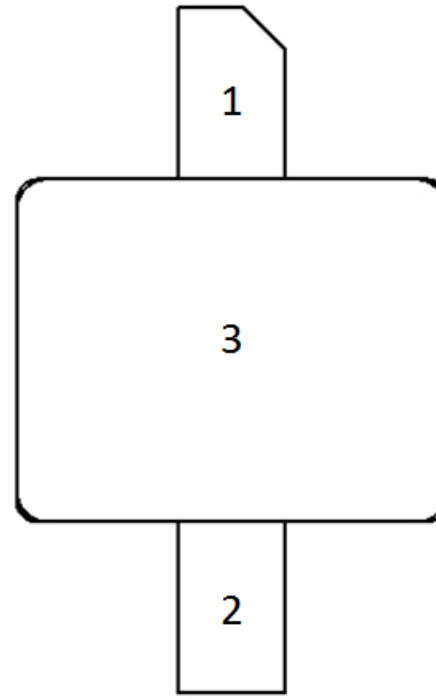

BOTTOM VIEW

Pin	Symbol	Description
1	Vd/ RF OUT	Drain voltage/ RF Output matched to 50 ohms; see Application Circuit on page 8 as an example.
2	Vg/RF IN	Gate voltage/ RF Input matched to 50 ohms; see Application Circuit on page 8 as an example
3	Flange	Source connected to ground; see Application Circuit on page 8 as an example.

The T1G6003028-FS will be marked with the “3028” designator and a lot code marked below the part designator. The “YY” represents the last two digits of the year the part was manufactured, the “WW” is the work week, and the “ZZZ” is an auto-generated number.

T1G6003028-FS

30W, 28V, DC – 6 GHz, GaN RF Power Transistor

Mechanical Information

Package Information and Dimensions

All dimensions are in millimeters.

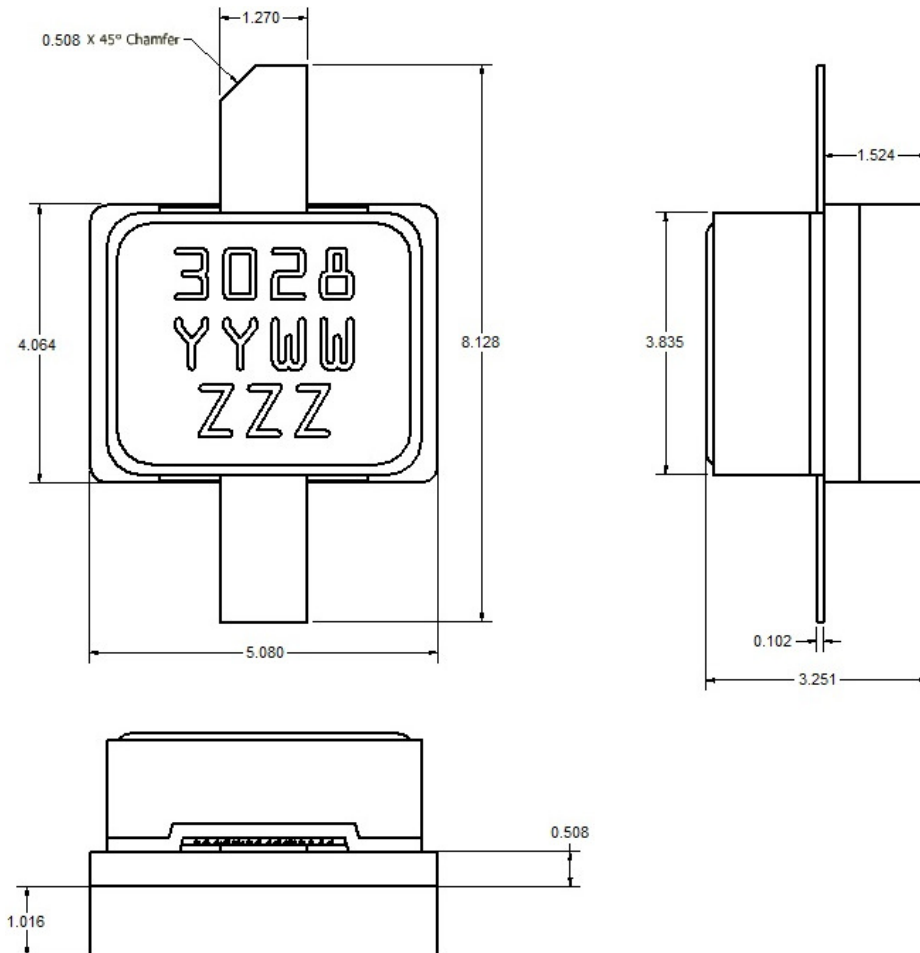

This package is lead-free/RoHS-compliant. The plating material on the leads is NiAu. It is compatible with both lead-free (maximum 260 °C reflow temperature) and tin-lead (maximum 245 °C reflow temperature) soldering processes.

T1G6003028-FS

30W, 28V, DC – 6 GHz, GaN RF Power Transistor

Product Compliance Information

ESD Information



Caution! ESD-Sensitive Device

ESD Rating: Class 1A
Value: ≥ 250 V
Test: Human Body Model (HBM)
Standard: JEDEC Standard JESD22-A114

MSL Rating

Level 3 at +260 °C convection reflow
The part is rated Moisture Sensitivity Level 3 at 260 °C per JEDEC standard IPC/JEDEC J-STD-020.

ECCN

US Department of Commerce EAR99

Solderability

Compatible with the latest version of J-STD-020, Lead free solder, 260 °C

This part is compliant with EU 2002/95/EC RoHS directive (Restrictions on the Use of Certain Hazardous Substances in Electrical and Electronic Equipment).

This product also has the following attributes:

- Lead Free
- Halogen Free (Chlorine, Bromine)
- Antimony Free
- TBBP-A (C₁₅H₁₂Br₄O₂) Free
- PFOS Free
- SVHC Free

Recommended Soldering Temperature Profile

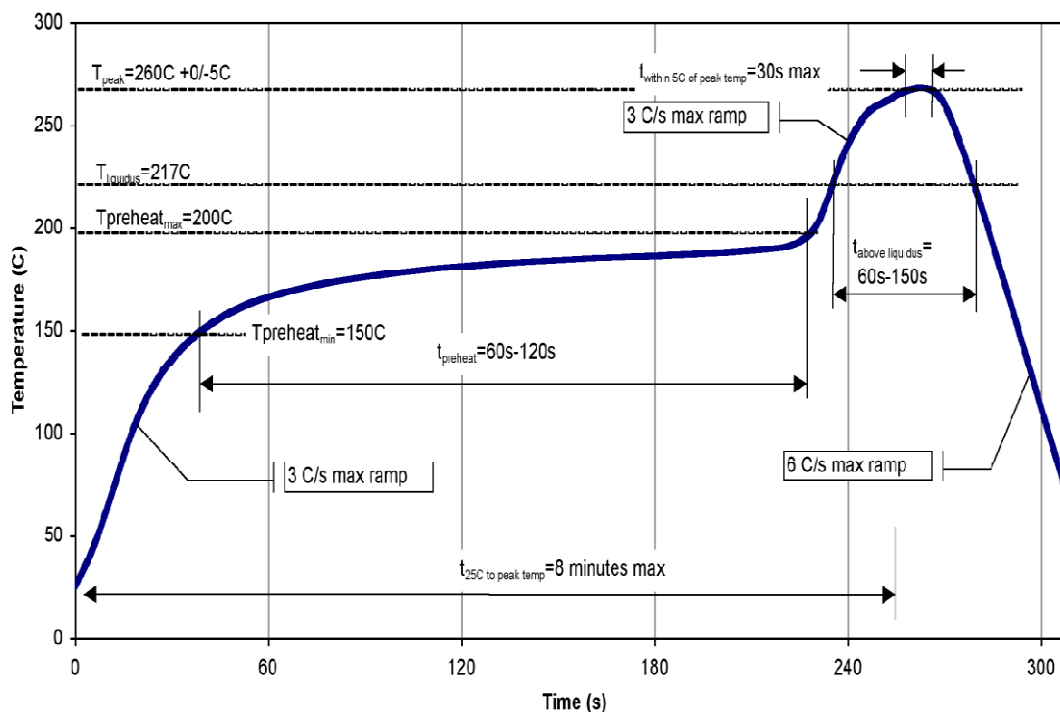

T1G6003028-FS

30W, 28V, DC – 6 GHz, GaN RF Power Transistor



Contact Information

For the latest specifications, additional product information, worldwide sales and distribution locations, and information about TriQuint:

Web: www.triquint.com
Email: info-sales@tqs.com

Tel: +1.972.994.8465
Fax: +1.972.994.8504

For technical questions and application information:

Email: info-products@tqs.com

Important Notice

The information contained herein is believed to be reliable. TriQuint makes no warranties regarding the information contained herein. TriQuint assumes no responsibility or liability whatsoever for any of the information contained herein. TriQuint assumes no responsibility or liability whatsoever for the use of the information contained herein. The information contained herein is provided "AS IS, WHERE IS" and with all faults, and the entire risk associated with such information is entirely with the user. All information contained herein is subject to change without notice. Customers should obtain and verify the latest relevant information before placing orders for TriQuint products. The information contained herein or any use of such information does not grant, explicitly or implicitly, to any party any patent rights, licenses, or any other intellectual property rights, whether with regard to such information itself or anything described by such information.

TriQuint products are not warranted or authorized for use as critical components in medical, life-saving, or life-sustaining applications, or other applications where a failure would reasonably be expected to cause severe personal injury or death.