

## Features

- Attenuation: 1 dB Steps to 50 dB
- Low DC Power Consumption
- Integral TTL Driver
- 50 ohm Impedance
- Test Boards are Available
- Tape and Reel Packaging Available
- SOW-24 Package

## Schematic with Off-Chip Components

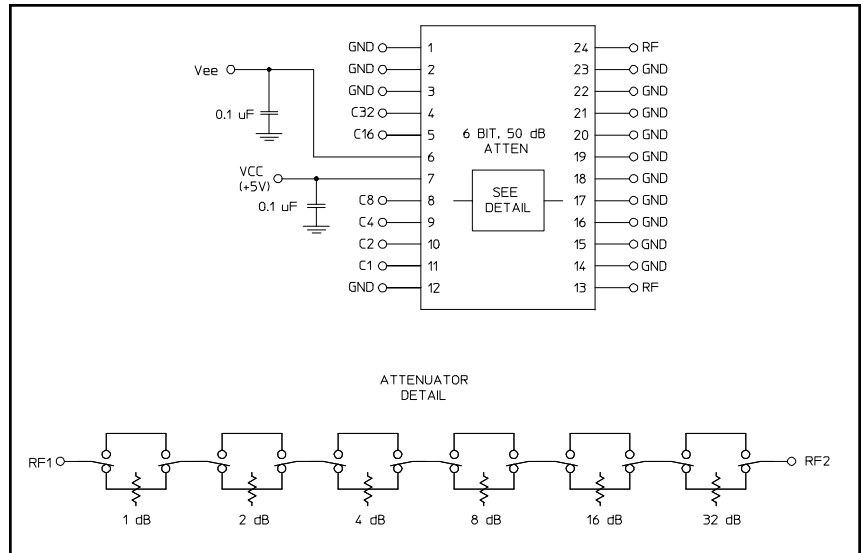

## Description

M/A-COM's AT65-0106 is a GaAs FET 6-bit digital attenuator with a 1 dB minimum step size and a 50 dB total attenuation range. This device is in a SOW-24, wide body plastic surface mount package. The AT65-0106 is ideally suited for use where accuracy, fast speed, very low power consumption and low costs are required.

## Ordering Information

Part Number	Package
AT65-0106	Bulk Packaging
AT65-0106TR	1000 piece reel
AT65-0106-TB	Sample Test Board

Note: Reference Application Note M513 for reel size information.

## Pin Configuration

Pin No.	Function	Pin No.	Function
1	GND	13	RF
2	GND	14	GND
3	GND	15	GND
4	C32	16	GND
5	C16	17	GND
6	V <sub>EE</sub>	18	GND
7	V <sub>CC</sub>	19	GND
8	C8	20	GND
9	C4	21	GND
10	C2	22	GND
11	C1	23	GND
12	GND	24	RF

## Electrical Specifications: $T_A = 25^\circ\text{C}$ , $Z_0 = 50\Omega$

Parameter	Test Conditions	Frequency	Units	Min	Typ	Max
Insertion Loss	—	DC - 2.0 GHz	dB	—	4.2	4.7
Attenuation Accuracy	Individual Bits 1-2-4-8-16-32 dB Any Combination of Bits 3 to 15 dB Any Combination of Bits 17 to 31 dB Any Combination of Bits 32 to 50 dB	DC - 2.0 GHz DC - 2.0 GHz DC - 2.0 GHz DC - 2.0 GHz	dB dB dB dB	— — — —	— — — —	$\pm(.3 + 3\%$ of atten setting) $\pm(.5 + 5\%$ of atten setting) $\pm(.3 + 3\%$ of atten setting) $\pm(.5 + 7\%$ of atten setting)
VSWR	Full Range	DC - 2.0 GHz	Ratio	—	1.8:1	2:1
Switching Speed <sup>1</sup>	50% Cntl to 90%/10% RF 10% to 90% or 90% to 10%	— —	ns ns	— —	75 20	150 50
1 dB Compression	— —	50 MHz 0.5 - 2.0 GHz	dBm dBm	— —	+21 +24	— —
Input IP <sub>3</sub>	Two-tone inputs up to +5 dBm @ 0 dB Attenuation	50 MHz 0.5-2.0 GHz	dB dB	— —	+35 +48	— —
V <sub>CC</sub> V <sub>EE</sub>	— —	— —	V V	4.75 -8.0	5.0 -5.0	5.25 -4.75
V <sub>IL</sub> V <sub>IH</sub>	LOW-level input voltage HIGH-level input voltage	— —	V V	0.0 2.0	— —	0.8 5.0
I <sub>in</sub> (Input Leakage Current)	V <sub>in</sub> = V <sub>CC</sub> or GND	—	uA	-1.0	—	1.0
I <sub>CC</sub> (Quiescent Supply Current)	V <sub>cntrl</sub> = V <sub>CC</sub> or GND	—	uA	—	250	400
$\Delta I_{CC}$ (Additional Supply Current Per TTL Input Pin)	V <sub>CC</sub> = Max, V <sub>cntrl</sub> = V <sub>CC</sub> - 2.1 V	—	mA	—	—	1.0
I <sub>EE</sub>	V <sub>EE</sub> min to max, V <sub>in</sub> = V <sub>IL</sub> or V <sub>IH</sub>	—	mA	-1.0	-0.2	—
Thermal Resistance $\theta_{JA}$	PCB mount on FR4 material, copper trace, still air at +25°C	—	°C/W	—	60-80	—

1. Decoupling capacitors (.01 $\mu$ F) are required on power supply lines.

## Absolute Maximum Ratings<sup>2,3</sup>

Parameter	Absolute Maximum
Max. Input Power 0.05 GHz 0.5 - 2.0 GHz	+27 dBm +34 dBm
V <sub>CC</sub>	-0.5V $\leq$ V <sub>CC</sub> $\leq$ +7.0V
V <sub>EE</sub>	-8.5V $\leq$ V <sub>EE</sub> $\leq$ +0.5V
V <sub>CC</sub> - V <sub>EE</sub>	-0.5V $\leq$ V <sub>CC</sub> - V <sub>EE</sub> $\leq$ 14.5V
V <sub>in</sub> <sup>4</sup>	-0.5V $\leq$ V <sub>in</sub> $\leq$ V <sub>CC</sub> + 0.5V
Operating Temperature	-40°C to +85°C
Storage Temperature	-65°C to +125°C

- Exceeding any one or combination of these limits may cause permanent damage to this device.
- M/A-COM does not recommend sustained operation near these survivability limits.
- Standard CMOS TTL interface, latch-up will occur if logic signal is applied prior to power supply.

## Handling Procedures

Please observe the following precautions to avoid damage:

## Static Sensitivity

Gallium Arsenide Integrated Circuits are sensitive to electrostatic discharge (ESD) and can be damaged by static electricity. Proper ESD control techniques should be used when handling these devices.

## Truth Table (Digital Attenuator)

C32	C16	C8	C4	C2	C1	Attenuation
0	0	0	0	0	0	Loss, Reference
0	0	0	0	0	1	1 dB
0	0	0	0	1	0	2 dB
0	0	0	1	0	0	4 dB
0	0	1	0	0	0	8 dB
0	1	0	0	0	0	16 dB
1	0	0	0	0	0	32 dB
1	1	0	0	1	0	50 dB

0 = TTL Low; 1 = TTL High

## Typical Performance Curves

### Insertion Loss vs. Temperature

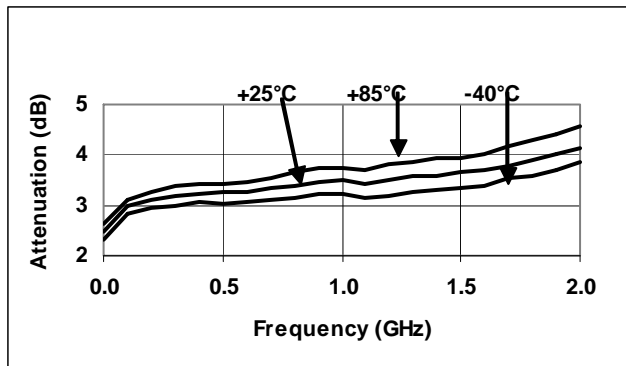

### 1 dB Attenuation Variation from -40°C to +85°C

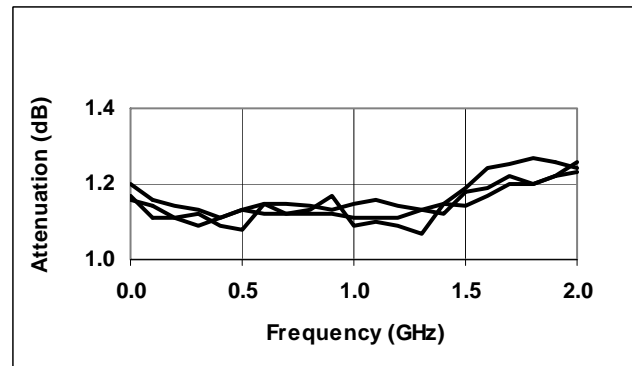

### 2 dB Attenuation Variation from -40°C to +85°C

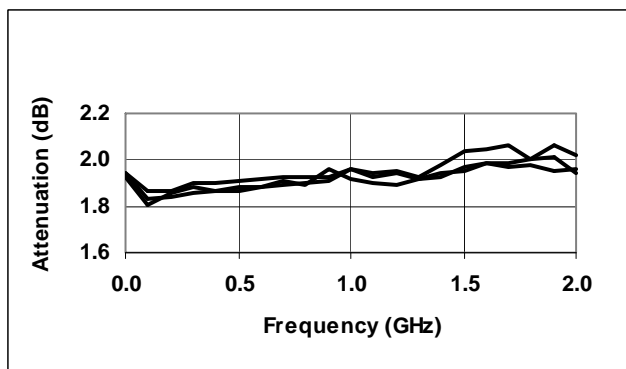

### 4 dB Attenuation Variation from -40°C to +85°C

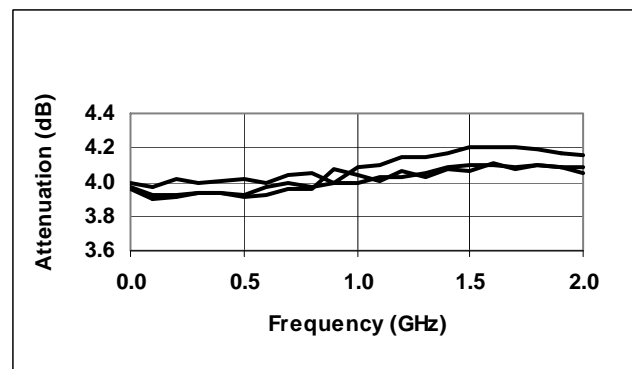

## Typical Performance Curves

8 dB Attenuation Variation from -40°C to +85°C

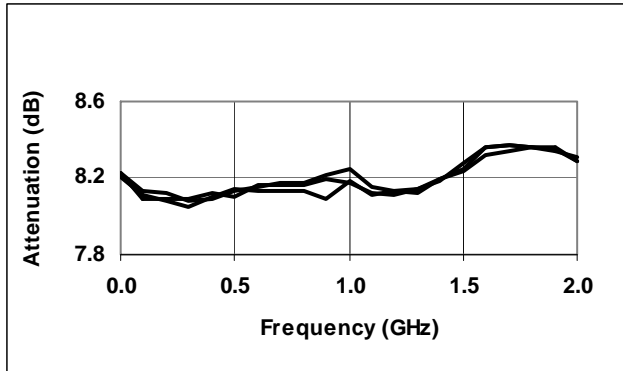

16 dB Attenuation Variation from -40°C to +85°C

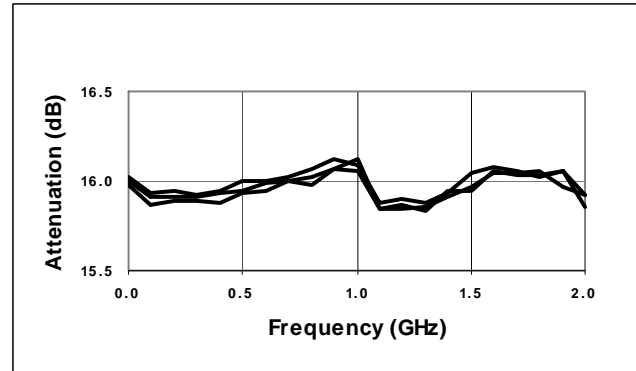

32 dB Attenuation Variation from -40°C to +85°C

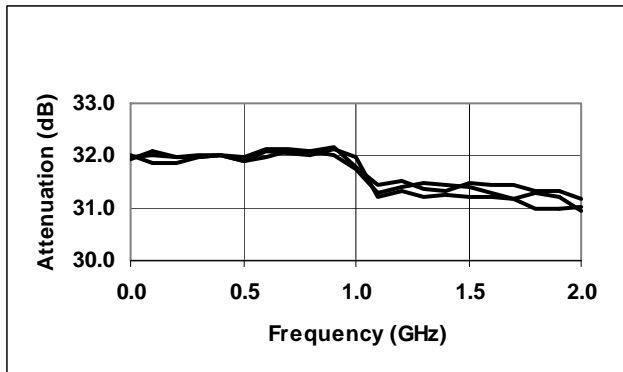

Max. Attenuation Variation from -40°C to +85°C

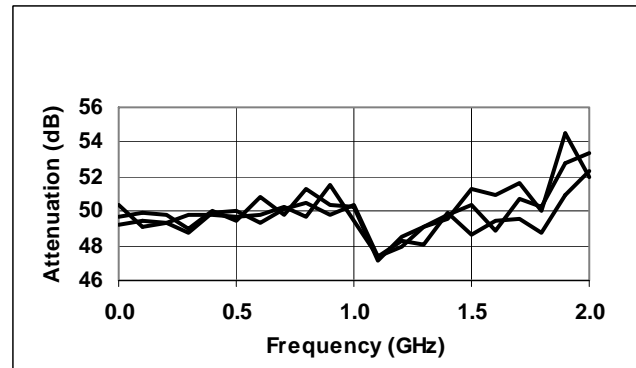

Reference Loss VSWR (S11, S22)

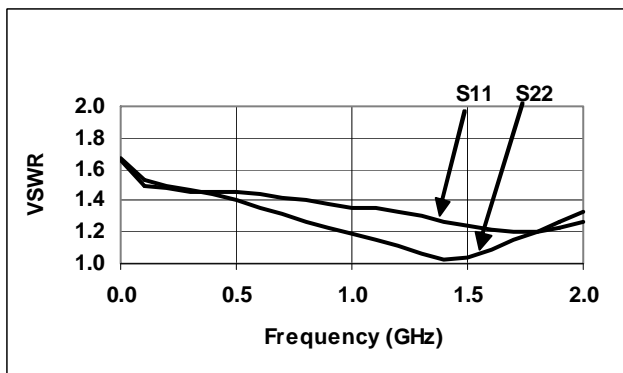

1 dB VSWR (S11, S22)

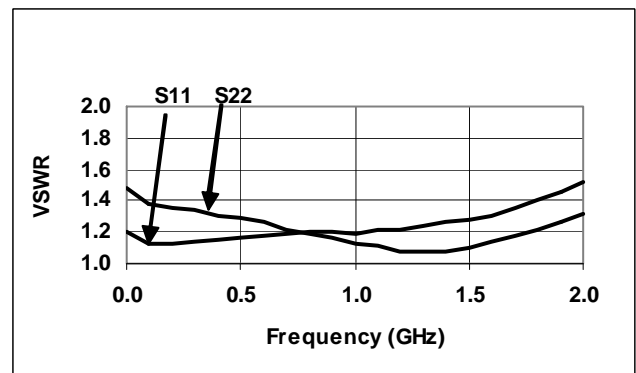

## Typical Performance Curves

2 dB VSWR (S11, S22)

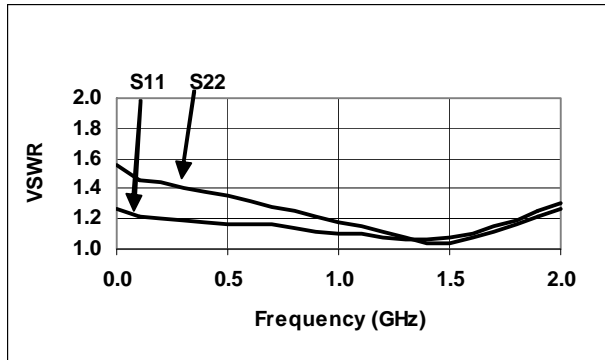

4 dB VSWR (S11, S22)

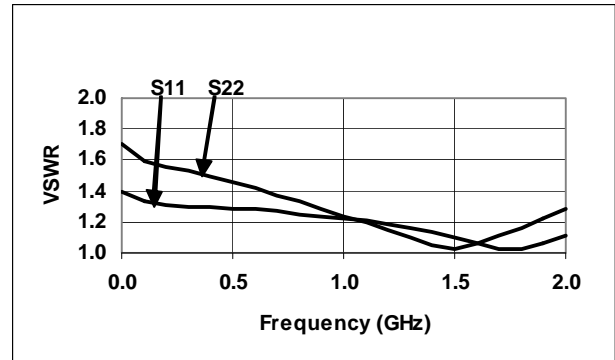

8 dB VSWR (S11, S22)

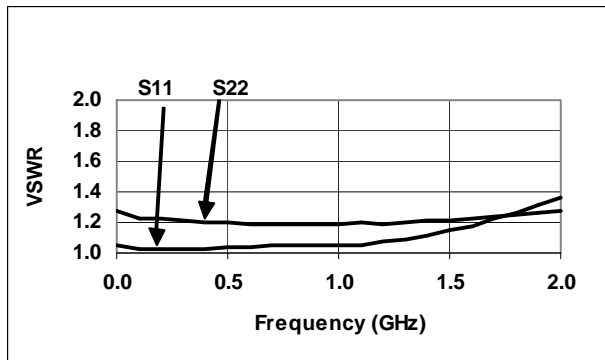

16 dB VSWR (S11, S22)

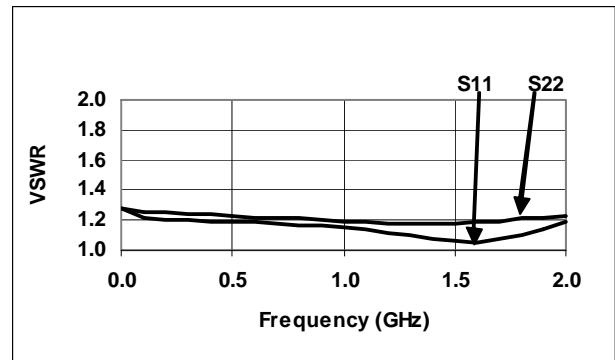

32 dB VSWR (S11, S22)

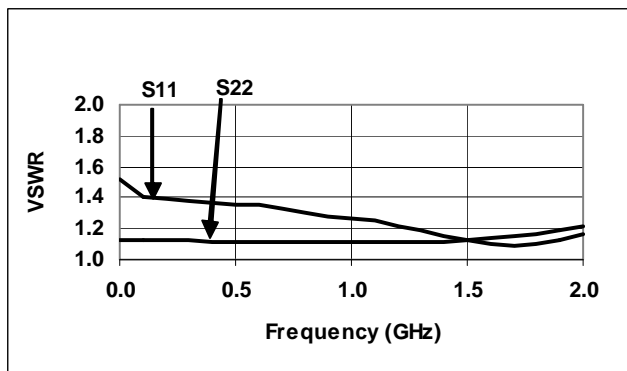

50 dB VSWR (S11, S22)

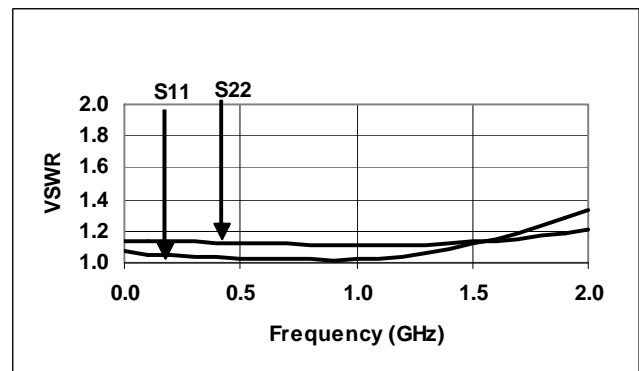

# AT65-0106

Digital Attenuator  
50 dB, 6-Bit, TTL Driver, DC-2.0 GHz

Rev. V9

## SOW-24<sup>†</sup>

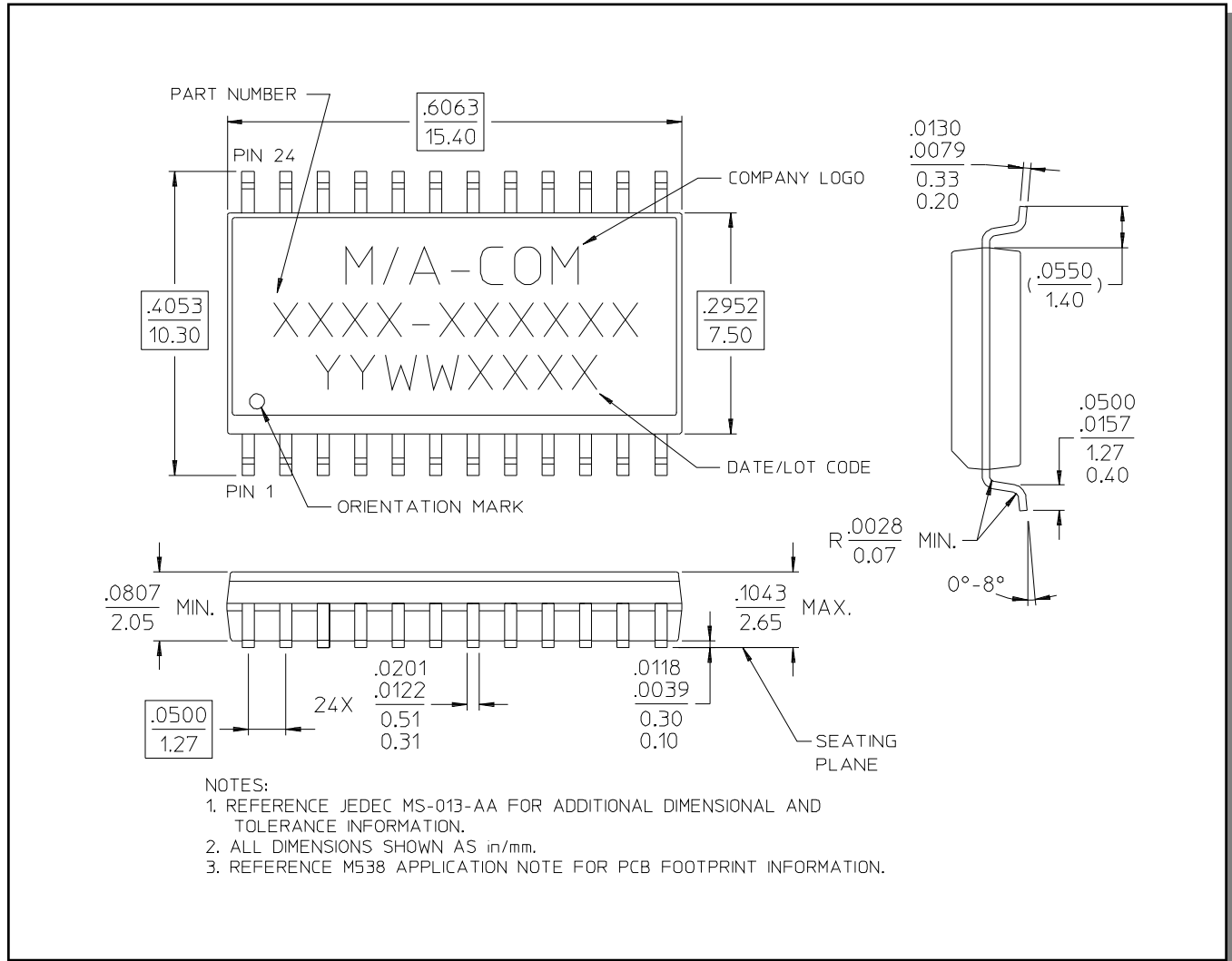

<sup>†</sup> Reference Application Note M538 for lead-free solder reflow recommendations.