

## Axial Lead Transient Voltage Suppressors (TVS)

**1.5KE Series    6.8 To 600 V    1500W**

### Description

The 1.5KE series is designed specifically to protect sensitive electronic equipment from voltage transients induced by lightning and other transient voltage events.

### Features

- u Glass passivated chip junction in DO-201 Package
- u Low leakage
- u Uni and Bidirectional unit
- u Excellent clamping capability
- u 1500W Peak power capability at 10 × 1000µs waveform Repetition rate (duty cycle):0.01%
- u Fast response time: typically less than 1.0ps from 0 Volts to  $V_{BR}$  min
- u Typical  $I_R$  less than 5µA above 12V.
- u High Temperature soldering: 260°C/40 seconds at terminals
- u Typical maximum temperature coefficient  $\Delta V_{BR} = 0.1\% \times V_{BR}@25^\circ\text{C} \times \Delta T$
- u Plastic package has Underwriters Laboratory Flammability 94V-0
- u Matte tin lead-free Plated
- u Halogen free and RoHS compliant
- u Typical failure mode is short from over-specified voltage or current
- u Whisker test is conducted based on JEDEC JESD201A per its table 4a and 4c
- u IEC-61000-4-2 ESD 15kV(Air), 8kV (Contact)
- u ESD protection of data lines in accordance with IEC 61000-4-2 (IEC801-2)
- u EFT protection of data lines in accordance with IEC 61000-4-4 (IEC801-4)

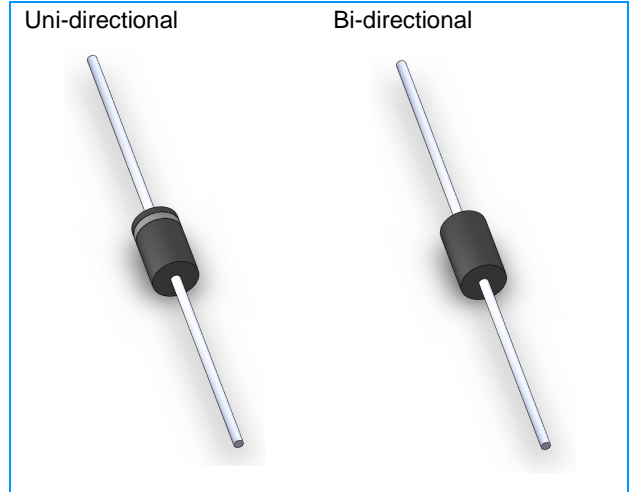

### Functional Diagram

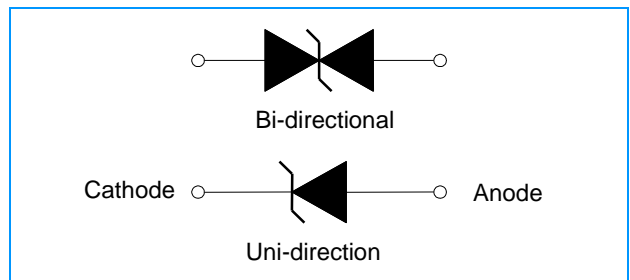

### Applications

TVS devices are ideal for the protection of I/O interfaces,  $V_{CC}$  bus and other vulnerable circuits used in Telecom, Computer, Industrial and Consumer electronic applications.

### Maximum Ratings ( $T_A=25^\circ\text{C}$ unless otherwise noted)

Parameter	Symbol	Value	Unit
Peak Pulse Power Dissipation with a 10/1000µs waveform (Fig.1)(Note 1), (Note 2)	$P_{PPM}$	1500	Watts
Peak Pulse Current with a 10/1000µs waveform.(Note1, Fig.3)	$I_{PP}$	See Next Table	Amps
Power Dissipation on Infinite Heat Sink at $T_L=75^\circ\text{C}$	$P_{M(AV)}$	6.5	Watt
Peak Forward Surge Current, 8.3ms Single Half Sine Wave (Note 3)	$I_{FSM}$	200	Amps
Maximum Instantaneous Forward Voltage at 25A for Unidirectional Only (Note 4)	$V_F$	3.5/5.0	Voltage
Operating junction and Storage Temperature Range.	$T_J, T_{STG}$	-55 to +150	$^\circ\text{C}$

### Notes:

1. Non-repetitive current pulse, per Fig. 3 and derated above  $T_A = 25^\circ\text{C}$  per Fig. 2.
2. Mounted on 5.0mm x 5.0mm (0.03mm thick) Copper Pads to each terminal.
3. 8.3ms single half sine-wave, or equivalent square wave, Duty cycle = 4 pulses per minutes maximum.
4.  $V_F < 3.5\text{V}$  for  $V_{BR} < 200\text{V}$  and  $V_F < 6.5\text{V}$  for  $V_{BR} > 201\text{V}$ .

## Axial Lead Transient Voltage Suppressors (TVS)

**1.5KE Series 6.8 To 600 V 1500W**
**Electrical Characteristics (T<sub>A</sub>=25°C unless otherwise noted)**

Part Number		Reverse Stand-Off Voltage V <sub>RWM</sub> (V)	Breakdown Voltage V <sub>BR</sub> (V) @I <sub>T</sub>		Test Current I <sub>T</sub> (mA)	Maximum Clamping Voltage V <sub>C</sub> @I <sub>PP</sub> (V)	Maximum Peak Pulse Current I <sub>PP</sub> (A)	Maximum Reverse Leakage I <sub>R</sub> @V <sub>RWM</sub> (μA)
Uni	Bi		MIN	MAX				
1.5KE6.8	1.5KE6.8C	5.5	6.12	7.48	10	10.8	138.89	1000
1.5KE6.8A	1.5KE6.8CA	5.8	6.46	7.14	10	10.5	142.86	1000
1.5KE7.5	1.5KE7.5C	6.1	6.75	8.25	10	11.7	128.21	500
1.5KE7.5A	1.5KE7.5CA	6.4	7.13	7.88	10	11.3	132.74	500
1.5KE8.2	1.5KE8.2C	6.6	7.38	9.02	10	12.5	120.00	200
1.5KE8.2A	1.5KE8.2CA	7.0	7.79	8.61	10	12.1	123.97	200
1.5KE9.1	1.5KE9.1C	7.4	8.19	10.01	1	13.8	108.70	50
1.5KE9.1A	1.5KE9.1CA	7.8	8.65	9.56	1	13.4	111.94	50
1.5KE10	1.5KE10C	8.1	9.00	11.00	1	15.0	100.00	10
1.5KE10A	1.5KE10CA	8.6	9.50	10.50	1	14.5	103.45	10
1.5KE11	1.5KE11C	8.9	9.90	12.10	1	16.2	92.59	5
1.5KE11A	1.5KE11CA	9.4	10.45	11.55	1	15.6	96.15	5
1.5KE12	1.5KE12C	9.7	10.80	13.20	1	17.3	86.71	5
1.5KE12A	1.5KE12CA	10.2	11.40	12.60	1	16.7	89.82	5
1.5KE13	1.5KE13C	10.5	11.70	14.30	1	19.0	78.95	5
1.5KE13A	1.5KE13CA	11.1	12.35	13.65	1	18.2	82.42	5
1.5KE15	1.5KE15C	12.1	13.50	16.50	1	22.0	68.18	5
1.5KE15A	1.5KE15CA	12.8	14.25	15.75	1	21.2	70.75	5
1.5KE16	1.5KE16C	12.9	14.40	17.60	1	23.5	63.83	5
1.5KE16A	1.5KE16CA	13.6	15.20	16.80	1	22.5	66.67	5
1.5KE18	1.5KE18C	14.5	16.20	19.80	1	26.5	56.60	5
1.5KE18A	1.5KE18CA	15.3	17.10	18.90	1	25.2	59.52	5
1.5KE20	1.5KE20C	16.2	18.00	22.00	1	29.1	51.55	5
1.5KE20A	1.5KE20CA	17.1	19.00	21.00	1	27.7	54.15	5
1.5KE22	1.5KE22C	17.8	19.80	24.20	1	31.9	47.02	5
1.5KE22A	1.5KE22CA	18.8	20.90	23.10	1	30.6	49.02	5
1.5KE24	1.5KE24C	19.4	21.60	26.40	1	34.7	43.23	5
1.5KE24A	1.5KE24CA	20.5	22.80	25.20	1	33.2	45.18	5
1.5KE27	1.5KE27C	21.8	24.30	29.70	1	39.1	38.36	5
1.5KE27A	1.5KE27CA	23.1	25.65	28.35	1	37.5	40.00	5
1.5KE30	1.5KE30C	24.3	27.00	33.00	1	43.5	34.48	5
1.5KE30A	1.5KE30CA	25.6	28.50	31.50	1	41.4	36.23	5
1.5KE33	1.5KE33C	26.8	29.70	36.30	1	47.7	31.45	5
1.5KE33A	1.5KE33CA	28.2	31.35	34.65	1	45.7	32.82	5
1.5KE36	1.5KE36C	29.1	32.40	39.60	1	52.0	28.85	5
1.5KE36A	1.5KE36CA	30.8	34.20	37.80	1	49.9	30.06	5
1.5KE39	1.5KE39C	31.6	35.10	42.90	1	56.4	36.60	5
1.5KE39A	1.5KE39CA	33.3	37.05	40.95	1	53.9	27.83	5
1.5KE43	1.5KE43C	34.8	38.70	47.30	1	61.9	24.23	5
1.5KE43A	1.5KE43CA	36.8	40.85	45.15	1	59.3	25.30	5
1.5KE47	1.5KE47C	38.1	42.30	51.70	1	67.8	22.12	5
1.5KE47A	1.5KE47CA	40.2	44.65	49.35	1	64.8	23.15	5
1.5KE51	1.5KE51C	41.3	45.90	56.10	1	73.5	20.41	5
1.5KE51A	1.5KE51CA	43.6	48.45	53.55	1	70.1	21.40	5
1.5KE56	1.5KE56C	45.4	50.40	61.60	1	80.5	18.63	5
1.5KE56A	1.5KE56CA	47.8	53.20	58.80	1	77.0	19.48	5
1.5KE62	1.5KE62C	50.2	55.80	68.20	1	89.0	16.85	5
1.5KE62A	1.5KE62CA	53.0	58.90	65.10	1	85.0	17.65	5
1.5KE68	1.5KE68C	55.1	61.20	74.80	1	98.0	15.31	5
1.5KE68A	1.5KE68CA	58.1	64.60	71.40	1	92.0	16.30	5
1.5KE75	1.5KE75C	60.7	67.50	82.50	1	108.0	13.89	5
1.5KE75A	1.5KE75CA	64.1	71.25	78.75	1	103.0	14.56	5
1.5KE82	1.5KE82C	66.4	73.80	90.20	1	118.0	12.71	5
1.5KE82A	1.5KE82CA	70.1	77.90	86.10	1	113.0	13.27	5

## Axial Lead Transient Voltage Suppressors (TVS)

**1.5KE Series 6.8 To 600 V 1500W**
**Electrical Characteristics (T<sub>A</sub>=25°C unless otherwise noted) (Continue)**

Part Number		Reverse Stand-Off Voltage V <sub>RWM</sub> (V)	Breakdown Voltage V <sub>BR</sub> (V) @I <sub>T</sub>		Test Current I <sub>T</sub> (mA)	Maximum Clamping Voltage V <sub>C</sub> @I <sub>PP</sub> (V)	Maximum Peak Pulse Current I <sub>PP</sub> (A)	Maximum Reverse Leakage I <sub>R</sub> @V <sub>RWM</sub> (μA)
Uni	Bi		MIN	MAX				
1.5KE91	1.5KE91C	73.7	81.90	100.10	1	131.0	11.45	5
1.5KE91A	1.5KE91CA	77.8	86.45	95.55	1	125.0	12.00	5
1.5KE100	1.5KE100C	81.0	90.00	110.00	1	144.0	10.42	5
1.5KE100A	1.5KE100CA	85.5	95.00	105.00	1	137.0	10.95	5
1.5KE110	1.5KE110C	89.2	99.00	121.00	1	158.0	9.49	5
1.5KE110A	1.5KE110CA	94.0	104.50	115.50	1	152.0	9.87	5
1.5KE120	1.5KE120C	97.2	108.00	132.00	1	173.0	8.67	5
1.5KE120A	1.5KE120CA	102.0	114.00	126.00	1	165.0	9.09	5
1.5KE130	1.5KE130C	105.0	117.00	143.00	1	187.0	8.02	5
1.5KE130A	1.5KE130CA	111.0	123.50	136.50	1	179.0	8.38	5
1.5KE150	1.5KE150C	121.0	135.00	165.00	1	215.0	6.98	5
1.5KE150A	1.5KE150CA	128.0	142.50	157.50	1	207.0	7.25	5
1.5KE160	1.5KE160C	130.0	144.00	176.00	1	230.0	6.52	5
1.5KE160A	1.5KE160CA	136.0	152.00	168.00	1	219.0	6.85	5
1.5KE170	1.5KE170C	138.0	153.00	187.00	1	244.0	6.15	5
1.5KE170A	1.5KE170CA	145.0	161.50	178.50	1	234.0	6.41	5
1.5KE180	1.5KE180C	146.0	162.00	198.00	1	258.0	5.81	5
1.5KE180A	1.5KE180CA	154.0	171.00	189.00	1	246.0	6.10	5
1.5KE200	1.5KE200C	162.0	180.00	220.00	1	287.0	5.23	5
1.5KE200A	1.5KE200CA	171.0	190.00	210.00	1	274.0	5.47	5
1.5KE220	1.5KE220C	175.0	198.00	242.00	1	344.0	4.36	5
1.5KE220A	1.5KE220CA	185.0	209.00	231.00	1	328.0	4.57	5
1.5KE250	1.5KE250C	202.0	225.00	275.00	1	360.0	4.17	5
1.5KE250A	1.5KE250CA	214.0	237.50	262.50	1	344.0	4.36	5
1.5KE300	1.5KE300C	243.0	270.00	330.00	1	430.0	3.49	5
1.5KE300A	1.5KE300CA	256.0	285.00	315.00	1	414.0	3.62	5
1.5KE350	1.5KE350C	284.0	315.00	385.00	1	504.0	2.98	5
1.5KE350A	1.5KE350CA	299.3	332.50	367.50	1	482.0	3.11	5
1.5KE380	1.5KE380C	308.6	342.00	418.00	1	547.2	2.74	5
1.5KE380A	1.5KE380CA	324.9	361.00	399.00	1	524.4	2.86	5
1.5KE400	1.5KE400C	324.8	360.00	440.00	1	576.0	2.60	5
1.5KE400A	1.5KE400CA	342.0	380.00	420.00	1	552.0	2.72	5
1.5KE440	1.5KE440C	357.3	396.00	484.00	1	633.6	2.37	5
1.5KE440A	1.5KE440CA	376.2	418.00	462.00	1	607.2	2.47	5
1.5KE500	1.5KE500C	406.0	450.00	550.00	1	720.0	2.08	5
1.5KE500A	1.5KE500CA	427.5	475.00	525.00	1	690.0	2.17	5
1.5KE520	1.5KE520C	422.2	468.00	572.00	1	748.8	2.00	5
1.5KE520A	1.5KE520CA	444.6	494.00	546.00	1	717.6	2.09	5
1.5KE550	1.5KE550C	446.6	495.00	605.00	1	792.0	1.89	5
1.5KE550A	1.5KE550CA	470.3	522.50	577.50	1	759.0	1.98	5
1.5KE600	1.5KE600C	487.2	540.00	660.00	1	864.0	1.74	5
1.5KE600A	1.5KE600CA	513.0	570.00	630.00	1	828.0	1.81	5

**Note:**

1. Suffix 'A' denotes 5% tolerance device. Without 'A' denotes 10% tolerance device
2. Add suffix 'C' or 'CA' after part number to specify Bi-directional devices
3. For Bi-Directional devices having V<sub>R</sub> of 10 volts and under, the I<sub>R</sub> limit is double

# Axial Lead Transient Voltage Suppressors (TVS)

1.5KE Series 6.8 To 600 V 1500W

Ratings and Characteristic Curves ( $T_A=25^\circ\text{C}$  unless otherwise noted)

**Figure 1 - Peak Pulse Power Rating Curve**

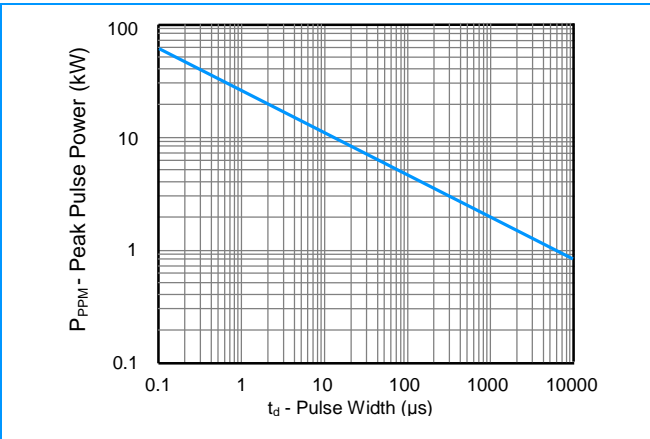

**Figure 2 - Pulse Derating Curve**

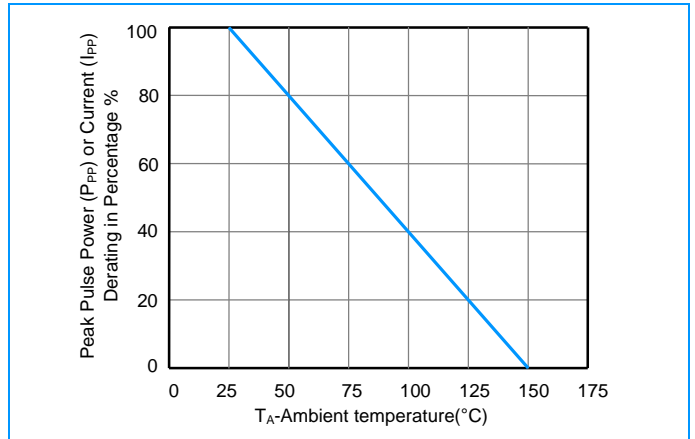

**Figure 3 - Pulse Waveform**

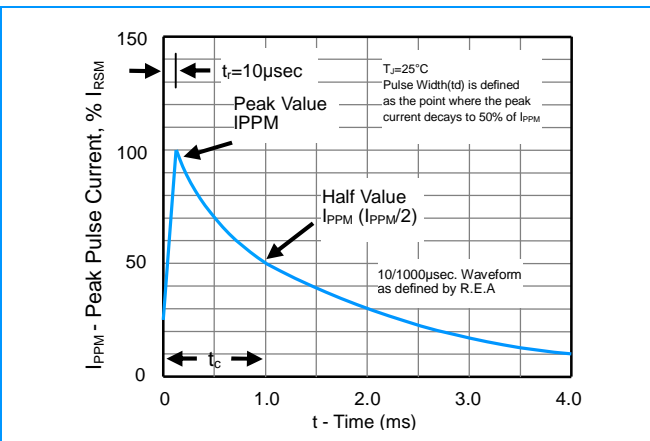

**Figure 4 - Typical Junction Capacitance**

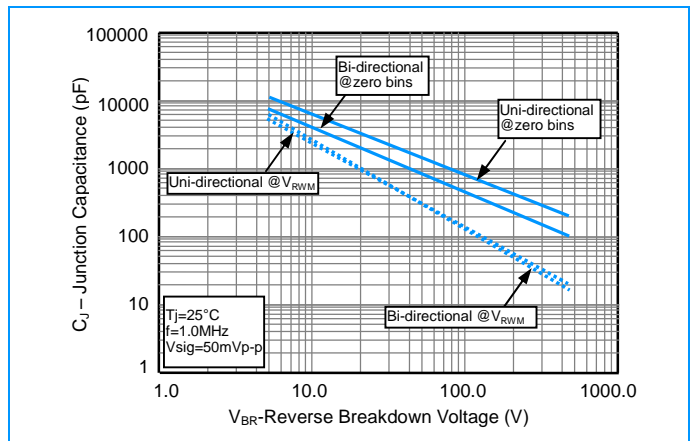

**Figure 5 - Steady State Power Derating Curve**

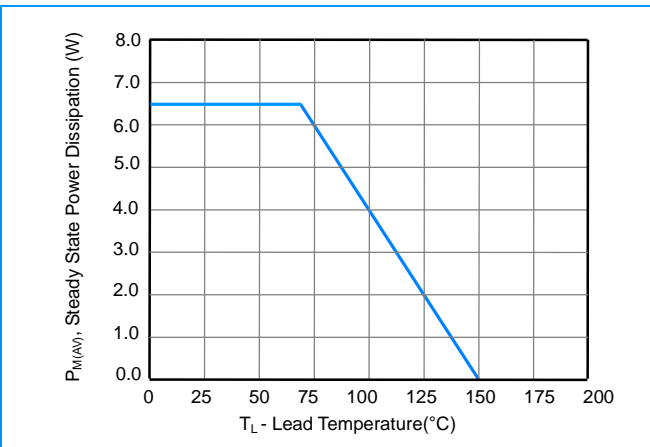

**Figure 6 - Maximum Non-Repetitive Surge Current**

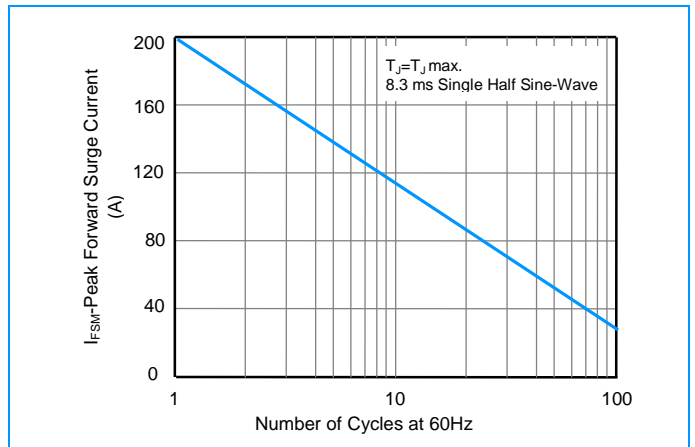

## Axial Lead Transient Voltage Suppressors (TVS)

**1.5KE Series 6.8 To 600 V 1500W**

### I-V Curve Characteristics

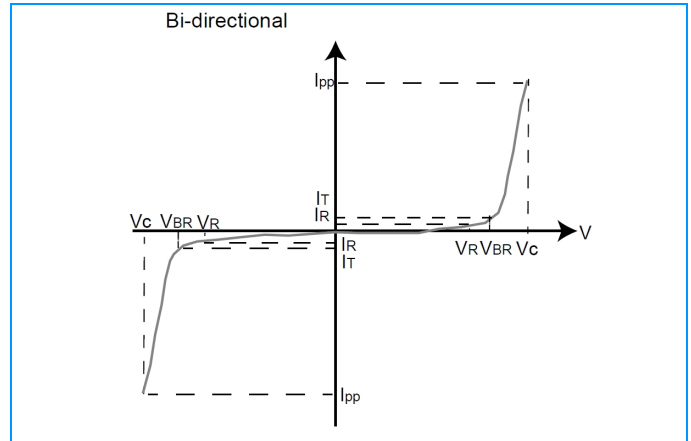
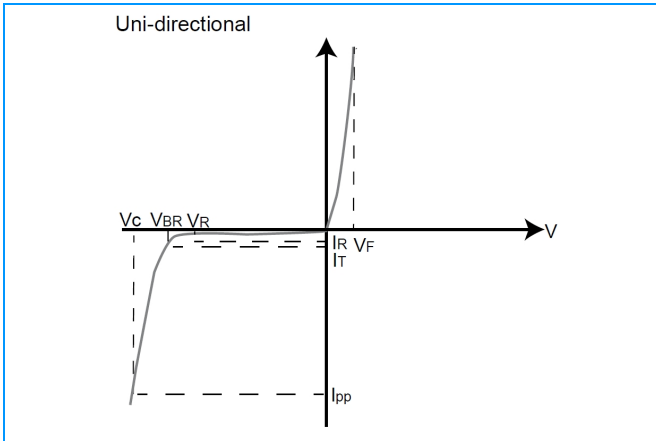

### Physical Specifications

<b>Weight</b>	0.032 ounce, 0.9 gram
<b>Case</b>	JEDEC DO-201 Molded Plastic over glass passivated junction
<b>Polarity</b>	Color band denotes cathode except Bipolar
<b>Terminal</b>	Matte Tin-plated leads, Solderable per JESD22-B102D

### Environmental Specifications

<b>Temperature Cycle</b>	JESD22-A104
<b>Pressure Cooker</b>	JESD22-A102
<b>High Temp. Storage</b>	JESD22-A103
<b>HTRB</b>	JESD22-A108
<b>Thermal Shock</b>	JESD22-A106

### Soldering Parameters

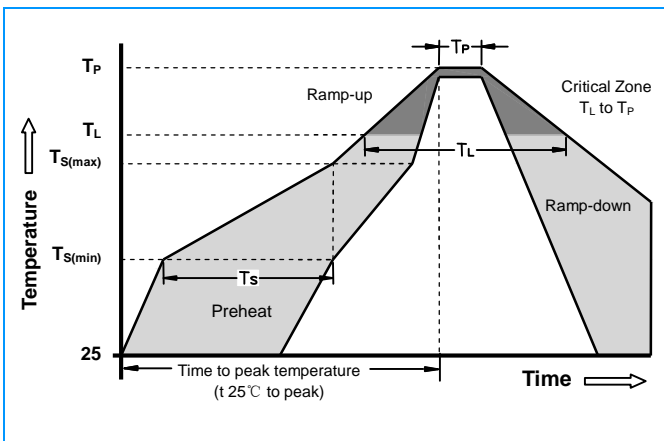

Reflow Condition		Lead-free assembly
Pre Heat	-Temperature Min ( $T_{s(min)}$ )	150°C
	-Temperature Max ( $T_{s(max)}$ )	200°C
	- Time (min to max) ( $t_s$ )	60 -180 Seconds
Average ramp up rate ( Liquidus Temp $T_L$ ) to peak		3°C/second max
$T_{s(max)}$ to $T_L$ - Ramp-up Rate		3°C/second max
Reflow	- Temperature ( $T_L$ ) (Liquidus)	217°C
	- Time (min to max) ( $t_s$ )	60 -150 Seconds
Peak Temperature ( $T_p$ )		260 +0/-5°C
Time within 5°C of actual peak Temperature ( $t_p$ )		20 -40 Seconds
Ramp-down Rate		6°C/second max
Time 25°C to peak Temperature ( $T_p$ )		8 minutes Max
Do not exceed		280°C

## Axial Lead Transient Voltage Suppressors (TVS)

1.5KE Series 6.8 To 600 V 1500W

### Dimensions

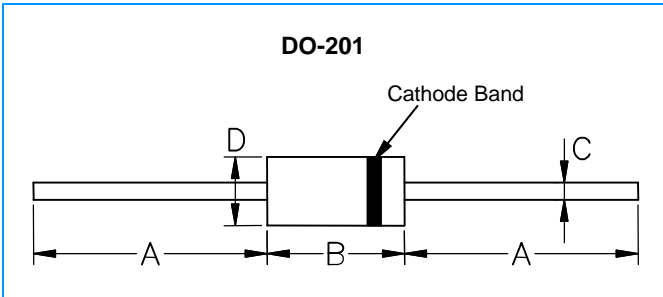

Dimensions	Inches		Millimeters	
	Min	Max	Min	Max
A	1.000	-	25.40	-
B	0.285	0.375	7.24	9.53
C	0.038	0.042	0.97	1.07
D	0.189	0.209	4.79	5.30

### Part Numbering

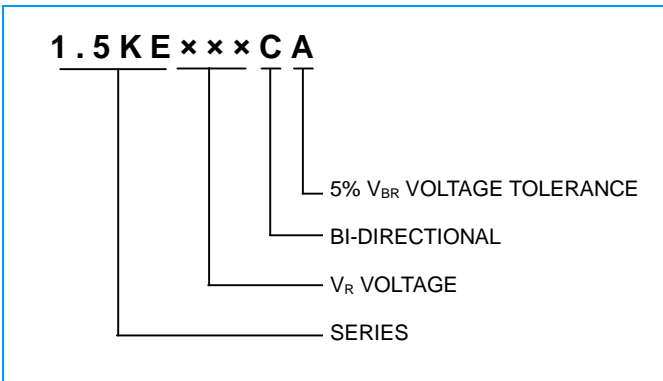

### Packaging

Part Number	Component Package	Quantity	Packaging Option
1.5KEXXXXX	DO-201	1000	Box

### Packaging Dimensions Unit: Inches (Millimeters)

