



Technical Data Sheet

Mini Top View LEDs

65-21UYC/S530-XX/TR8

Features

- White SMT package.
- Optical indicator.
- Wide viewing angle.
- Soldering methods: reflow soldering
- Available on tape and reel
- Pb-free
- The product itself will remain within RoHS compliant version.



Descriptions

- The 65-21 series is available in soft orange, green, blue, and yellow. Due to the package design, the LED has wide viewing angle and optimized light coupling by inter reflector. This feature makes the LED ideal for light pipe application.

Applications

- Optical indicators.
- Coupling into light guides.
- Backlighting (LCD, cellular phones, switches, keys, displays, illuminated advertising, general lighting).
- Coupling into light guides; Interior automotive lighting (e.g. dashboard backlighting, etc.).

Device Selection Guide

Chip	Emitted Color	Resin Color
Material		
AlGaInP	Brilliant Yellow	Water Clear

Technical Data Sheet

Mini Top View LEDs

65-21UYC/S530-XX/TR8

Package Outline Dimensions

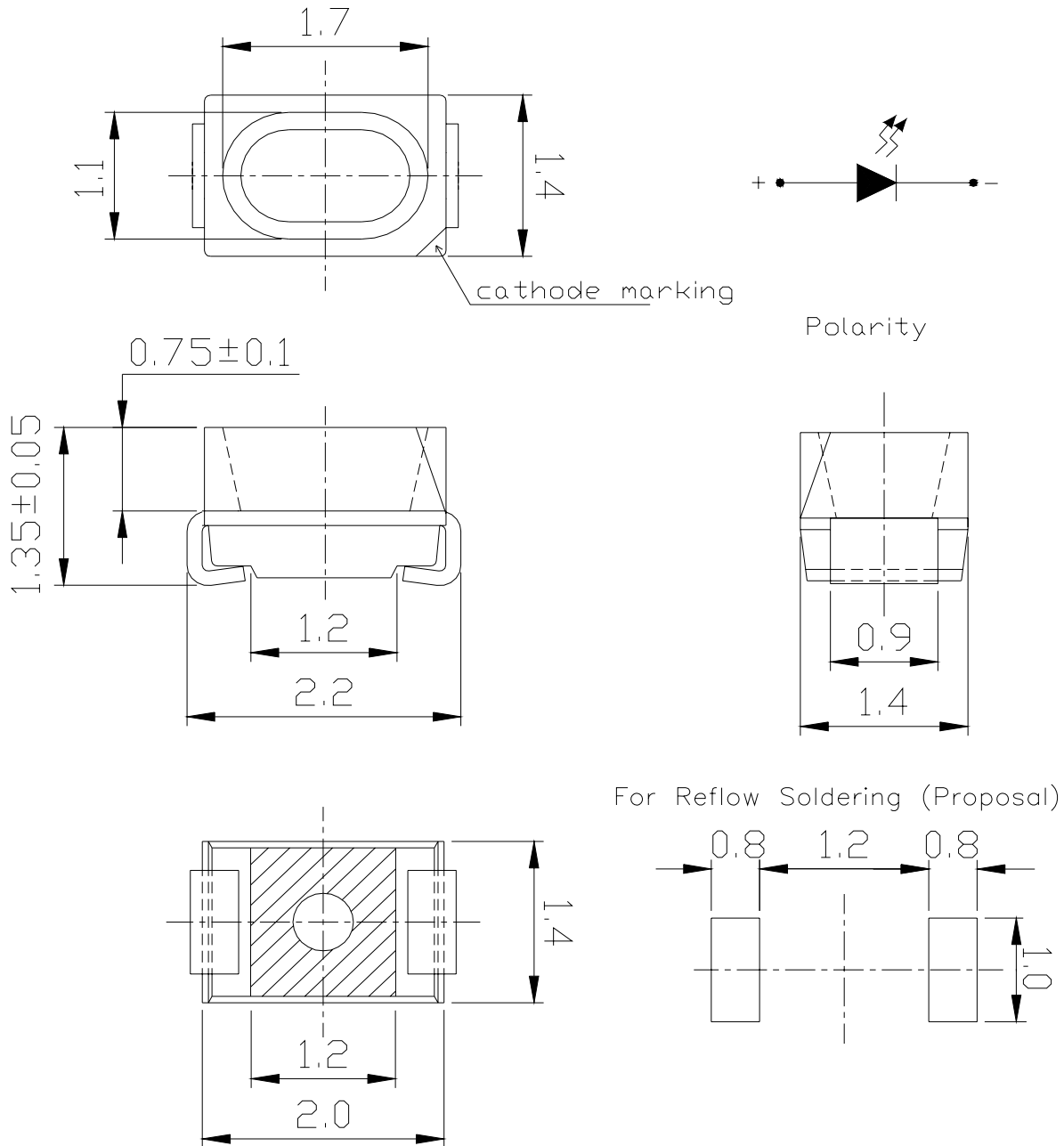

Note: The tolerances unless mentioned is ±0.1mm; Unit = mm

**Technical Data Sheet****Mini Top View LEDs****65-21UYC/S530-XX/TR8****Absolute Maximum Ratings (Ta=25°C)**

Parameter	Symbol	Rating	Unit
Reverse Voltage	V _R	5	V
Forward Current	I _F	25	mA
Operating Temperature	T _{opr}	-40 ~ +85	°C
Storage Temperature	T _{stg}	-40 ~ +90	°C
Electrostatic Discharge(HBM)	ESD	2000	V
Power Dissipation	P _d	60	mW
Peak Forward Current (Duty 1/10 @1KHz)	I _{FP}	60	mA
Soldering Temperature	T _{sol}	Reflow Soldering : 260 °C for 10 sec. Hand Soldering : 350 °C for 3 sec.	



Technical Data Sheet

Mini Top View LEDs

65-21UYC/S530-XX/TR8

Electro-Optical Characteristics (Ta=25°C)

Parameter	Symbol	Min.	Typ.	Max.	Unit	Condition
Luminous Intensity	I _v *	A3	40	68		mcd I _F =20mA
		A4	50	70	-----	
		A5	63	99	-----	
		A6	80	135	-----	
		A7	110	166	-----	
Viewing Angle	2θ 1/2	-----	120	-----	deg	I _F =20mA
Peak Wavelength	λ _p	-----	591	-----	nm	I _F =20mA
Dominant Wavelength	λ _d	-----	589	-----	nm	I _F =20mA
Spectrum Radiation Bandwidth	Δλ	-----	15	-----	nm	I _F =20mA
Forward Voltage	V _F	-----	2.0	2.4	V	I _F =20mA
Reverse Current	I _R	-----	-----	10	μA	V _R =5V

*65-21UYC/S530-XX/TR8

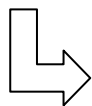

Chip Rank

Technical Data Sheet

Mini Top View LEDs

65-21UYC/S530-XX/TR8

Typical Electro-Optical Characteristics Curves

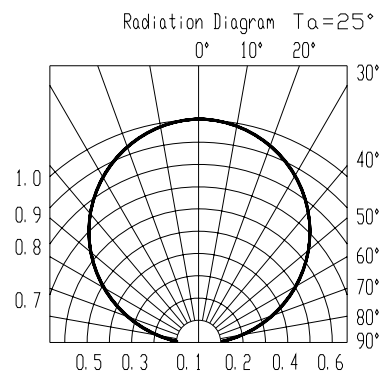
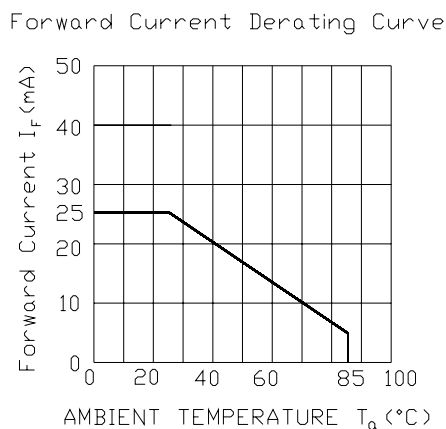
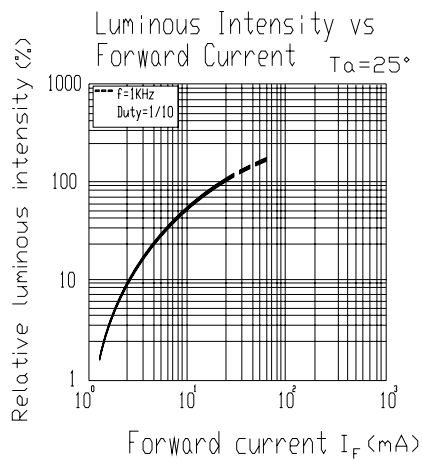
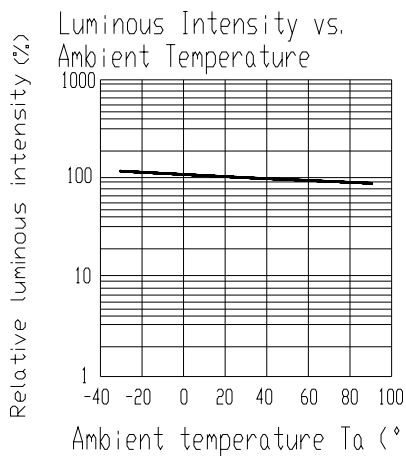
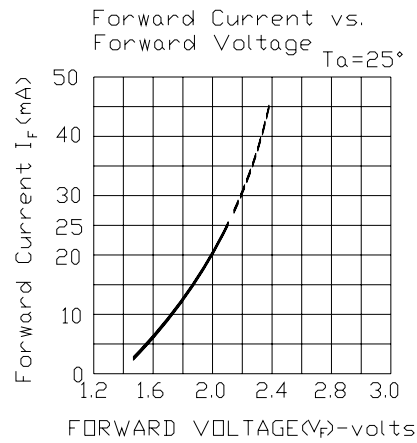
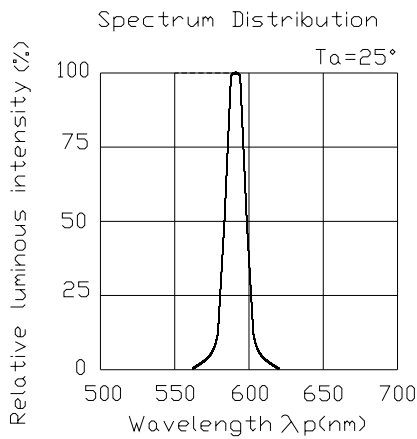



Technical Data Sheet

Mini Top View LEDs

65-21UYC/S530-XX/TR8

Label Explanation

CAT: Luminous Intensity Rank

HUE: Dom. Wavelength Rank

REF: Forward Voltage Rank

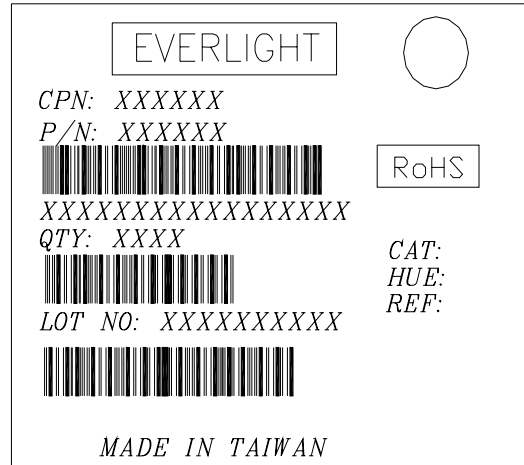

Reel Dimensions

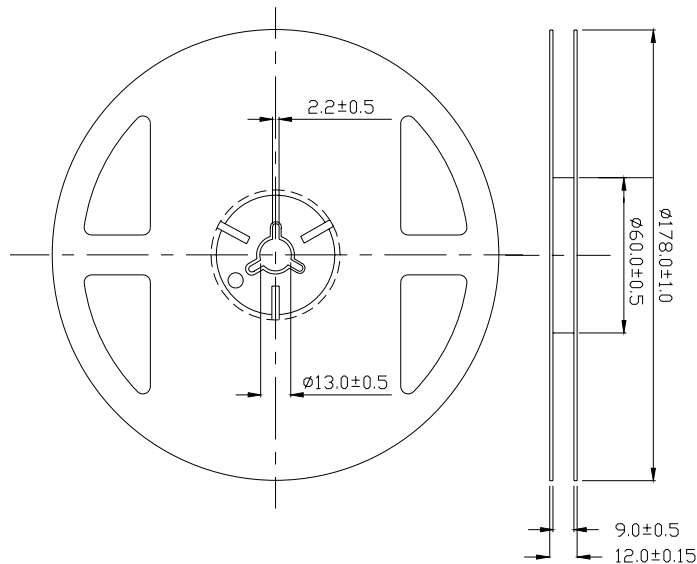

Note: Tolerance unless mentioned is ±0.1mm; Unit = mm

Technical Data Sheet

Mini Top View LEDs

65-21UYC/S530-XX/TR8

Carrier Tape Dimensions

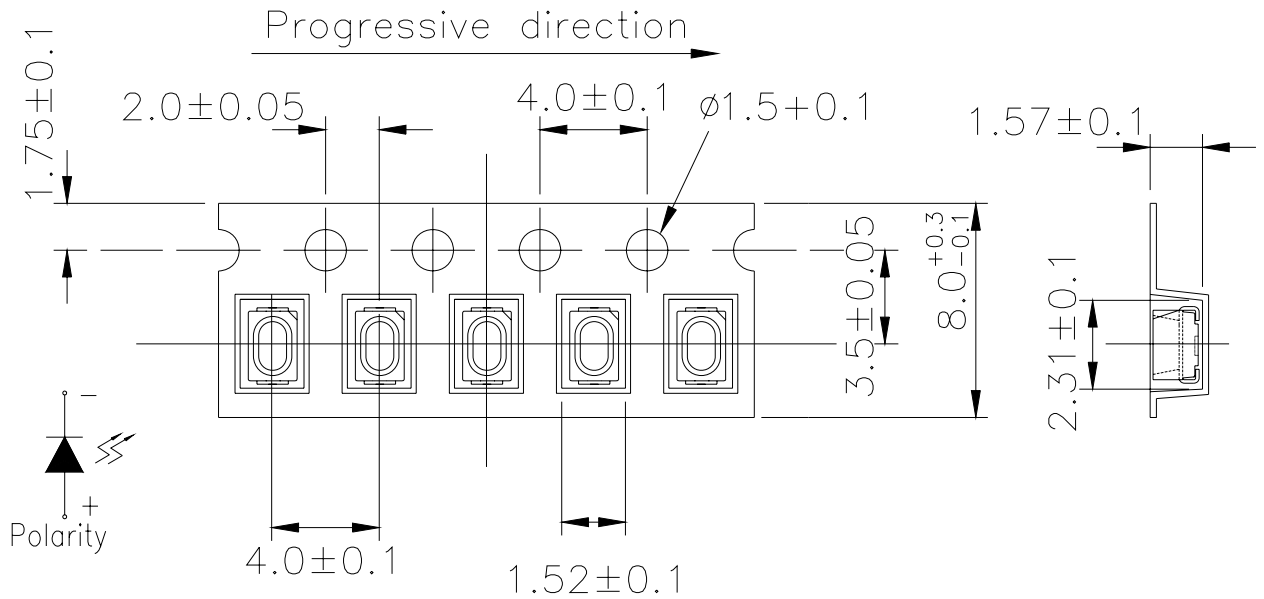

Note: Tolerance unless mentioned is $\pm 0.1\text{mm}$; Unit = mm

Moisture Resistant Packaging

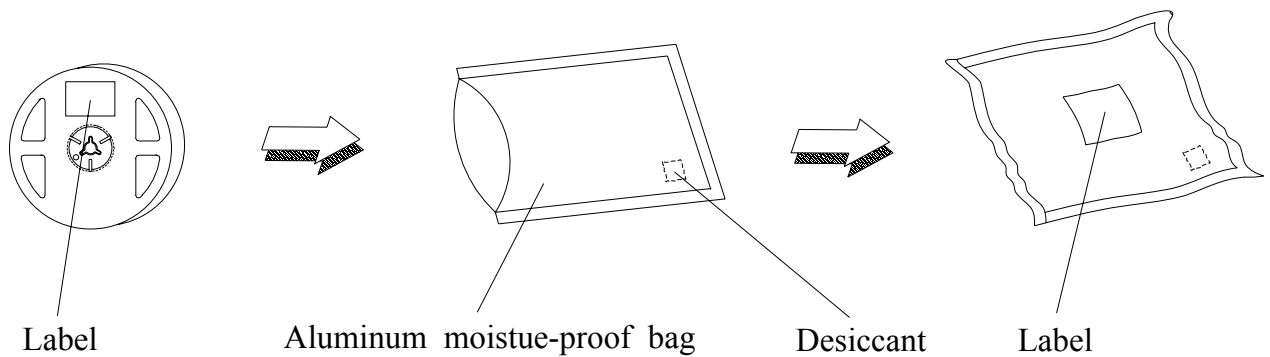

**Technical Data Sheet****Mini Top View LEDs****65-21UYC/S530-XX/TR8****Reliability Test Items and Conditions**

The reliability of products shall be satisfied with items listed below.

Confidence level : 90%

LTPD : 10%

No.	Items	Test Condition	Test Hours/Cycles	Sample Size	Ac/Re
1	Reflow Soldering	Temp. : 260°C±5°C Min. 5sec.	6 Min.	22 PCS.	0/1
2	Temperature Cycle	H : +100°C 15min ∫ 5 min L : -40°C 15min	300 Cycles	22 PCS.	0/1
3	Thermal Shock	H : +100°C 5min ∫ 10 sec L : -10°C 5min	300 Cycles	22 PCS.	0/1
4	High Temperature Storage	Temp. : 100°C	1000 Hrs.	22 PCS.	0/1
5	Low Temperature Storage	Temp. : -40°C	1000 Hrs.	22 PCS.	0/1
6	DC Operating Life	I _F = 20 mA	1000 Hrs.	22 PCS.	0/1
7	High Temperature / High Humidity	85°C / 85%RH	1000 Hrs.	22 PCS.	0/1

Technical Data Sheet**Mini Top View LEDs****65-21UYC/S530-XX/TR8****Precautions for Use**

1. Over-current-proof

Customer must apply resistors for protection, otherwise slight voltage shift will cause big current change (Burn out will happen).

2. Storage

2.1 Do not open moisture proof bag before the products are ready to use.

2.2 Before opening the package: The LEDs should be kept at 30°C or less and 90%RH or less.

2.3 After opening the package: The LED's floor life is 1 year under 30 deg C or less and 60% RH or less. If unused LEDs remain, it should be stored in moisture proof packages.

2.4 If the moisture absorbent material (silica gel) has faded away or the LEDs have exceeded the storage time, baking treatment should be performed using the following conditions.

Baking treatment : 60±5°C for 24 hours.

3. Soldering Condition

3.1 Pb-free solder temperature profile

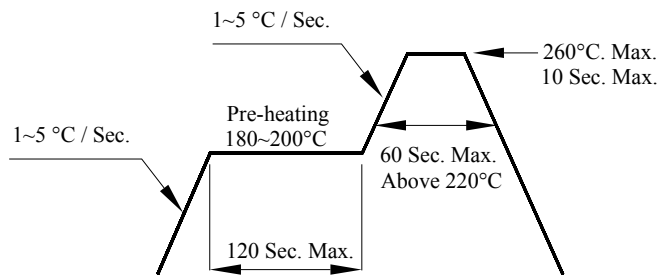

3.2 Reflow soldering should not be done more than two times.

3.3 When soldering, do not put stress on the LEDs during heating.

3.4 After soldering, do not warp the circuit board.

Technical Data Sheet**Mini Top View LEDs****65-21UYC/S530-XX/TR8****4. Soldering Iron**

Each terminal is to go to the tip of soldering iron temperature less than 350°C for 3 seconds within once in less than the soldering iron capacity 25W. Leave two seconds and more intervals, and do soldering of each terminal. Be careful because the damage of the product is often started at the time of the hand solder.

5. Repairing

Repair should not be done after the LEDs have been soldered. When repairing is unavoidable, a double-head soldering iron should be used (as below figure). It should be confirmed beforehand whether the characteristics of the LEDs will or will not be damaged by repairing.

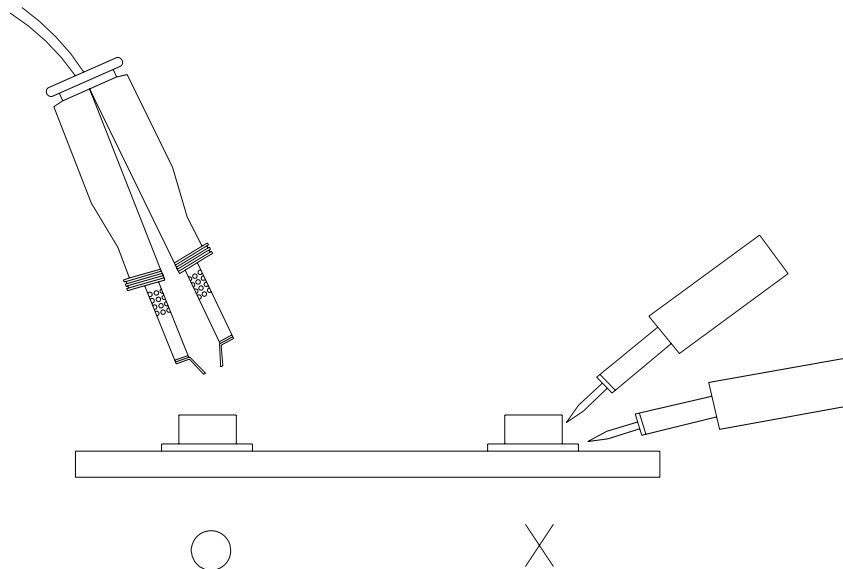

EVERLIGHT ELECTRONICS CO., LTD.
Office: No 25, Lane 76, Sec 3, Chung Yang Rd,
Tucheng, Taipei 236, Taiwan, R.O.C

Tel: 886-2-2267-2000, 2267-9936
Fax: 886-2267-6244, 2267-6189, 2267-6306
<http://www.everlight.com>