

ComPAC™

DC-DC Switchers 50 to 600W 1-3 Outputs



Product Highlights

ComPAC delivers up to 600W from one, two, or three outputs in a package just 0.99" (25,2mm) in height with the field proven performance, high efficiency and high reliability inherent in Vicor's component level power converters. ComPAC meets British Telecom and European norms for input surge withstand and meets conducted emissions of EN55022 Class B. ComPAC is offered with input voltage ranges optimized for industrial and telecommunication applications and provides extended input overvoltage capability, input reverse polarity protection, undervoltage lockout, and master disable.

Use the configuration chart at the right to define your Vicor part number(s).

Conduction Cooled Models Available
Add "-CC" to the end of the part number.
(Consult factory for details.)

Features

- Inputs 24, 48, and 300Vdc
- Any output: 1 to 95Vdc
- Input surge withstand: British Telecom BTR 2511, EN-61000-4-5
- Meets British Telecom BTR 2511, EN55022 Class B conducted emissions
- UL, CSA, TÜV (IEC 950)
- CE marked
- 80-90% efficiency
- Up to 10W/cubic inch
- Reverse polarity protected
- Master disable
- Overvoltage shutdown

ComPAC Configuration Chart

	Total Power	Part No.	Dimensions
Single Outputs:	50-200W	VI-LC	8.6" x 2.5" x 0.99" (218,4 x 63,5 x 25,2mm)
	100-400W	VI-MC	8.6" x 4.9" x 0.99" (218,4 x 124,5 x 25,2mm)
	300-600W	VI-NC	8.6" x 7.3" x 0.99" (218,4 x 185,4 x 25,2mm)
Dual Outputs:	100-400W	VI-PC	8.6" x 4.9" x 0.99" (218,4 x 124,5 x 25,2mm)
	150-600W	VI-QC	8.6" x 7.3" x 0.99" (218,4 x 185,4 x 25,2mm)
Triple Outputs:	150-600W	VI-RC	8.6" x 7.3" x 0.99" (218,4 x 185,4 x 25,2mm)

<p>Input Voltage </p> <p>Nominal Range</p> <p>1 = 24V 21 - 32V (1) W = 24V 18 - 36V (1) 3 = 48V 42 - 60V (2) N = 48V 36 - 76V (2) 6 = 300V 200 - 400V (2)</p>	<p>Output Voltage </p> <p>Z 2V M 10V K 40V Y 3.3V 1 12V 4 48V O 5V P 13.8V H 52V X 5.2V 2 15V F 72V W 5.5V N 18.5V D 85V V 5.8V 3 24V B 95V T 6.5V L 28V R 7.5V J 36V</p>	<p>Product Grade </p> <p>E = -10°C to +85°C C = -25°C to +85°C I = -40°C to +85°C M = -55°C to +85°C</p>	<p>Output Power/Current </p> <p>$V_{out} \geq 5V$ $V_{out} < 5V$ Y = 50W 10A X = 75W 15A W = 100W 20A V = 150W 30A U = 200W 40A</p>									
<table border="1"> <tr> <th>Max output for</th> <th>$\geq 5V$ Outputs</th> <th>$< 5V$ Outputs</th> </tr> <tr> <td>(1)</td> <td>150W</td> <td>30A</td> </tr> <tr> <td>(2)</td> <td>200W</td> <td>40A</td> </tr> </table>	Max output for	$\geq 5V$ Outputs	$< 5V$ Outputs	(1)	150W	30A	(2)	200W	40A		<p>Output Power/Current </p> <p>$V_{out} \geq 5V$ $V_{out} < 5V$ W = 100W 20A V = 150W 30A U = 200W 40A S = 300W 60A Q = 400W 80A</p>	<p>Output Power/Current </p> <p>$V_{out} \geq 5V$ $V_{out} < 5V$ S = 300W 60A P = 450W 90A M = 600W 120A</p>
Max output for	$\geq 5V$ Outputs	$< 5V$ Outputs										
(1)	150W	30A										
(2)	200W	40A										

Long Term Safe Operating Area Curves (1% duty cycle max. $Z_s=0.5\Omega$; for short duration transient capability refer to page 3.)

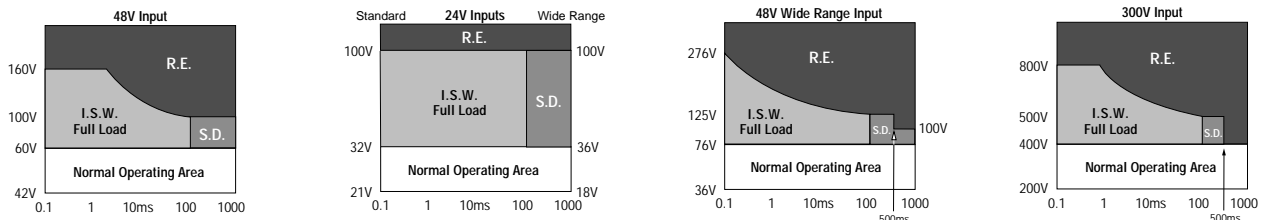

I.S.W.: Input surge withstand, no degradation of performance. R.E.: Ratings Exceeded S.D.: Shutdown

ComPAC Specifications

(Typical at 25°C, nominal line and 75% load, unless otherwise specified)

PARAMETER	E-GRADE			C-, I-, M-GRADE			BROWNOUT*	TRANSIENT**	UNITS	NOTES
	MIN	TYP	MAX	MIN	TYP	MAX				
Input Characteristics										
24V	21	24	32	21	24	32	18	36	Vdc	See Fusing Information below
24V Wide	18	24	36	18	24	36	n/a	n/a	Vdc	See Fusing Information below
48V	42	48	60	42	48	60	36	72	Vdc	See Fusing Information below
48V Wide	36	48	76	36	48	76	n/a	n/a	Vdc	See Fusing Information below
300V	200	300	400	200	300	400	170	425	Vdc	See Fusing Information below
No load power dissipation ³	1.35		2	1.35		2			Watts	
Master disable input current ³ (Absolute max., 20 mA)	4			4					mA	Sink or source into disable optocoupler
Quiescent Input current logic disable ³		7	10		7	10			mA	Current drawn from source when disabled
Reverse polarity protection										No damage to unit with external fuse
Output Characteristics (applies to each output individually)										
Setpoint accuracy		1%	2%		0.5%	1%			V _{NOM}	
Load/line regulation			0.5%		0.05%	0.2%			V _{NOM}	LL to HL, 10% to full load
Load/line regulation			1%		0.2%	0.5%			V _{NOM}	LL to HL, no load to full load
Output temperature drift		0.02			0.01	0.02			%/°C	Over rated temperature
Long term drift		0.02			0.02				%/1k hours	
Output ripple										
2V, 3.3V			150mV		60mV	100mV			Vp-p	20 MHz bandwidth
5V			5%		2%	3%			Vp-p	20 MHz bandwidth
10-48V			3%		0.75%	1.5%			Vp-p	20 MHz bandwidth
Output voltage trimming ¹	50%		110%	50%		110%				
Total remote sense compensation ¹	0.5			0.5					Volts	0.25V max. neg. leg
OVP set point		125%		115%	125%	135%			V _{NOM}	Recycle power
Current limit	105%		135%	105%		125%			I _{NOM}	Automatic restart
Short circuit current ²	20%		140%	20%		130%			I _{NOM}	
Thermal Characteristics										
Efficiency		78-88%		80-90%						@5V and higher
Shutdown temp. — case	90	95	105	90	95	105			°C	Cool and recycle power to restart
Operating temp. — case			85			85			°C	See Thermal Curves
Isolation Characteristics										
Isolation										
Input to output	4,242			4,242					Vdc	
Output to case	707			707					Vdc	
Input to case	2,121			2,121					Vdc	
Mechanical Specifications										
Weight ³		19.2 (544)		19.2 (544)						Ounces (Grams)
Fusing Information										
Input voltage		24V	48V	300V						
LC series (200W)		10A	7A	2A						
MC, PC series (400W)		20A	15A	4A						
NC, QC, RC series (600W)		35A	25A	6A						
Safety Agency Approvals										
UL, CSA, TÜV, VDE, IEC 950, CE Marked										
Environmental Characteristics/Product Grade Designators (Temperatures apply to product case.)										
		E-Grade	C-Grade	I-Grade	M-Grade					
Storage temperature		-20°C to +100°C	-40°C to +100°C	-55°C to +100°C	-65°C to +100°C					
Operating temperature		-10°C to +85°C	-25°C to +85°C	-40°C to +85°C	-55°C to +85°C					
EMI / EMC Characteristics (Performed on selected samples representative of the ComPac product family.)										
Input surge withstand	(Up to 200 mS, Z _s = .5Ω, no interruption of performance, see: Long Term Safe Operating Area Curves, pg.2)									
	IEC 61000-4-5 level 2									
Conducted Emissions	British Telecom BTR 2511, Issue 2									
	EN 55022, class B									
ESD	IEC 61000-4-2 level 4									

*Brownout 75% of rated load.

**Transient voltage for one second.

¹10V, 12V and 15V outputs, trim range ± 10%. Consult factory for wider trim range.

²Output voltages of 5V or less incorporate foldback current limiting, outputs greater than 5V incorporate straight line current limiting.

³For MC, PC series, multiply by 2; for NC, QC, RC series, multiply by 3.

Thermal Curves, 5V Output (standard heatsink)

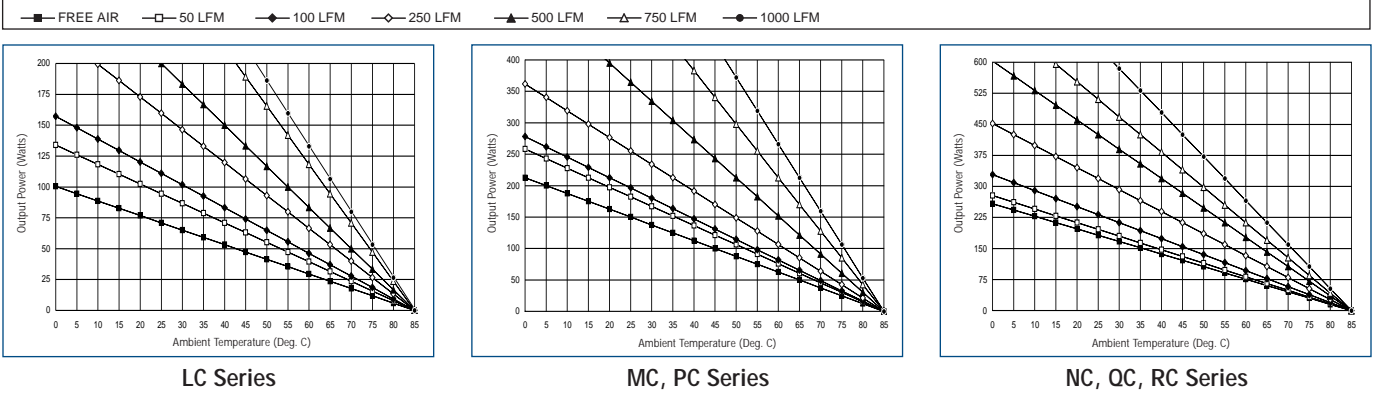

Thermal Curves, 10V to 48V Output (standard heatsink)

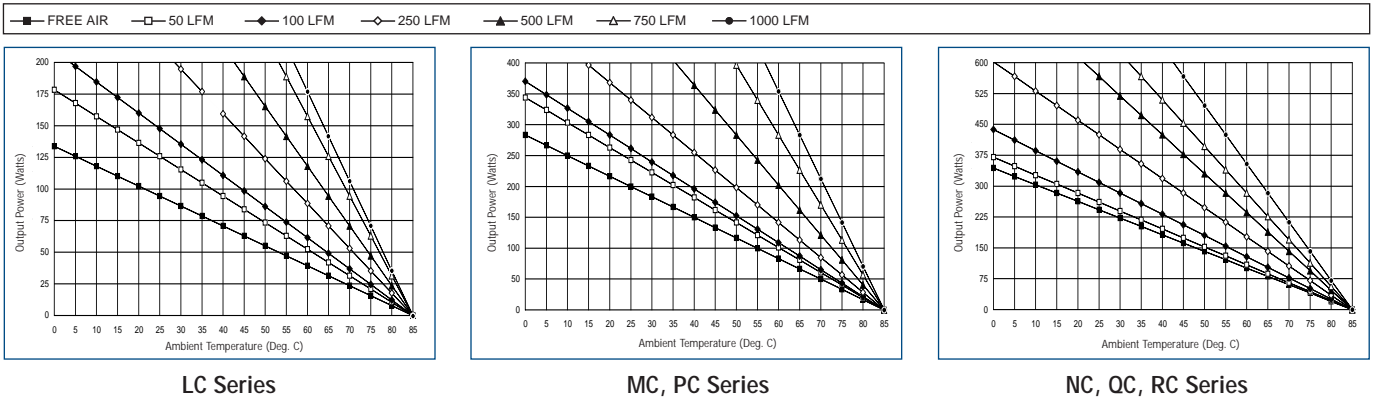

Thermal Curves, 5V Output (H1 heatsink)

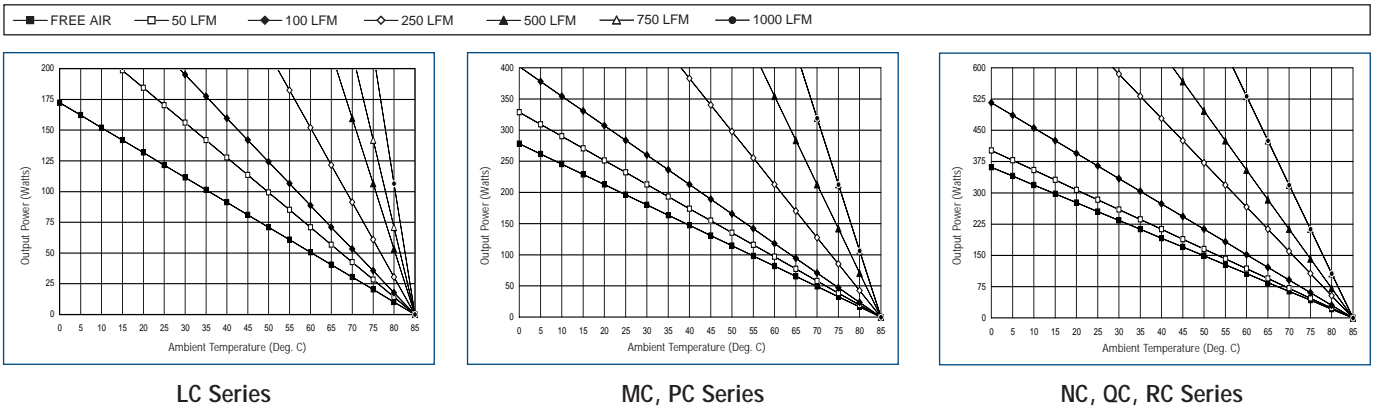

Thermal Curves, 10 to 48V Output (H1 heatsink)

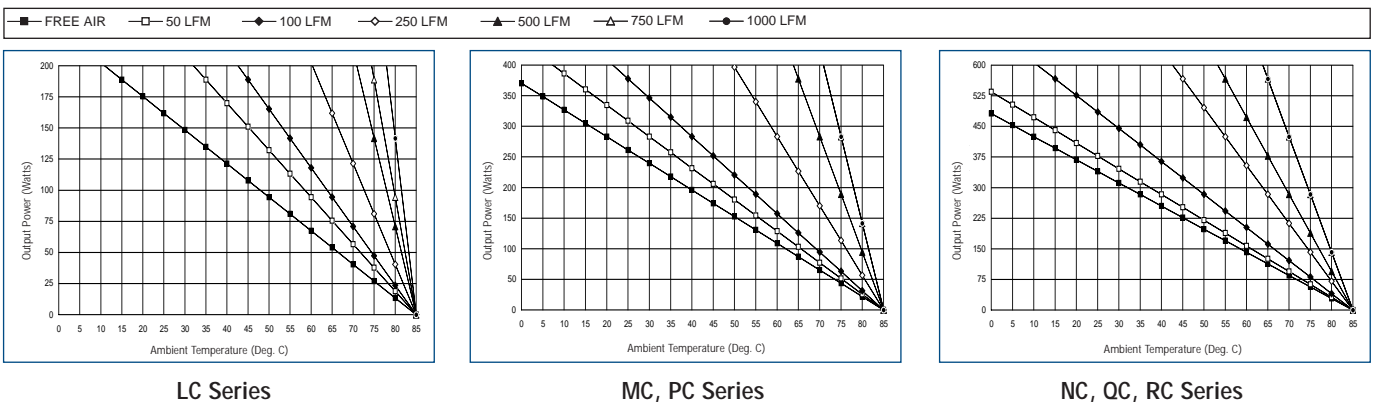

Mechanical Drawings

All Models

INPUTS	
1	Ground
2	-Input
3	+Input
4	Disable-
5	Disable+
OUTPUTS	
A	+Output
B	+Sense
C	Trim
D	-Sense
E	-Output

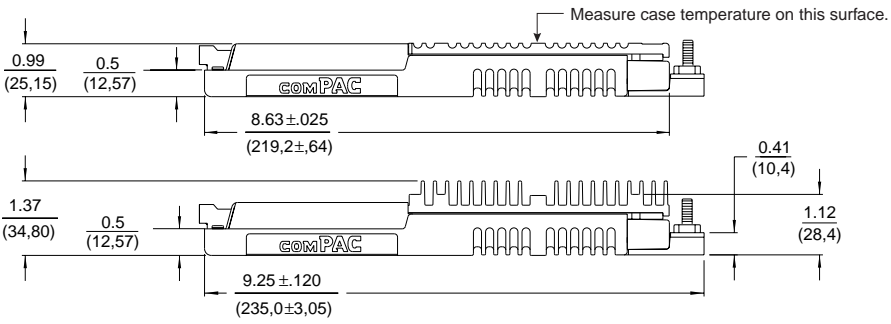

LC Series

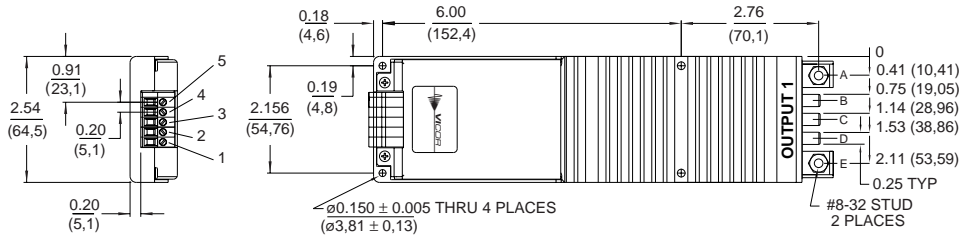

MC, PC Series

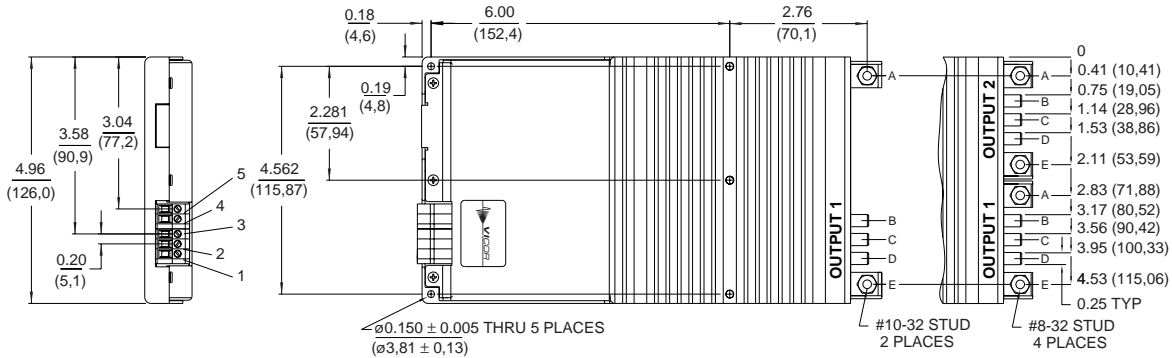

NC, QC, RC Series

