

# LP2980-ADJEP

## Micropower SOT, 50 mA Ultra Low-Dropout Adjustable Voltage Regulator

### General Description

The LP2980-ADJEP is a 50 mA adjustable voltage regulator designed to provide ultra low dropout in battery powered applications.

Using an optimized VIP® (vertically Integrated PNP) process, the LP2980-ADJEP delivers unequalled performance in all specifications critical to battery-powered designs:

**Adjustable Output:** output voltage can be set from 1.23V to 15V.

**Precision Reference:** 0.75% tolerance.

**Dropout Voltage:** typically 120 mV @ 50 mA load, and 7 mV @ 1 mA load.

**Ground Pin Current:** typically 320 µA @ 50 mA load, and 80 µA @ 1 mA load.

**Sleep Mode:** less than 1 µA quiescent current when on/off pin is pulled low.

**Smallest Possible Size:** SOT-23 package uses minimum board space.

#### ENHANCED PLASTIC

- Extended Temperature Performance of -40°C to +125°C
- Baseline Control - Single Fab & Assembly Site
- Process Change Notification (PCN)
- Qualification & Reliability Data
- Solder (PbSn) Lead Finish is standard
- Enhanced Diminishing Manufacturing Sources (DMS) Support

### Features

- Ultra low dropout voltage
- Output adjusts from 1.23V to 15V
- Guaranteed 50 mA output current
- Uses tiny SOT-23 package
- Requires few external components
- <1 µA quiescent current when shutdown
- Low ground pin current at all loads
- High peak current capability (150 mA typical)
- Wide supply voltage range (2.5V–16V)
- Overtemperature/overcurrent protection

### Applications

- Selected Military Applications
- Selected Avionics Applications

### Order Information

PART NUMBER	VID PART NUMBER	NS PACKAGE NUMBER (Note 3)
LP2980IM5-ADJEP	V62/07601-01XA	MF05A
(Notes 1, 2)	TBD	TBD

**Note 1:** For the following (Enhanced Plastic) version, check for availability: LP2980IM5XADJEP

**Note 2:** FOR ADDITIONAL ORDERING AND PRODUCT INFORMATION, PLEASE VISIT THE ENHANCED PLASTIC WEB SITE AT: [www.national.com/mil](http://www.national.com/mil)

**Note 3:** Refer to package details under Physical Dimensions

## Connection Diagram

5-Lead Small Outline Package (M5)

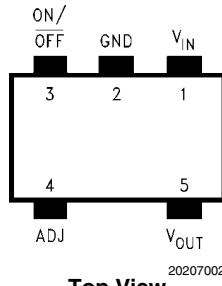

**Top View**  
See NS Package Number MF05A

## Block Diagram

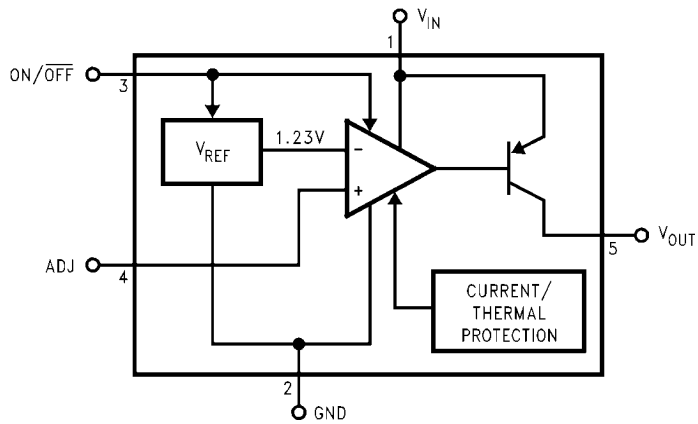

## Basic Application Circuit

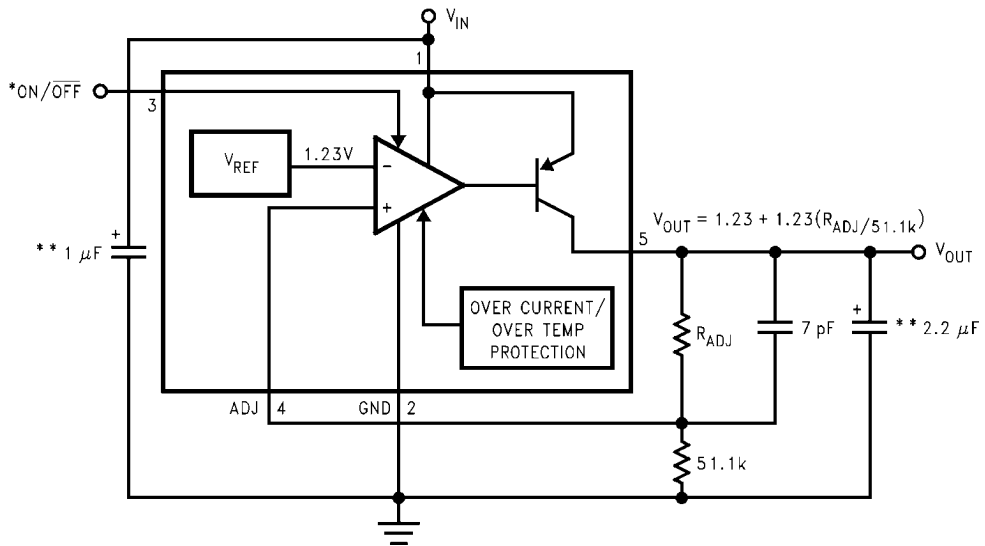

\*ON/OFF INPUT MUST BE ACTIVELY TERMINATED. TIE TO VIN IF THIS FUNCTION IS NOT TO BE USED.

\*\*MINIMUM CAPACITANCE IS SHOWN TO ENSURE STABILITY OVER FULL LOAD CURRENT RANGE (SEE APPLICATION HINTS).

## Absolute Maximum Ratings (Note 4)

If Military/Aerospace specified devices are required, please contact the National Semiconductor Sales Office/Distributors for availability and specifications.

Storage Temperature Range	-65 to +150°C
Operating Junction Temperature Range	-40 to +125°C
Lead Temp. (Soldering, 5 seconds)	260°C
ESD Rating (Note 5)	2 kV

Power Dissipation (Note 6)

Input Supply Voltage (Survival)	-0.3V to +16V
Input Supply Voltage (Operating)	2.5V to +16V
Shutdown Input Voltage (Survival)	-0.3V to +16V
Output Voltage (Survival) (Note 7)	-0.3V to 16V
I <sub>OUT</sub> (Survival)	Short Circuit Protected
Input-Output Voltage (Survival) (Note 8)	-0.3V to 16V

Internally Limited

## Electrical Characteristics (Note 13)

Limits in standard typeface are for T<sub>J</sub> = 25°C, and limits in **boldface type** apply over the full operating temperature range. Unless otherwise specified: V<sub>IN</sub> = 4.3V, V<sub>OUT</sub> = 3.3V, I<sub>L</sub> = 1 mA, C<sub>IN</sub> = 1 μF, C<sub>OUT</sub> = 2.2 μF, V<sub>ON/OFF</sub> = 2V.

Symbol	Parameter	Conditions	Typ	LP2980I-ADJEP (Note 9)		Units
				Min	Max	
V <sub>REF</sub>	Reference Voltage		1.225	1.213	1.237	V
		1 mA < I <sub>L</sub> < 50 mA V <sub>OUT</sub> + 1 ≤ V <sub>IN</sub> ≤ 16V	1.225	1.206 <b>1.182</b>	1.243 <b>1.268</b>	
$\frac{\Delta V_{REF}}{\Delta V_{IN}}$	Reference Voltage Line Regulation	2.5V ≤ V <sub>IN</sub> ≤ 16V	3		6.0 <b>15.0</b>	mV
V <sub>IN</sub> -V <sub>O</sub>	Dropout Voltage (Note 10)	I <sub>L</sub> = 0	1		3 <b>5</b>	mV
		I <sub>L</sub> = 1 mA	7		10 <b>15</b>	
		I <sub>L</sub> = 10 mA	40		60 <b>90</b>	
		I <sub>L</sub> = 50 mA	120		150 <b>225</b>	
I <sub>GND</sub>	Ground Pin Current	I <sub>L</sub> = 0	60		95 <b>125</b>	μA
		I <sub>L</sub> = 1 mA	80		110 <b>170</b>	
		I <sub>L</sub> = 10 mA	120		220 <b>460</b>	
		I <sub>L</sub> = 50 mA	320		600 <b>1200</b>	
		V <sub>ON/OFF</sub> < 0.18V	0.01		<b>1</b>	
I <sub>ADJ</sub>	ADJ Pin Bias Current	1 mA ≤ I <sub>L</sub> ≤ 50 mA	150		350	nA
V <sub>ON/OFF</sub>	ON/OFF Input Voltage (Note 11)	High = O/P ON	1.4	<b>1.6</b>		V
		Low = O/P OFF	0.55		<b>0.18</b>	
I <sub>ON/OFF</sub>	ON/OFF Input Current	V <sub>ON/OFF</sub> = 0	0.01		<b>-1</b>	μA
		V <sub>ON/OFF</sub> = 5V	5		<b>15</b>	
I <sub>O(PK)</sub>	Peak Output Current	V <sub>OUT</sub> ≥ V <sub>O(NOM)</sub> - 5%	150	100		mA
e <sub>n</sub>	Output Noise Voltage (RMS)	BW = 300 Hz to 50 kHz, C <sub>OUT</sub> = 10 μF	160			μV
$\frac{\Delta V_{OUT}}{\Delta V_{IN}}$	Ripple Rejection	f = 1 kHz C <sub>OUT</sub> = 10 μF	68			dB
I <sub>O(MAX)</sub>	Short Circuit Current	R <sub>L</sub> = 0 (Steady State) (Note 12)	150			mA

**Note 4:** Absolute maximum ratings indicate limits beyond which damage to the component may occur. Electrical specifications do not apply when operating the device outside of its rated operating conditions.

**Note 5:** The ESD rating of pins 3 and 4 is 1 kV.

**Note 6:** The maximum allowable power dissipation is a function of the maximum junction temperature,  $T_J(\text{MAX})$ , the junction-to-ambient thermal resistance,  $\theta_{J-A}$ , and the ambient temperature,  $T_A$ . The maximum allowable power dissipation at any ambient temperature is calculated using:

$$P(\text{MAX}) = \frac{T_J(\text{MAX}) - T_A}{\theta_{J-A}}$$

The value of  $\theta_{J-A}$  for the SOT-23 package is 300°C/W. Exceeding the maximum allowable power dissipation will cause excessive die temperature, and the regulator will go into thermal shutdown.

**Note 7:** If used in a dual-supply system where the regulator load is returned to a negative supply, the LP2980-ADJEP output must be diode-clamped to ground.

**Note 8:** The output PNP structure contains a diode between the  $V_{IN}$  and  $V_{OUT}$  terminals that is normally reverse-biased. Reversing the polarity from  $V_{IN}$  to  $V_{OUT}$  will turn on this diode (see Application Hints).

**Note 9:** Limits are 100% production tested at 25°C. Limits over the operating temperature range are guaranteed through correlation using Statistical Quality Control (SQC) methods. The limits are used to calculate National's Average Outgoing Quality Level (AOQL).

**Note 10:** Dropout voltage is defined as the input to output differential at which the output voltage drops 100 mV below the value measured with a 1V differential.

**Note 11:** The ON/OFF input must be properly driven to prevent possible misoperation. For details, refer to Application Hints.

**Note 12:** See Typical Performance Characteristics curves.

**Note 13:** Testing and other quality control techniques are used to the extent deemed necessary to ensure product performance over the specified temperature range. Product may not necessarily be tested across the full temperature range and all parameters may not necessarily be tested. In the absence of specific PARAMETRIC testing, product performance is assured by characterization and/or design.

**Typical Performance Characteristics** Unless otherwise specified:  $T_A = 25^\circ\text{C}$ ,  $V_{IN} = V_O(\text{NOM}) + 1\text{V}$ ,  $I_L = 1\text{ mA}$ , ON/OFF pin tied to  $V_{IN}$ ,  $R_{\text{ADJ}} = 86.6\text{ k}\Omega$ , and test circuit is as shown in Basic Application Circuit.

**Output Voltage vs. Temperature**

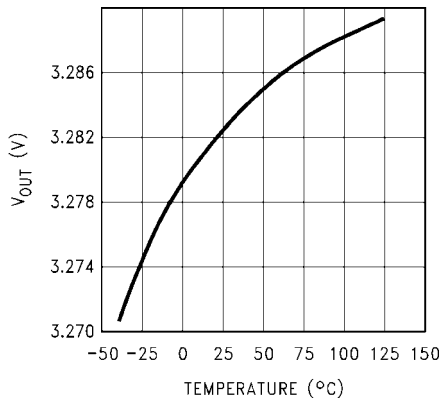

20207005

**Dropout Characteristics**

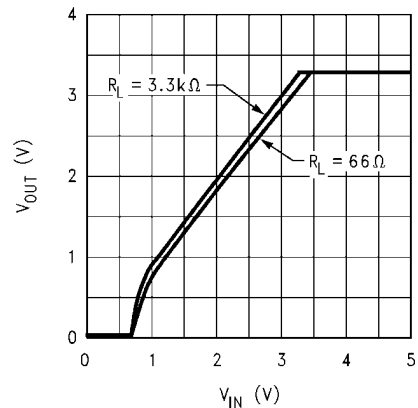

20207006

**Dropout Voltage vs. Temperature**

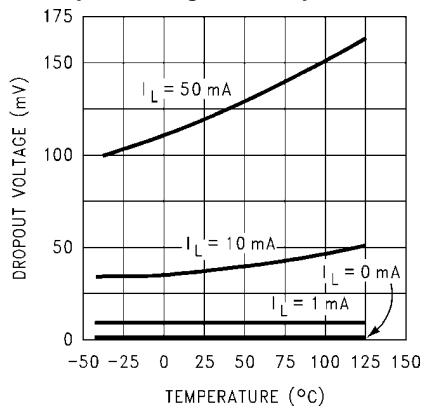

20207007

**Dropout Voltage vs. Load Current**

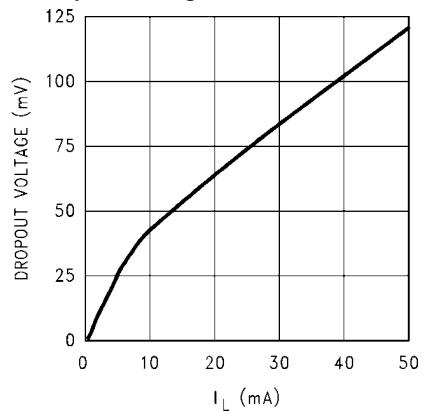

20207008

**Ground Pin Current vs. Temperature**

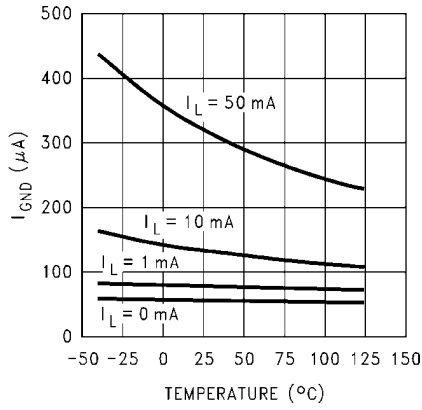

20207009

**Ground Pin Current vs. Load Current**

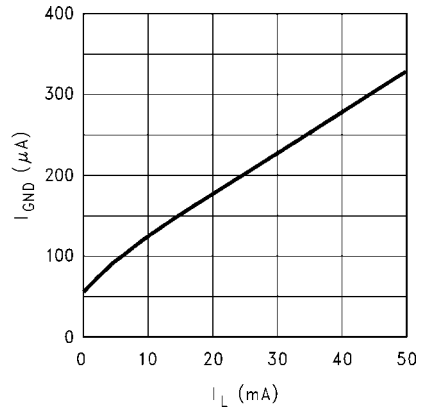

20207010

**Input Current vs.  $V_{IN}$**

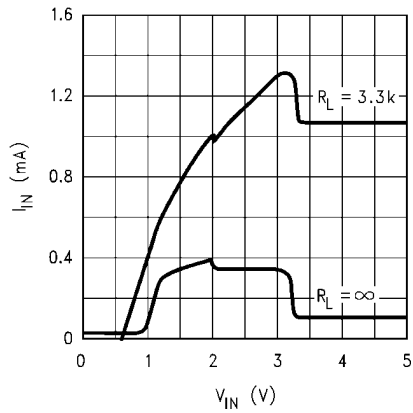

20207011

**Load Transient Response**

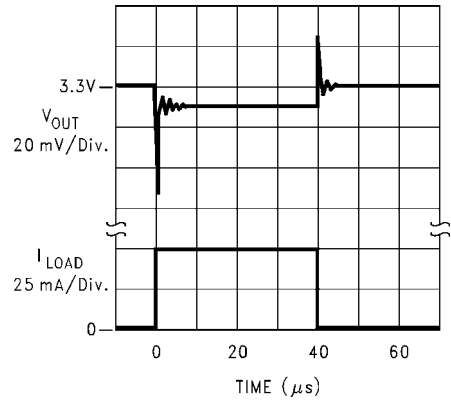

20207012

**Line Transient Response**

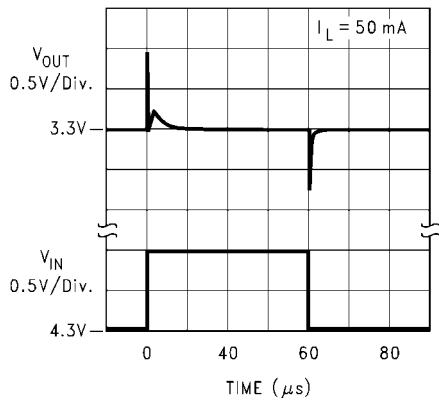

20207013

**Short Circuit Current**

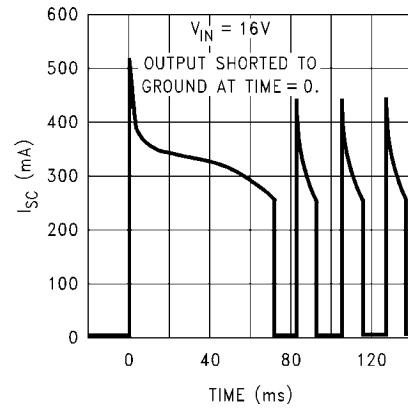

20207014

Short Circuit Current

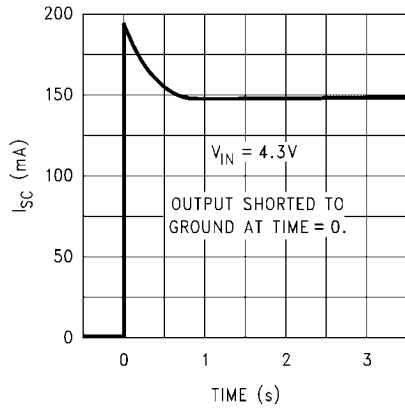

20207015

Load Regulation

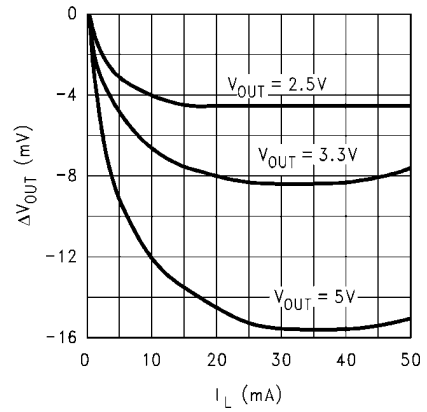

20207016

ADJ Pin Bias Current vs. Load Current

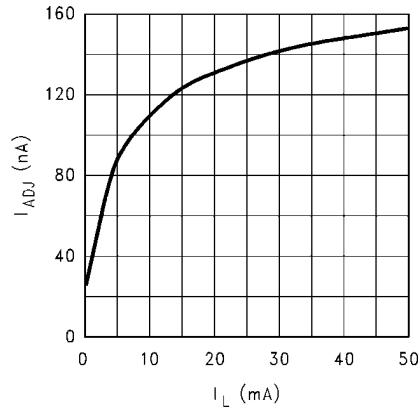

20207017

ADJ Pin Bias Current vs. Temperature

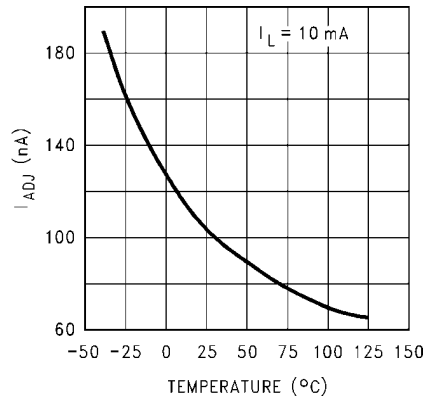

20207018

ON/OFF Threshold vs. Temperature

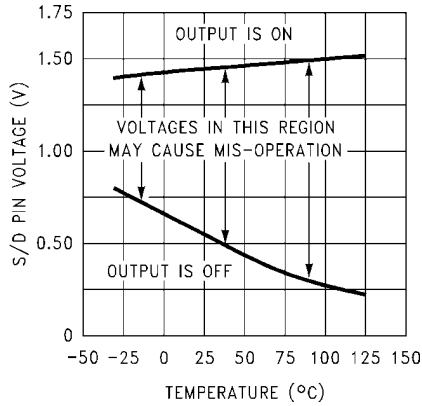

20207019

Output Noise Density

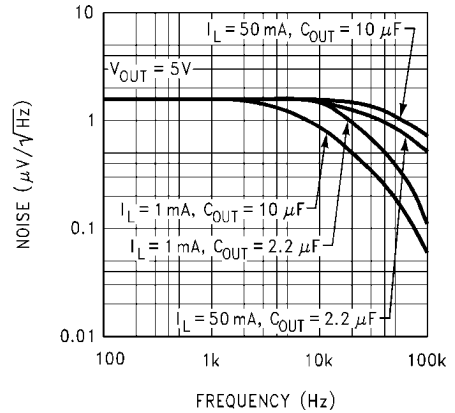

20207020

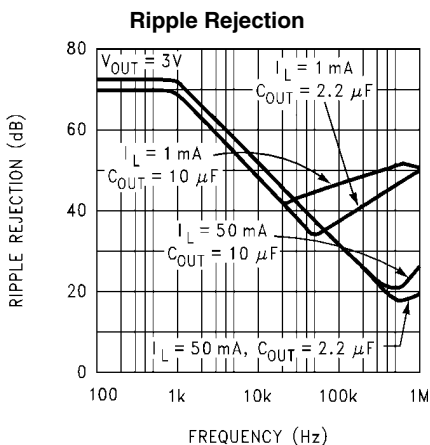

20207021

## Application Hints

### EXTERNAL CAPACITORS

Like any low-dropout regulator, the external capacitors must be selected carefully to assure regulator loop stability.

**INPUT CAPACITOR:** An input capacitor whose value is  $\geq 1\ \mu F$  is *required* (the amount of capacitance may be increased without limit).

Any good quality Tantalum or Ceramic capacitor may be used here. The capacitor must be located not more than 0.5 from the input pin and returned to a clean analog ground.

**OUTPUT CAPACITOR:** The output capacitor must meet both the requirement for minimum amount of capacitance and E.S.R. (Equivalent Series Resistance) for stable operation.

Curves are provided below which show the allowable ESR of the output capacitor as a function of load current for both 2.2  $\mu F$  and 4.7  $\mu F$ . A solid Tantalum capacitor is the best choice for the output.

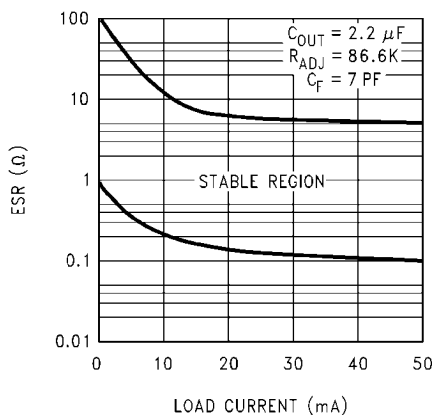

20207022

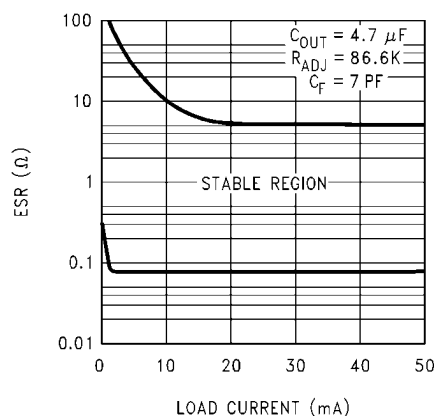

20207023

4.7  $\mu F$  ESR Curves

**IMPORTANT:** The output capacitor must maintain its ESR in the stable region *over the full operating temperature range* to assure stability. Also, capacitor tolerance and variation with temperature must be considered to assure the minimum amount of capacitance is provided at all times.

Note that this capacitor must be located not more than 0.5" from the output pin and returned to a clean analog ground.

**FEED-FORWARD CAPACITOR:** A 7 pF feed-forward capacitor is required (see Basic Application Circuit). The function of this capacitor is to provide the lead compensation necessary for loop stability.

A temperature-stable ceramic capacitor (type NPO or COG) should be used here.

### CAPACITOR CHARACTERISTICS

**TANTALUM:** The best capacitor choice for the LP2980-ADJEP output is solid Tantalum. The ESR of a good quality Tantalum is almost perfectly centered in the middle of the "stable" range of the ESR curve (about  $0.5\Omega$ – $1\Omega$ ).

The temperature stability of Tantalums is typically very good, with a total variation of only about 2:1 over the temperature range of  $-40^\circ C$  to  $+125^\circ C$  (ESR increases at colder temperatures).

Off-brand capacitors should be avoided, as some poor quality Tantalums are seen with ESR's  $> 10\Omega$ , and this usually causes oscillation problems.

One caution about Tantalums if they are used on the input: the ESR of a Tantalum is low enough that it can be destroyed by surge current if powered up from a low impedance source

(like a battery) that has no limit on inrush current. In these cases, use a ceramic input capacitor which does not have this problem.

**CERAMIC:** Ceramics are generally larger and more costly than Tantalums for a given amount of capacitance. Also, they have a very low ESR which is quite stable with temperature.

Be warned that the ESR of a ceramic capacitor is typically low enough to make an LDO oscillate: a 2.2  $\mu\text{F}$  ceramic demonstrated an ESR of about 15 m $\Omega$  when tested. If used as an output capacitor, this will cause instability (see ESR Curves).

If a ceramic is used on the output of an LDO, a small resistance (about 1 $\Omega$ ) should be placed in series with the capacitor. If it is used as an input capacitor, no resistor is needed as there is no requirement for ESR on capacitors used on the input.

**EXTERNAL RESISTORS**

The output voltage is set using two external resistors (see Basic Application Circuit). It is recommended that the resistor from the ADJ pin to ground be 51.1k.

The other resistor ( $R_{\text{ADJ}}$ ) which connects between  $V_{\text{OUT}}$  and the ADJ pin is selected to set  $V_{\text{OUT}}$  as given by the formula:

$$V_{\text{OUT}} = 1.23 + 1.23 (R_{\text{ADJ}}/51.1\text{k})$$

**REVERSE CURRENT PATH**

The power transistor used in the LP2980-ADJEP has an inherent diode connected between the input and output pin (see below).

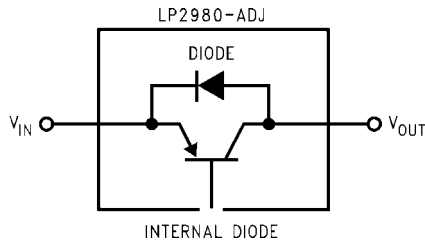

20207024

If the output is forced above the input by more than a  $V_{\text{BE}}$ , this diode will become forward biased and current will flow into the

output pin and out the input pin. This current must be limited to < 100 mA to prevent damage to the part.

The internal diode can also be turned on if the input voltage is abruptly stepped down to a voltage which is a  $V_{\text{BE}}$  below the output voltage. To prevent mis-operation, an external Schottky diode (see below) must be used in applications where the internal diode may be turned on.

Since the external Schottky diode turns on at a lower voltage than the internal diode, the Schottky conducts all of the current and prevents the internal diode from becoming forward biased.

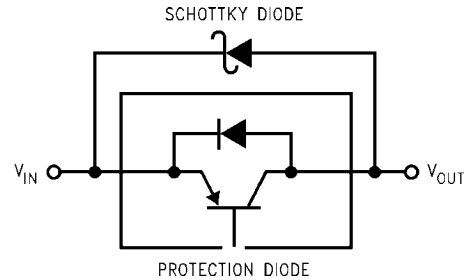

20207025

**ON/OFF INPUT OPERATION**

The LP2980-ADJEP is shut off by driving the ON/OFF input low, and turned on by pulling the ON/OFF input high. If this feature is not to be used, the ON/OFF input must be tied to  $V_{\text{IN}}$  to keep the regulator output on at all times (the ON/OFF input must not be left floating).

To ensure proper operation, the signal source used to drive the ON/OFF input must be able to swing above and below the specified turn-on/turn-off voltage thresholds which guarantee an ON or OFF state (see Electrical Characteristics).

It is also important that the turn-on (and turn-off) voltage signals applied to the ON/OFF input have a slew rate which is greater than 40 mV/ $\mu\text{s}$ .

**IMPORTANT:** The shutdown function will not operate correctly if a slow-moving signal is used to drive the S/D input.



**Physical Dimensions** inches (millimeters) unless otherwise noted

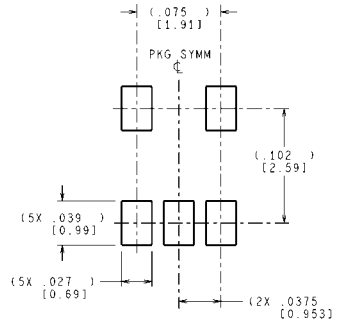
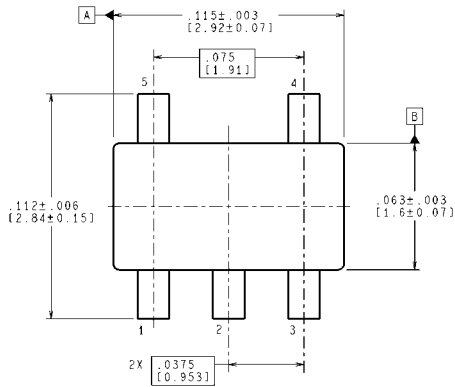

LAND PATTERN RECOMMENDATION

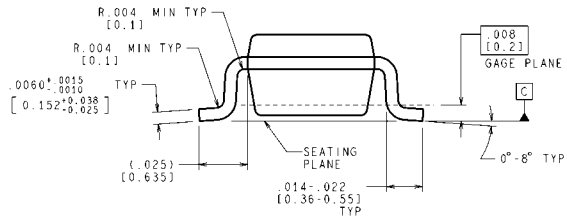
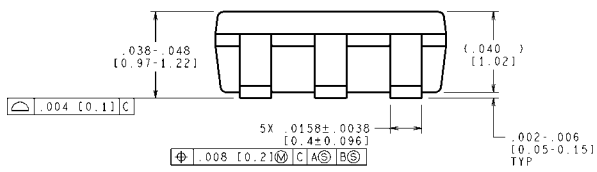

CONTROLLING DIMENSION IS INCH  
 VALUES IN [ ] ARE MILLIMETERS  
 DIMENSIONS IN ( ) FOR REFERENCE ONLY

**5-Lead Small Outline Package (M5)  
 NS Package Number MF05A**

MF05A (Rev C)

## Notes

THE CONTENTS OF THIS DOCUMENT ARE PROVIDED IN CONNECTION WITH NATIONAL SEMICONDUCTOR CORPORATION ("NATIONAL") PRODUCTS. NATIONAL MAKES NO REPRESENTATIONS OR WARRANTIES WITH RESPECT TO THE ACCURACY OR COMPLETENESS OF THE CONTENTS OF THIS PUBLICATION AND RESERVES THE RIGHT TO MAKE CHANGES TO SPECIFICATIONS AND PRODUCT DESCRIPTIONS AT ANY TIME WITHOUT NOTICE. NO LICENSE, WHETHER EXPRESS, IMPLIED, ARISING BY ESTOPPEL OR OTHERWISE, TO ANY INTELLECTUAL PROPERTY RIGHTS IS GRANTED BY THIS DOCUMENT.

TESTING AND OTHER QUALITY CONTROLS ARE USED TO THE EXTENT NATIONAL DEEMS NECESSARY TO SUPPORT NATIONAL'S PRODUCT WARRANTY. EXCEPT WHERE MANDATED BY GOVERNMENT REQUIREMENTS, TESTING OF ALL PARAMETERS OF EACH PRODUCT IS NOT NECESSARILY PERFORMED. NATIONAL ASSUMES NO LIABILITY FOR APPLICATIONS ASSISTANCE OR BUYER PRODUCT DESIGN. BUYERS ARE RESPONSIBLE FOR THEIR PRODUCTS AND APPLICATIONS USING NATIONAL COMPONENTS. PRIOR TO USING OR DISTRIBUTING ANY PRODUCTS THAT INCLUDE NATIONAL COMPONENTS, BUYERS SHOULD PROVIDE ADEQUATE DESIGN, TESTING AND OPERATING SAFEGUARDS.

EXCEPT AS PROVIDED IN NATIONAL'S TERMS AND CONDITIONS OF SALE FOR SUCH PRODUCTS, NATIONAL ASSUMES NO LIABILITY WHATSOEVER, AND NATIONAL DISCLAIMS ANY EXPRESS OR IMPLIED WARRANTY RELATING TO THE SALE AND/OR USE OF NATIONAL PRODUCTS INCLUDING LIABILITY OR WARRANTIES RELATING TO FITNESS FOR A PARTICULAR PURPOSE, MERCHANTABILITY, OR INFRINGEMENT OF ANY PATENT, COPYRIGHT OR OTHER INTELLECTUAL PROPERTY RIGHT.

### LIFE SUPPORT POLICY

**NATIONAL'S PRODUCTS ARE NOT AUTHORIZED FOR USE AS CRITICAL COMPONENTS IN LIFE SUPPORT DEVICES OR SYSTEMS WITHOUT THE EXPRESS PRIOR WRITTEN APPROVAL OF THE CHIEF EXECUTIVE OFFICER AND GENERAL COUNSEL OF NATIONAL SEMICONDUCTOR CORPORATION.** As used herein:

Life support devices or systems are devices which (a) are intended for surgical implant into the body, or (b) support or sustain life and whose failure to perform when properly used in accordance with instructions for use provided in the labeling can be reasonably expected to result in a significant injury to the user. A critical component is any component in a life support device or system whose failure to perform can be reasonably expected to cause the failure of the life support device or system or to affect its safety or effectiveness.

National Semiconductor and the National Semiconductor logo are registered trademarks of National Semiconductor Corporation. All other brand or product names may be trademarks or registered trademarks of their respective holders.

Copyright© 2007 National Semiconductor Corporation

For the most current product information visit us at [www.national.com](http://www.national.com)



**National Semiconductor Americas Customer Support Center**  
 Email: [new.feedback@nsc.com](mailto:new.feedback@nsc.com)  
 Tel: 1-800-272-9959

**National Semiconductor Europe Customer Support Center**  
 Fax: +49 (0) 180-530-85-86  
 Email: [europe.support@nsc.com](mailto:europe.support@nsc.com)  
 Deutsch Tel: +49 (0) 69 9508 6208  
 English Tel: +49 (0) 870 24 0 2171  
 Français Tel: +33 (0) 1 41 91 8790

**National Semiconductor Asia Pacific Customer Support Center**  
 Email: [ap.support@nsc.com](mailto:ap.support@nsc.com)

**National Semiconductor Japan Customer Support Center**  
 Fax: 81-3-5639-7507  
 Email: [jpn.feedback@nsc.com](mailto:jpn.feedback@nsc.com)  
 Tel: 81-3-5639-7560