

### Product Dimensions

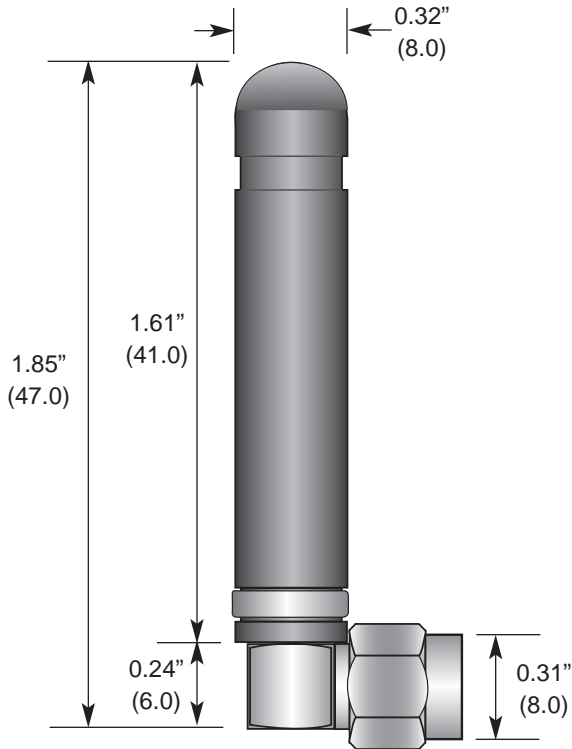

### Description



The RAH Series utilizes a helical element to greatly reduce the physical length of the antenna housing. They are ideal for products requiring an ultra-compact, aesthetically pleasing antenna in a right-angle form factor. Despite their tiny size, they are ruggedly constructed and able to withstand punishing environments just like our larger whips. The antennas attach via a Part 15 compliant RP-SMA connector.

### Features

- Low cost
- Ultra-compact
- Right-angle mount
- Excellent performance
- Omni-directional pattern
- Fully weatherized
- Flexible main shaft
- Rugged & damage-resistant
- Part 15 compliant RP-SMA connector
- Use with plastic\* or metal enclosures

\* Requires proximity ground plane

### Electrical Specifications

- Center Freq. 418MHz
- Bandwidth 15MHz
- Wavelength 1/4-wave
- VSWR <1.9 typ. at center
- Impedance 50 ohms
- Connector RP-SMA

Electrical specifications and plots measured on 4.00" x 4.00" reference ground plane

### Ordering Information

- ANT-418-CW-RAH

### VSWR Graph

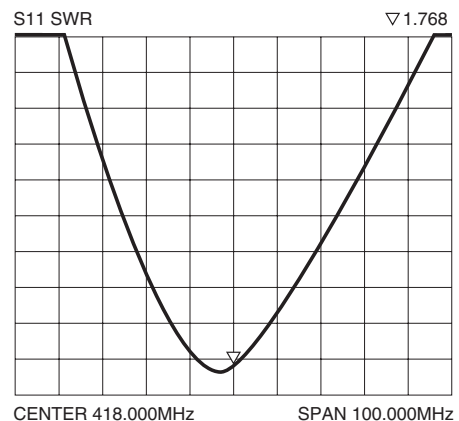

Typical VSWR