



FEATURES

- RoHS compliant
- 0.28μH to 1.0mH
- Up to 8A I_{DC}
- Bobbin format
- Surface mount
- Integral EMI shield
- Compact size
- Tape and reel packaging
- UL 94V-0 materials
- J-STD-020-C reflow

DESCRIPTION

The 4500 series is a lower profile version of our 4600 series range of bobbin-wound, shielded inductors. They are suitable for power-line filtering found in consumer electronics such as desktop computers, LED applications and GPS systems, as well as in a vast range of industrial and telecom applications including network hubs, bridges & routers, and high frequency wireless communication devices.

These surface mount inductors are extremely compact and have an integral shield, making them useful in EMI sensitive applications.

PIN CONNECTIONS (TOP VIEW)

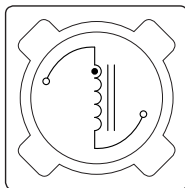

SELECTION GUIDE

Order Code	Inductance (10kHz, 0.1V _{AC}) ±20%	DC Current ¹	DC Resistance
	Nom.	Max.	Max.
	μH	A	mΩ
45281C	0.28 (±30%)	8.0	9
45541C	0.54 (±30%)	7.0	11
45102C	1.0 (±30%)	6.0	14
45152C	1.5 (±30%)	5.5	17
45222C	2.2 (±30%)	4.5	26
45332C	3.3 (±30%)	3.7	34
45472C	4.7 (±30%)	3.2	47
45682C	6.8 (±30%)	2.6	66
45103C	10	2.2	82
45153C	15	1.8	120
45223C	22	1.35	180
45333C	33	1.25	250
45473C	47	1.05	360
45683C	68	0.82	510
45104C	100	0.70	710
45154C	150	0.58	1000
45224C	220	0.50	1550
45334C	330	0.35	2540
45474C	470	0.32	3250
45684C	680	0.26	5000
45105C	1000	0.23	6500

MECHANICAL DIMENSIONS

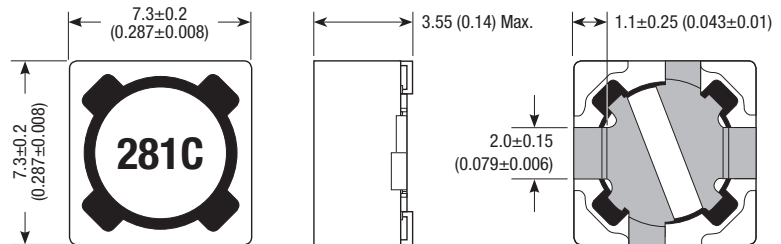

Recommended Footprint Details*

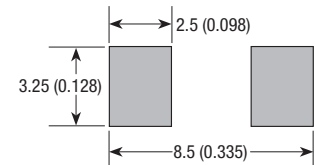

*Distance between the outside ends of the terminations is 7.1±0.1 (0.28±0.004)
 Unless otherwise stated, all dimensions in mm (inches) ± 0.25 (0.010).
 Package weight: 0.64g Typ.

ABSOLUTE MAXIMUM RATINGS

Operating temperature range	-40°C to 125°C
Storage temperature range	-40°C to 150°C

SOLDERING INFORMATION²

Peak reflow solder temperature	250°C
Pin finish	Tin

Specifications typical at T_A = 25°C

1 Maximum DC current occurs when either the inductance falls to 75% of its nominal value or when its temperature rise reaches 40°C, whichever is sooner.

2 For further information, please visit www.murata-ps.com/rohs



INDUCTANCE Vs CURRENT

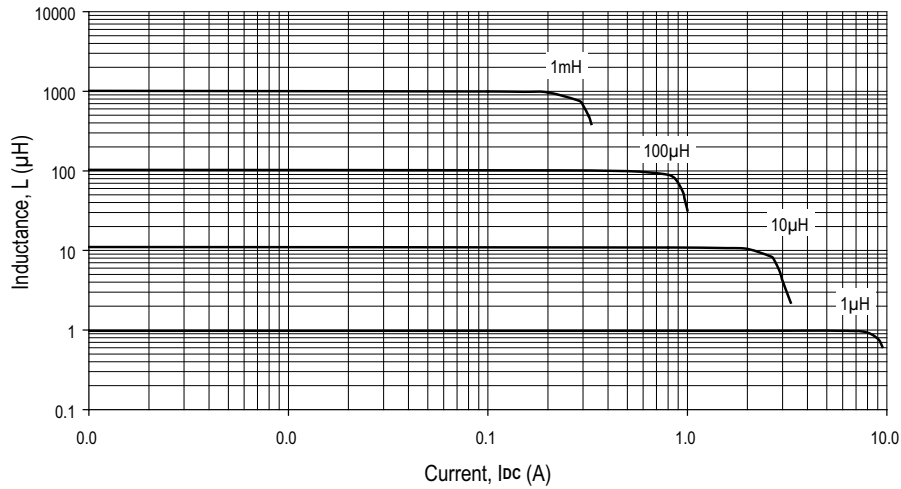

TEMPERATURE Vs CURRENT

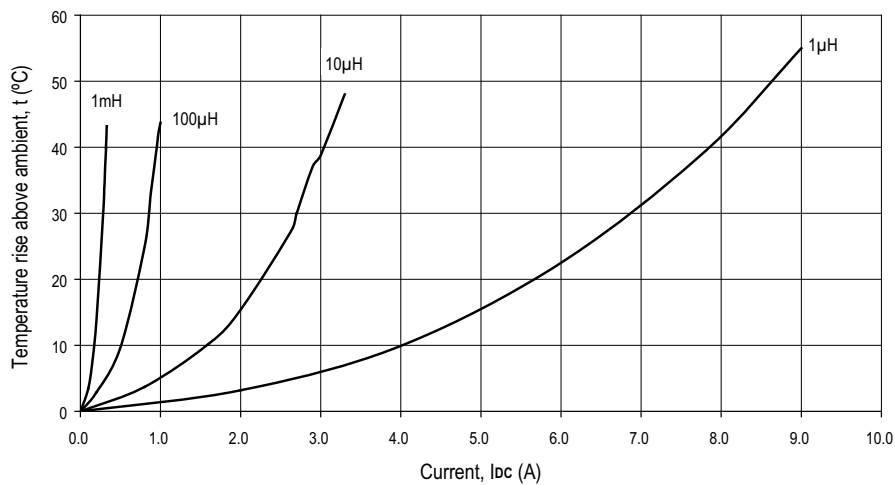

INDUCTANCE Vs FREQUENCY

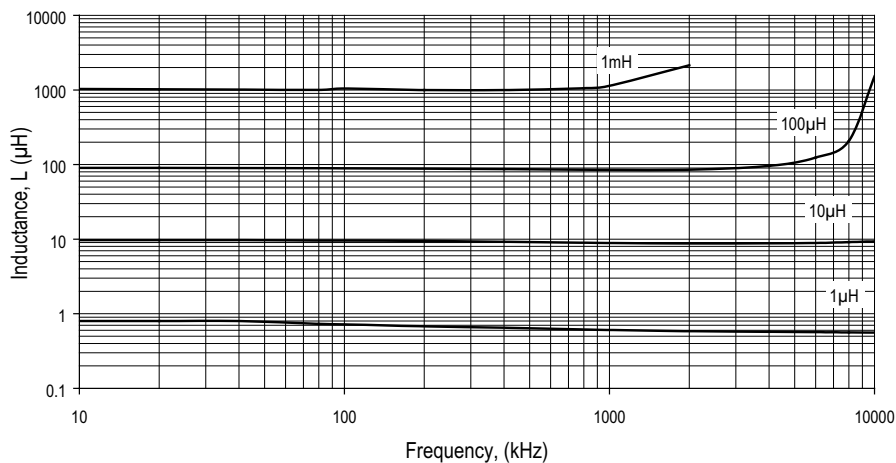

TAPE & REEL SPECIFICATIONS

REEL OUTLINE DIMENSIONS

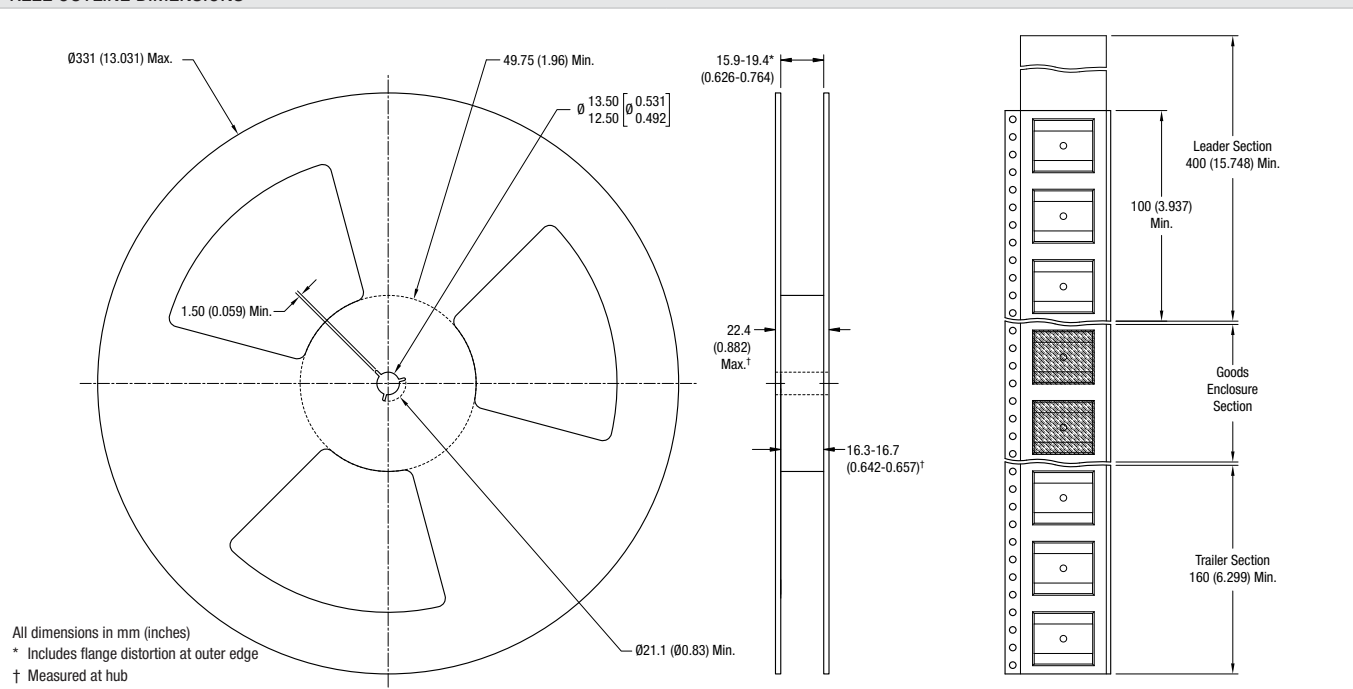

TAPE OUTLINE DIMENSIONS

