

## TO-126 Plastic-Encapsulate Transistors

**TIP122** Darlington Transistor (NPN)

**TIP127** Darlington Transistor (PNP)

### FEATURES

- Medium Power Complementary Silicon Transistors

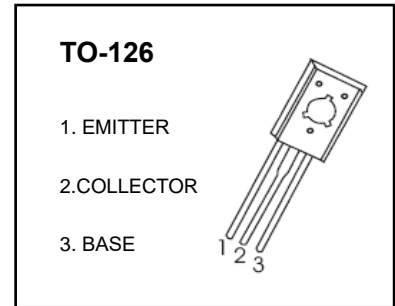

### MARKING

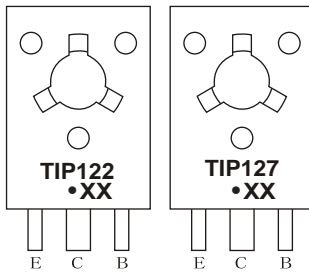

TIP122 , TIP127=Device code  
 Solid dot = Green molding compound device, if none, the normal device  
 XX=Code

### Equivalent Circuit

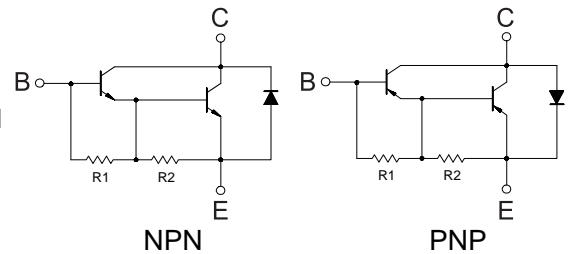

R1 typ. =5 K R2 typ. =210

R1 typ. =5 K R2 typ. =210

### ORDERING INFORMATION

Part Number	Package	Packing Method	Pack Quantity
TIP122	TO-126	Bulk	200pcs/Bag
TIP127	TO-126	Bulk	200pcs/Bag
TIP122-TU	TO-126	Tube	60pcs/Tube
TIP127-TU	TO-126	Tube	60pcs/Tube

### MAXIMUM RATINGS (T<sub>a</sub>=25°C unless otherwise noted)

Symbol	Parameter	TIP122	TIP127	Unit
V <sub>CBO</sub>	Collector-Base Voltage	100	-100	V
V <sub>CEO</sub>	Collector-Emitter Voltage	100	-100	V
V <sub>EBO</sub>	Emitter-Base Voltage	5	-5	V
I <sub>C</sub>	Collector Current -Continuous	5	-5	A
P <sub>C</sub> *	Collector Power Dissipation	1.25		W
R <sub>θJA</sub>	Thermal Resistance Junction to Ambient	100		°C/W
R <sub>θJC</sub>	Thermal Resistance Junction to Case	8.33		°C/W
T <sub>J</sub> , T <sub>stg</sub>	Operation Junction and Storage Temperature Range	-55~+150		°C

## ELECTRICAL CHARACTERISTICS

$T_a=25^\circ\text{C}$  unless otherwise specified

<b>TIP122</b>					NPN
Parameter	Symbol	Test conditions	Min	Max	Unit
<b>Collector-base breakdown voltage</b>	$V_{(BR)CBO}$	$I_C=1\text{mA}, I_E=0$	100		V
<b>Collector-emitter breakdown voltage</b>	$V_{CEO(SUS)}$	$I_C=30\text{mA}, I_B=0$	100		V
<b>Collector cut-off current</b>	$I_{CBO}$	$V_{CB}=100\text{V}, I_E=0$		0.2	mA
<b>Collector cut-off current</b>	$I_{CEO}$	$V_{CE}=50\text{V}, I_B=0$		0.5	mA
<b>Emitter cut-off current</b>	$I_{EBO}$	$V_{EB}=5\text{V}, I_C=0$		2	mA
<b>DC current gain</b>	$h_{FE(1)}$	$V_{CE}=3\text{V}, I_C=0.5\text{A}$	1000		
	$h_{FE(2)}$	$V_{CE}=3\text{V}, I_C=3\text{A}$	1000	12000	
<b>Collector-emitter saturation voltage</b>	$V_{CE(sat)}$	$I_C=3\text{A}, I_B=12\text{mA}$		2	V
		$I_C=5\text{A}, I_B=20\text{mA}$		4	
<b>Base-emitter voltage</b>	$V_{BE}$	$V_{CE}=3\text{V}, I_C=3\text{A}$		2.5	V
<b>Output Capacitance</b>	$C_{ob}$	$V_{CB}=10\text{V}, I_E=0, f=0.1\text{MHz}$		200	pF

<b>TIP127</b>					PNP
Parameter	Symbol	Test conditions	Min	Max	Unit
<b>Collector-base breakdown voltage</b>	$V_{(BR)CBO}$	$I_C=-1\text{mA}, I_E=0$	-100		V
<b>Collector-emitter breakdown voltage</b>	$V_{CEO(SUS)}$	$I_C=-30\text{mA}, I_B=0$	-100		V
<b>Collector cut-off current</b>	$I_{CBO}$	$V_{CB}=-100\text{V}, I_E=0$		-0.2	mA
<b>Collector cut-off current</b>	$I_{CEO}$	$V_{CE}=-50\text{V}, I_B=0$		-0.5	mA
<b>Emitter cut-off current</b>	$I_{EBO}$	$V_{EB}=-5\text{V}, I_C=0$		-2	mA
<b>DC current gain</b>	$h_{FE(1)}$	$V_{CE}=-3\text{V}, I_C=-0.5\text{A}$	1000		
	$h_{FE(2)}$	$V_{CE}=-3\text{V}, I_C=-3\text{A}$	1000	12000	
<b>Collector-emitter saturation voltage</b>	$V_{CE(sat)}$	$I_C=-3\text{A}, I_B=-12\text{mA}$		-2	V
		$I_C=-5\text{A}, I_B=-20\text{mA}$		-4	
<b>Base-emitter voltage</b>	$V_{BE}$	$V_{CE}=-3\text{V}, I_C=-3\text{A}$		-2.5	V
<b>Output Capacitance</b>	$C_{ob}$	$V_{CB}=-10\text{V}, I_E=0, f=0.1\text{MHz}$		300	pF

\* This test is performed with no heat sink at  $T_a=25^\circ\text{C}$ .

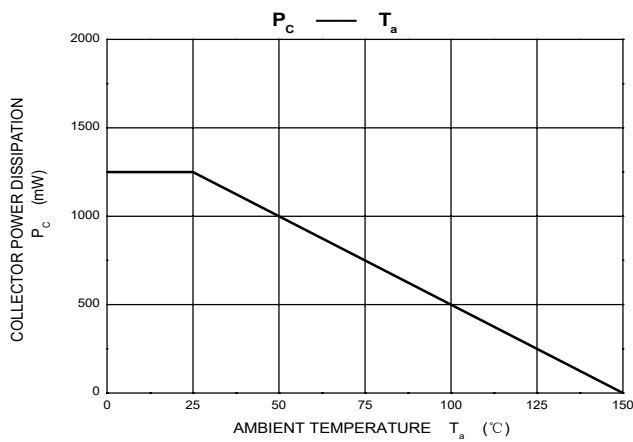
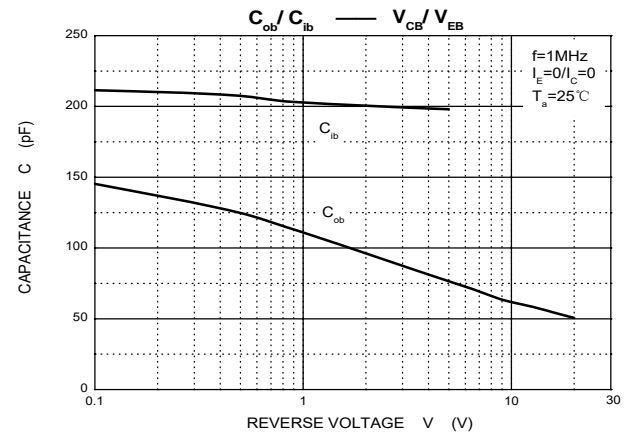
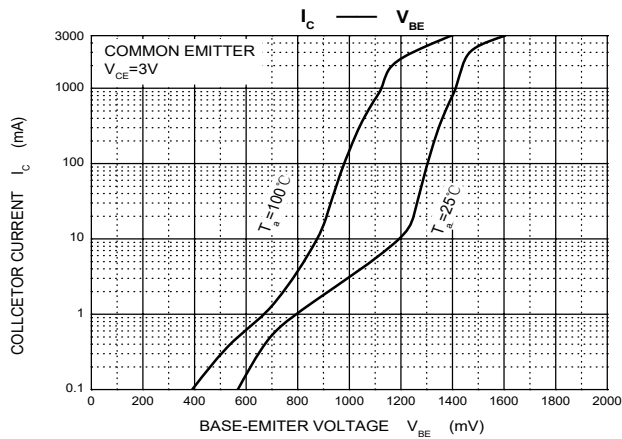
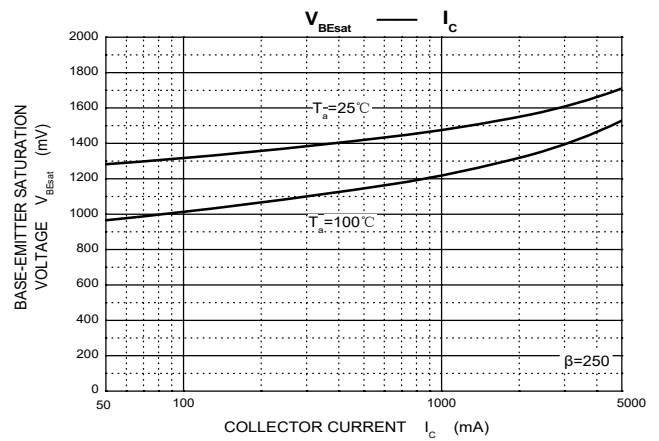
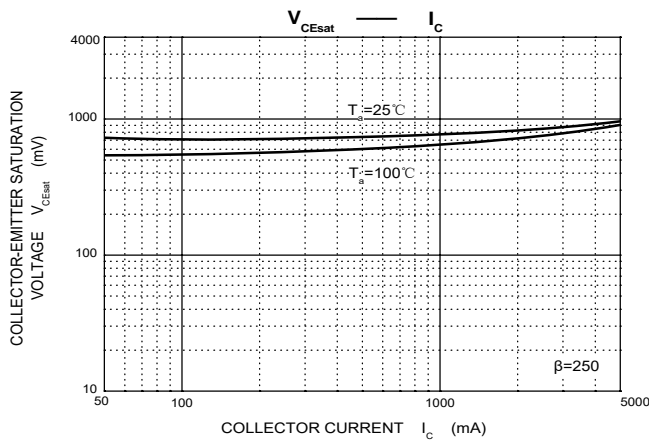
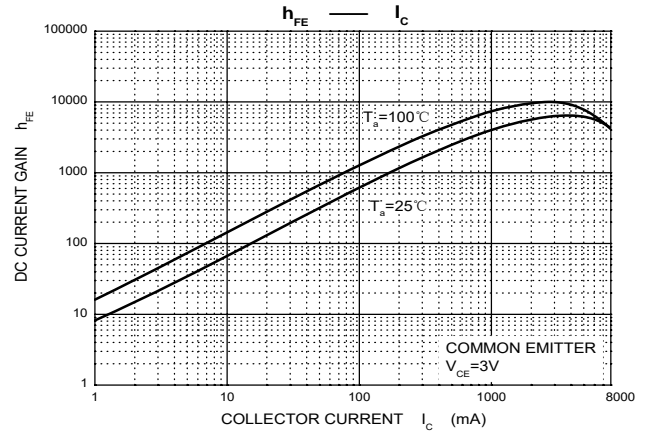
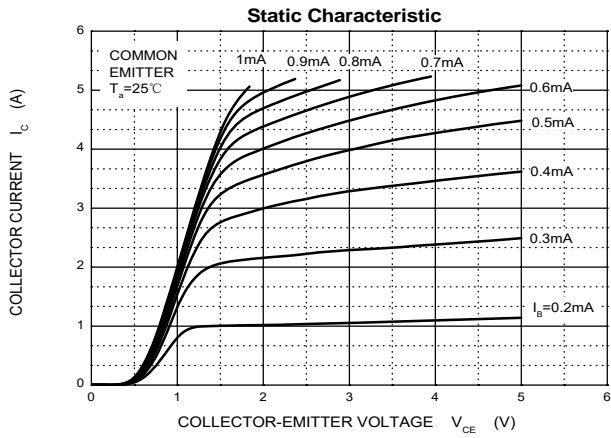

# TO-126 Package Outline Dimensions



Symbol	Dimensions In Millimeters		Dimensions In Inches	
	Min	Max	Min	Max
A	2.500	2.900	0.098	0.114
A1	1.100	1.500	0.043	0.059
b	0.660	0.860	0.026	0.034
b1	1.170	1.370	0.046	0.054
c	0.450	0.600	0.018	0.024
D	7.400	7.800	0.291	0.307
E	10.600	11.000	0.417	0.433
e	2.290 TYP		0.090 TYP	
e1	4.480	4.680	0.176	0.184
h	0.000	0.300	0.000	0.012
L	15.300	15.700	0.602	0.618
L1	2.100	2.300	0.083	0.091
P	3.900	4.100	0.154	0.161
Φ	3.000	3.200	0.118	0.126