

Resettable Fuse PTC SMD2920 Series

Features

RoHS Compliant & Halogen Free

faster tripping, 2920 Dimension, Surface mountable, Solid state

Operation Current: 0.30A~3.0A

Maximum Voltage: 6V~60Vdc

Operating Temperature: -40°C to +85°C

Agency recognition:



Dimensions(7555mm/ 2920 mils) Unit: mm

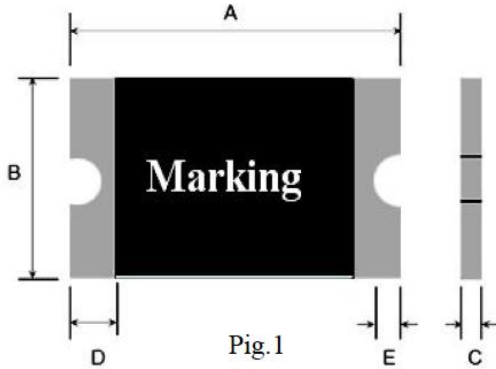

Terminal pad materials :Tin-Plated Nickle-copper
Terminal pad solderability : Meets EIA specification
RS 186-9E and ANSI/J-STD-002 Category 3.

Part number	Marking	A		B		C		D	E	Certification		Delivery Time	
		Min	max	Min	Max	Min	Max	Min	Min	UL	TUV	in stock	Produce
SMD030L	JK030L	6.73	7.98	4.8	5.44	0.6	1.15	0.30	0.15	√	-	3days	18days
SMD050L	JK050L	6.73	7.98	4.8	5.44	0.6	1.15	0.30	0.15	√	-	3days	18days
SMD075L	JK075L	6.73	7.98	4.8	5.44	0.6	1.15	0.30	0.15	√	-	3days	18days
SMD100L	JK100L	6.73	7.98	4.8	5.44	0.6	1.00	0.30	0.15	√	-	3days	18days
SMD125L	JK125L	6.73	7.98	4.8	5.44	0.6	1.00	0.30	0.15	√	-	3days	18days
SMD150L	JK150L	6.73	7.98	4.8	5.44	0.6	1.20	0.30	0.15	√	-	3days	18days
SMD185L	JK185L	6.73	7.98	4.8	5.44	0.6	1.20	0.30	0.15	√	-	3days	18days
SMD200L	JK200L	6.73	7.98	4.8	5.44	0.4	0.80	0.30	0.15	√	-	3days	18days
SMD200L-24	JK200L	6.73	7.98	4.8	5.44	0.6	1.00	0.30	0.15	√	-	3days	18days
SMD250L	JK250L	6.73	7.98	4.8	5.44	0.4	0.80	0.30	0.15	√	-	3days	18days
SMD260L	JK260L	6.73	7.98	4.8	5.44	0.4	0.80	0.30	0.15	√	-	3days	18days
SMD300L-6	JK300L	6.73	7.98	4.8	5.44	0.4	0.80	0.30	0.15	√	-	3days	18days
SMD300L-16	JK300L	6.73	7.98	4.8	5.44	0.6	1.20	0.30	0.15	√	-	3days	18days

Specifications are subject to change without notice

1

Tel: +86-755-27465585

HUAAN LIMITED

www.huaandz.com

Email: sales@huaandz.com

Thermal Derating Chart-IH(A)



Maximum ambient operating temperatures °C									
Part Number	-40°C	-20°C	0°C	25°C	40°C	50°C	60°C	70°C	85°C
SMD030L	0.44	0.37	0.35	0.30A	0.28	0.23	0.20	0.18	0.14
SMD050L	0.73	0.62	0.59	0.50A	0.47	0.38	0.34	0.30	0.24
SMD075L	1.09	0.92	0.88	0.75A	0.70	0.56	0.50	0.45	0.36
SMD100L	1.45	1.23	1.17	1.00A	0.93	0.75	0.67	0.60	0.48
SMD125L	1.81	1.54	1.46	1.25A	1.16	0.94	0.84	0.75	0.60
SMD150L	2.18	1.85	1.76	1.50A	1.40	1.13	1.01	0.90	0.72
SMD185L	2.68	2.28	2.16	1.85A	1.72	1.39	1.24	1.11	0.89
SMD200L	2.90	2.46	2.34	2.00A	1.86	1.50	1.34	1.20	0.96
SMD200L-24	2.90	2.46	2.34	2.00A	1.86	1.50	1.34	1.20	0.96
SMD250L	3.63	3.08	2.93	2.50A	2.33	1.88	1.68	1.50	1.20
SMD260L	3.77	3.20	3.04	2.60A	2.42	1.95	1.74	1.56	1.25
SMD300L-6	4.35	3.69	3.51	3.00A	2.79	2.25	2.01	1.80	1.44
SMD300L-16	4.35	3.69	3.51	3.00A	2.79	2.25	2.01	1.80	1.44

Electrical characteristics(25°C)

Part Number	I _{Hold}	I _{Trip}	V _{max}	I _{max}	P _d Max	Maximum Time to Trip		Resistance (Ω)		Certification		Delivery Time	
	A	A	DC	A	W	Current (A)	Time (S)	R _{imin}	R _{1max}	UL	TUV	in stock	Produce
SMD030L	0.30	0.60	60V	100	1.5	1.5	3.0	0.60	4.80	√	-	3days	18days
SMD050L	0.50	1.00	60V	100	1.5	2.5	4.0	0.18	1.40	√	-	3days	18days
SMD075L	0.75	1.50	33V	100	1.5	8.0	0.3	0.10	1.00	√	-	3days	18days
SMD100L	1.00	2.20	33V	100	1.5	8.0	0.5	0.065	0.41	√	-	3days	18days
SMD125L	1.25	2.50	33V	100	1.5	8.0	2.0	0.05	0.25	√	-	3days	18days
SMD150L	1.50	3.00	33V	100	1.5	8.0	2.0	0.035	0.23	√	-	3days	18days
SMD185L	1.85	3.70	33V	100	1.5	8.0	2.5	0.03	0.15	√	-	3days	18days
SMD200L	2.00	4.00	16V	100	1.5	8.0	4.5	0.02	0.12	√	-	3days	18days
SMD200L-24	2.00	4.00	24V	100	1.5	8.0	4.5	0.02	0.12	√	-	3days	18days
SMD250L	2.50	5.00	16V	100	1.5	8.0	16.0	0.02	0.085	√	-	3days	18days
SMD260L	2.60	5.20	16V	100	1.5	8.0	10.0	0.014	0.075	√	-	3days	18days
SMD300L-6	3.00	6.00	6V	100	1.5	8.0	20.0	0.012	0.048	√	-	3days	18days
SMD300L-16	3.00	6.00	16V	100	1.5	8.0	20.0	0.012	0.05	√	-	3days	18days

Electrical characteristics(25°C)

I_{hold} = Hold Current. Maximum current device will not trip in 25°C still air.

I_{trip} = Trip Current. Minimum current at which the device will always trip in 25°C still air.

V_{max} = Maximum operating voltage device can withstand without damage at rated current (I_{max}).

I_{max} = Maximum fault current device can withstand without damage at rated voltage (V_{max}).

P_d = Maximum power dissipation when device is in the tripped state in 25°C still air environment at rated voltage.

$R_{i_{min/max}}$ = Minimum/Maximum device resistance prior to tripping at 25°C.

$R_{1_{max}}$ = Maximum device resistance is measured one hour post reflow.

Part number System

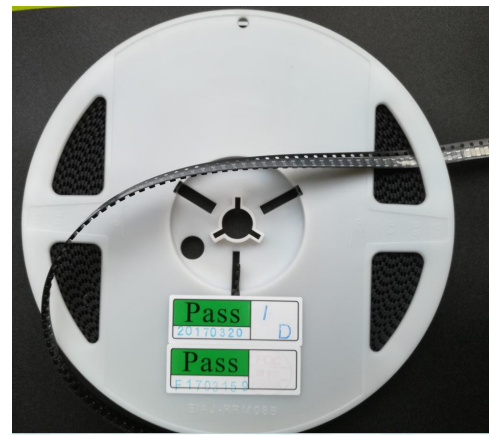
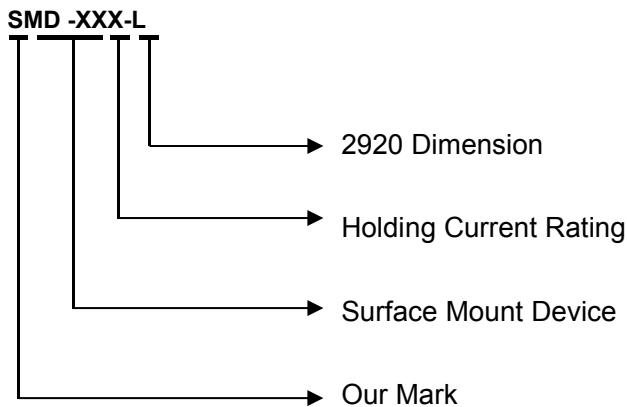

Test Procedures and Requirements

Test	Test Conditions	Accept/Reject Criteria
Resistance	In still air @ 25°C	$R_{min} \leq R \leq R_{max}$
Time to Trip	Specified current, V_{max} , 25°C	Tmaximum Time to Trip
Hold Current	30min ,at I_H	No trip
Trip Cycle Life	V_{max} , I_{max} , 100cycles	No arcing or burning
Trip Endurance	V_{max} , 1hours	No arcing or burning

Physical Characteristics and Environmental Specifications

Physical Characteristics

Terminal materials :	Tin-Plated Nickle-copper
Soldering zone	Meets EIA specification RS 186-9E and ANSI/J-STD-002 Category 3.

Environmental Specifications

Test	Conditions	Resistance change
Passive aging	+85°C, 1000hours	±10%
Humidity aging	+85°C/85%R.H.1000hours	±5%
Thermal shock	MIL-STD-202,Method 107G ,+85°C/-40°C,20times	-30% typical resistance change
Solvent Resistance	MIL-STD-202,Method 215	No change
Vibration	ML-STD-883C,Test Condition A	No change

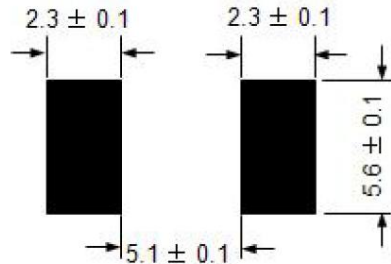

Solder reflow conditions

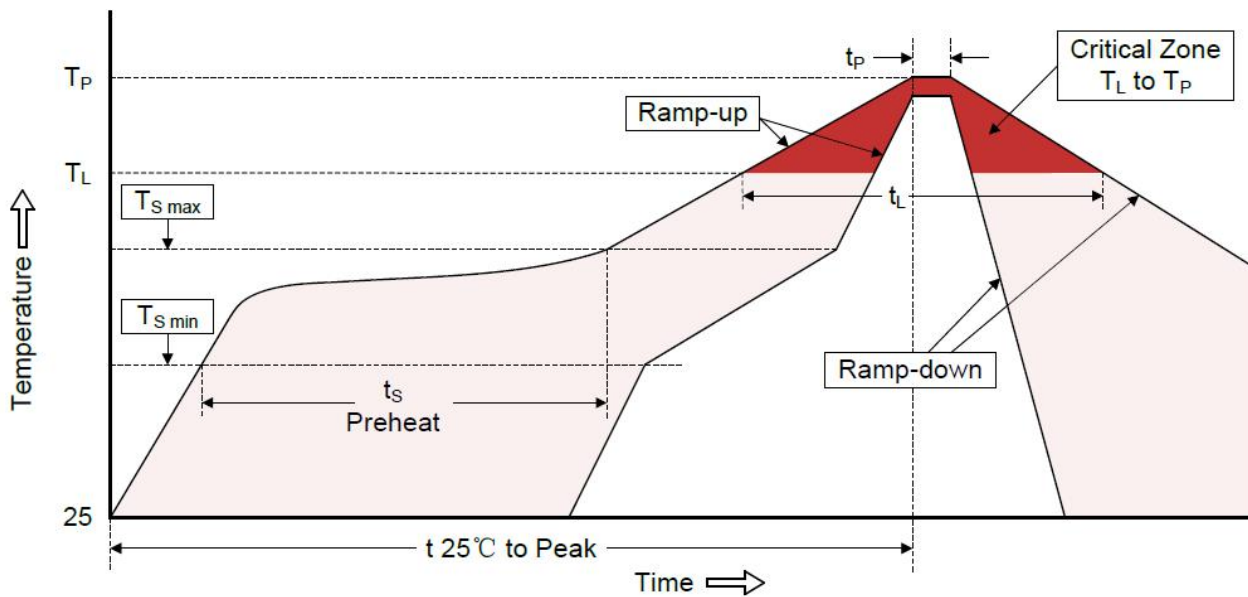

Profile Feature	Pb-Free Assembly
Average ramp-up rate (TS max to TP)	3°C/second max.
Preheat	
-Temperature Min (TS min)	150°C
-Temperature Max (TS max)	200°C
-Time (min to max) (TS min to TS max)	60-180 seconds
Time maintained above:	
-Temperature (TL)	217°C
-Time (tL)	60-150 seconds
Peak Temperature (TP)	260°C
Time within 5°C of actual Peak Temperature (tP)	20-40 seconds
Ramp-down Rate	3°C/second max.
Time 25°C to Peak Temperature	8 minutes max.
Storage Condition	0°C~35°C, ≤70%RH

• Recommended reflow methods: IR, vapor phase oven, hot air oven, N2 environment for lead-free

Specifications are subject to change without notice

Tel: +86-755-27465585

Solder reflow conditions

- Devices are not designed to be wave soldered to the bottom side of the board.
- Recommended maximum paste thickness is 0.25mm (0.010 inch)
- Device can be cleaned using standard industry methods and solvents.
- Soldering temperature profile meets RoHs leadfree process.

Note : If reflow temperatures exceed the recommended profile, devices may not meet the performance Requirements

Tape Specification and Reel Dimensions

Tape

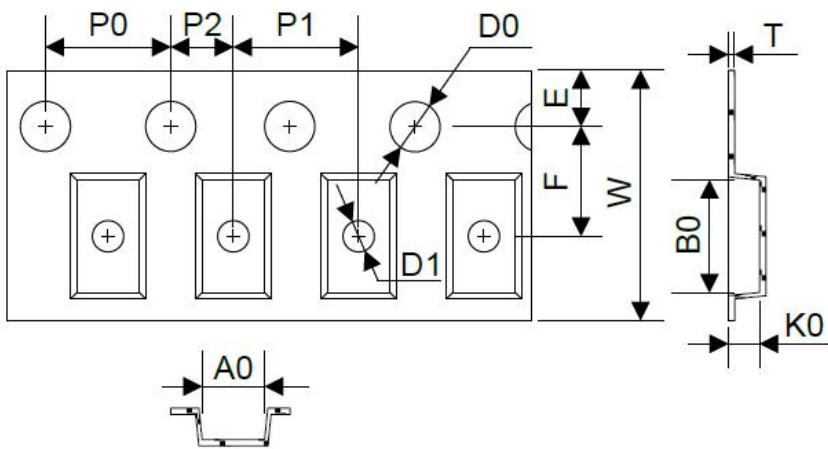

Symbol	Dimensions(mm)
--------	----------------

W	16.00±0.30
F	7.50±0.1
E	1.75±0.10
D0	1.55±0.05
D1	1.50(MIN)
P0	4.00±0.10
P1	8.00±0.10
P2	2.00±0.10
A0	5.74±0.10
B0	8.02±0.10
T	0.30±0.10
K0	1.3/0.91/2.0±0.10

Leader min 390

Trailer min 160

Reel

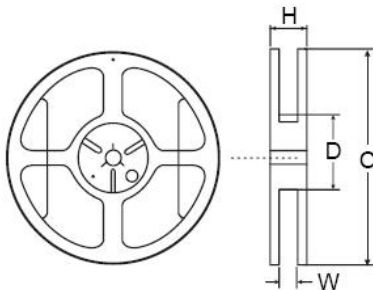

C $\Phi 180 \pm 3.0$

D $\Phi 60.0 \pm 0.5$

H 19.5±1.0

W 17.0±0.2

Packaging Quantity

Part Number	Quantity	Part Number	Quantity	Part Number	Quantity
SMD030L	2000PCS	SMD150L	2000PCS	SMD260L	2000PCS
SMD050L	2000PCS	SMD185L	1500PCS	SMD300L-6	2000PCS
SMD075L	2000PCS	SMD200L	2000PCS	SMD300L-16	1500PCS
SMD100L	2000PCS	SMD200L-24	1500PCS	--	--
SMD125L	2000PCS	SMD250L	2000PCS	--	--

Resettable Fuse PTC SMD2920 Series**Storage**

The maximum ambient temperature shall not exceed 38°C. Storage temperatures higher than 38°C could result in the deformation of packaging materials. The maximum relative humidity recommended for storage is 60%. High humidity with high temperature can accelerate the oxidation of the solder plating on the termination and reduce the solderability of the components. Sealed plastic bags with desiccant shall be used to reduce the oxidation of the termination and shall only be opened prior to use. The products shall not be stored in areas where harmful gases containing sulfur or chlorine are present.

Warning

- Use PPTC beyond the maximum ratings or improper use may result in device damage and possible electrical arcing and flame.
- PPTC are intended for protection against occasional over current or over temperature fault conditions and should not be used when repeated fault conditions or prolonged trip events are anticipated.
- Device performance can be impacted negatively if devices are handled in a manner inconsistent with recommended electronic, thermal, and mechanical procedures for electronic components.
- Use PPTC with a large inductance in circuit will generate a circuit voltage ($L di/dt$) above the rated voltage of the PPTC.
- Avoid impact PPTC device its thermal expansion like placed under pressure or installed in limited space.
- Contamination of the PPTC material with certain silicon based oils or some aggressive solvents can adversely impact the performance of the devices. PPTC SMD can be cleaned by standard methods.
- Requests that customers comply with our recommended solder pad layouts and recommended reflow profile. Improper board layouts or reflow profile could negatively impact solderability performance of our devices.

Notes

The specification is intended to present application, product and technical data to assist the user in selecting PPTC circuit production devices. However, users should independently evaluate and test the suitability of each product. HUAAN makes no warranties as to the accuracy or completeness of the information and disclaims any liability resulting from its use, HUAAN's only obligations are those in the HUAAN Standard Terms and Conditions of Sale and in no case will HUAAN be liable for any incidental, indirect, or consequential damages arising from the sale, resale, or misuse of its products. HUAAN reserves the right to change or update, without notice, any information contained in this specification.