



SANYO Semiconductors

DATA SHEET

An ON Semiconductor Company

2SC5536A — NPN Epitaxial Planar Silicon Transistor VHF Low-Noise Amplifier, OSC Applications

Features

- Low-noise : NF=1.8dB typ (f=150MHz)
- High gain : $|S_{21e}|^2=16\text{dB}$ typ (f=150MHz)
- Ultrasmall, slim flat-lead package (1.4mm×0.8mm×0.6mm)
- Halogen free compliance

Specifications

Absolute Maximum Ratings at Ta=25°C

Parameter	Symbol	Conditions	Ratings	Unit
Collector-to-Base Voltage	VCBO		20	V
Collector-to-Emitter Voltage	VCEO		12	V
Emitter-to-Base Voltage	VEBO		2	V
Collector Current	IC		50	mA
Collector Dissipation	PC		100	mW
Junction Temperature	Tj		150	°C
Storage Temperature	Tstg		-55 to +150	°C

Package Dimensions

unit : mm (typ)
7029A-002

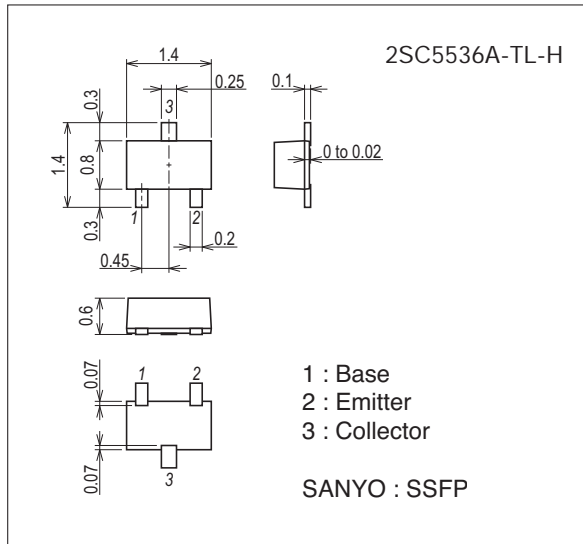

Product & Package Information

- Package : SSFP
- JEITA, JEDEC : SC-81
- Minimum Packing Quantity : 8,000 pcs./reel

Packing Type: TL

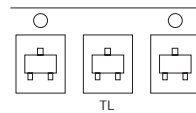

Marking

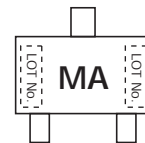

Electrical Connection

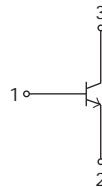

2SC5536A

Electrical Characteristics at Ta=25°C

Parameter	Symbol	Conditions	Ratings			Unit
			min	typ	max	
Collector Cutoff Current	I_{CBO}	$V_{CB}=10V, I_E=0A$			1.0	μA
Emitter Cutoff Current	I_{EBO}	$V_{EB}=1V, I_C=0A$			10	μA
DC Current Gain	h_{FE1}	$V_{CE}=2V, I_C=3mA$	80		200	
	h_{FE2}	$V_{CE}=2V, I_C=50mA$	70			
Gain-Bandwidth Product	f_T	$V_{CE}=2V, I_C=3mA$	1.0	1.7		GHz
Output Capacitance	C_{ob}	$V_{CB}=10V, f=1MHz$		1.1	1.8	pF
Reverse Transfer Capacitance	C_{re}			0.8		pF
Forward Transfer Gain	$ S_{21e} ^2$	$V_{CE}=2V, I_C=3mA, f=150MHz$	13	16		dB
Noise Figure	NF			1.8	3.0	dB

Ordering Information

Device	Package	Shipping	memo
2SC5536A-TL-H	SSFP	8,000pcs./reel	Pb Free and Halogen Free

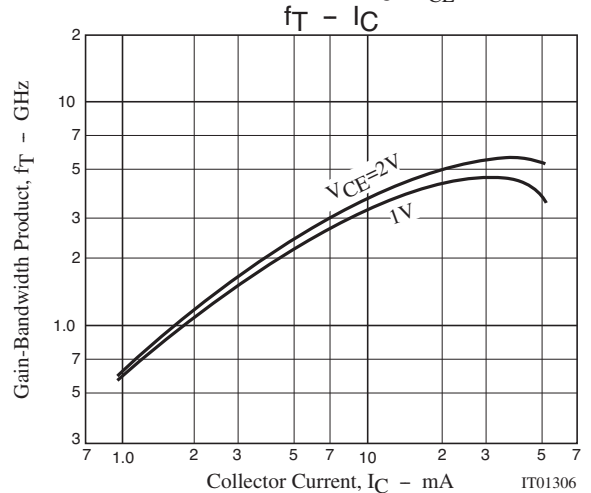
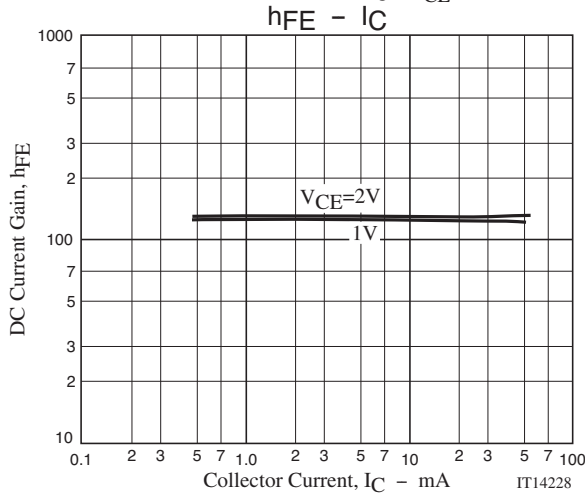
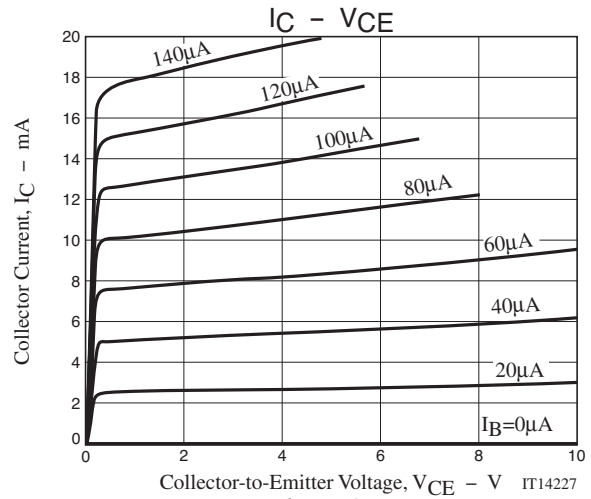
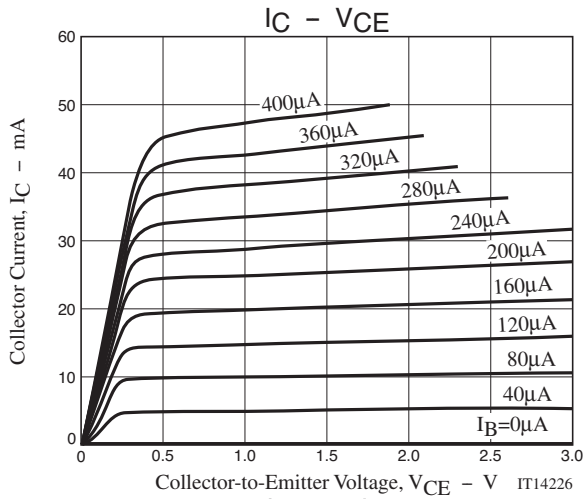

2SC5536A

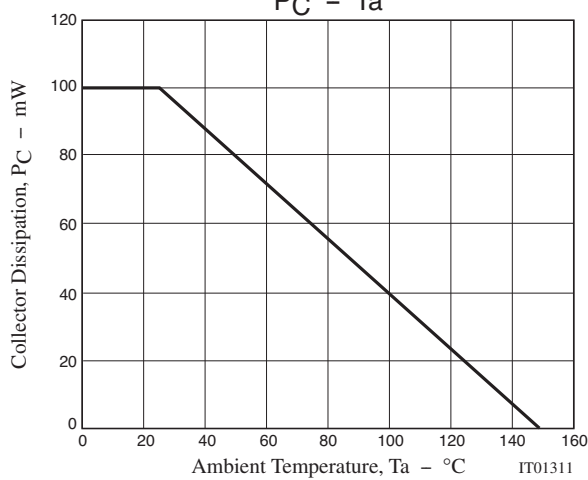
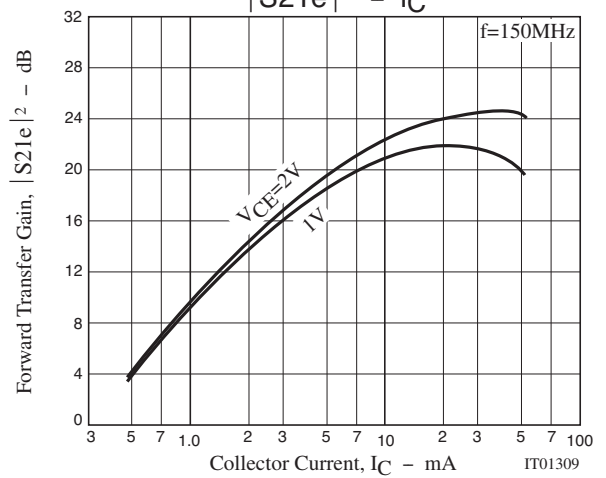
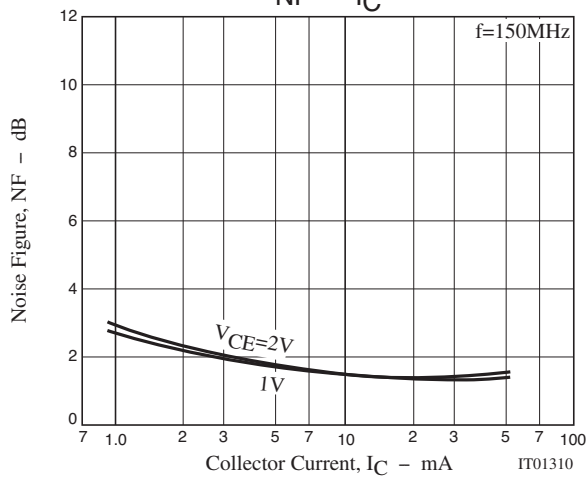
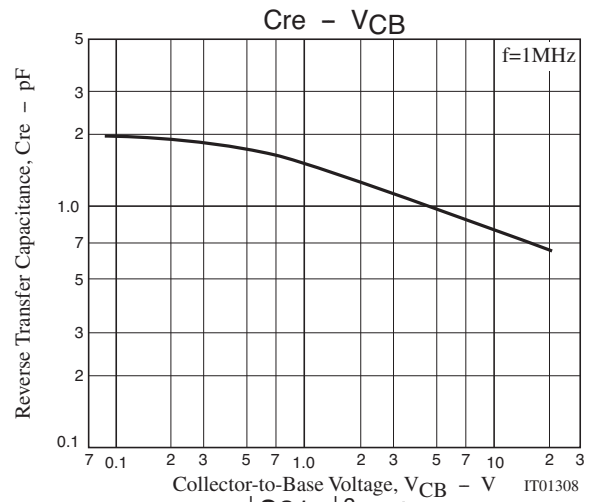
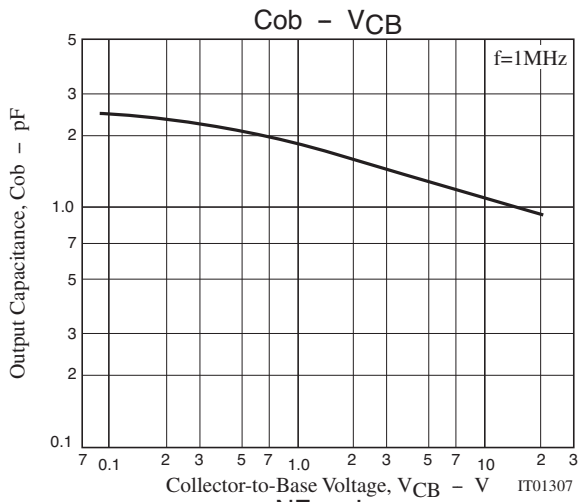

2SC5536A

S Parameters (Common emitter)

$V_{CE}=2V, I_C=1mA, Z_O=50\Omega$

Freq(MHz)	S11	$\angle S11$	S21	$\angle S21$	S12	$\angle S12$	S22	$\angle S22$
50	0.961	-26.3	3.67	162.9	0.040	74.8	0.980	-7.3
100	0.937	-52.0	2.90	148.5	0.074	61.5	0.938	-13.4
150	0.917	-72.8	2.69	135.6	0.099	50.4	0.890	-18.0
200	0.890	-89.5	2.47	125.0	0.114	41.3	0.843	-21.5
250	0.893	-100.7	2.23	116.6	0.124	33.8	0.803	-24.4
300	0.880	-111.3	1.93	108.8	0.130	28.3	0.785	-26.5
350	0.868	-122.4	1.83	102.9	0.135	23.9	0.747	-28.6
400	0.873	-127.6	1.58	96.8	0.136	19.9	0.747	-30.5
450	0.858	-135.4	1.52	92.7	0.137	16.8	0.720	-32.3
500	0.866	-138.9	1.31	87.3	0.135	14.0	0.724	-34.3

$V_{CE}=2V, I_C=3mA, Z_O=50\Omega$

Freq(MHz)	S11	$\angle S11$	S21	$\angle S21$	S12	$\angle S12$	S22	$\angle S22$
50	0.888	-37.5	9.15	157.9	0.038	69.9	0.942	-15.0
100	0.860	-68.6	8.01	140.2	0.064	54.0	0.829	-26.1
150	0.835	-91.8	6.76	127.0	0.080	43.3	0.723	-32.9
200	0.810	-108.7	5.56	117.8	0.088	35.6	0.636	-36.7
250	0.800	-121.4	4.93	110.1	0.095	30.8	0.581	-39.1
300	0.792	-130.6	4.17	104.6	0.098	27.4	0.533	-40.9
350	0.791	-137.9	3.73	98.9	0.098	24.8	0.510	-42.2
400	0.787	-143.8	3.28	95.2	0.100	23.0	0.482	-43.3
450	0.785	-148.4	2.99	91.0	0.098	22.2	0.472	-44.6
500	0.783	-152.5	2.69	88.1	0.100	21.3	0.457	-45.7

$V_{CE}=2V, I_C=10mA, Z_O=50\Omega$

Freq(MHz)	S11	$\angle S11$	S21	$\angle S21$	S12	$\angle S12$	S22	$\angle S22$
50	0.733	-64.8	22.70	145.6	0.031	60.7	0.825	-33.9
100	0.722	-105.2	16.71	125.0	0.046	44.9	0.605	-53.9
150	0.719	-126.7	12.55	113.3	0.052	38.2	0.462	-64.8
200	0.713	-139.6	9.94	106.2	0.055	36.3	0.371	-71.4
250	0.716	-147.8	8.10	101.0	0.059	35.6	0.314	-76.1
300	0.716	-153.8	6.88	96.9	0.060	36.2	0.276	-79.7
350	0.716	-158.8	5.96	93.4	0.062	37.4	0.248	-82.6
400	0.717	-162.1	5.25	90.7	0.065	38.6	0.228	-85.1
450	0.715	-165.3	4.70	88.2	0.067	40.6	0.215	-86.7
500	0.716	-167.6	4.24	85.9	0.069	42.1	0.204	-88.6

$V_{CE}=2V, I_C=30mA, Z_O=50\Omega$

Freq(MHz)	S11	$\angle S11$	S21	$\angle S21$	S12	$\angle S12$	S22	$\angle S22$
50	0.605	-104.0	36.87	131.9	0.022	54.3	0.672	-59.9
100	0.660	-137.6	23.04	112.9	0.030	44.3	0.450	-89.4
150	0.677	-151.7	16.23	104.1	0.034	45.3	0.352	-106.7
200	0.681	-159.5	12.43	99.4	0.038	47.4	0.302	-118.6
250	0.686	-164.5	10.04	95.6	0.042	50.8	0.276	-127.0
300	0.687	-168.1	8.44	92.8	0.045	53.9	0.260	-133.7
350	0.689	-170.8	7.27	90.2	0.050	56.5	0.251	-138.8
400	0.691	-173.0	6.38	88.3	0.055	58.3	0.244	-142.9
450	0.691	-174.8	5.70	86.4	0.059	60.5	0.239	-145.6
500	0.691	-176.5	5.14	84.7	0.064	61.5	0.237	-148.2

Embossed Taping Specification

2SC5536A-TL-H

1. Packing Format

Package Name	Carrier Tape Type	Maximum Number of devices contained (pcs)			Packing format	
		Reel	Inner box	Outer box	Inner BOX (C-1)	Outer BOX (A-7)
SSFP	SSFP	8,000	40,000	240,000	5 reels contained Dimensions:mm (external) 183×72×185	6 inner boxes contained Dimension::mm (external) 440×195×210

Packing method

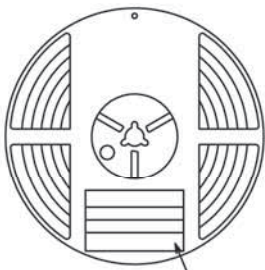

Reel label

Reel label, Inner box label (unit:mm)

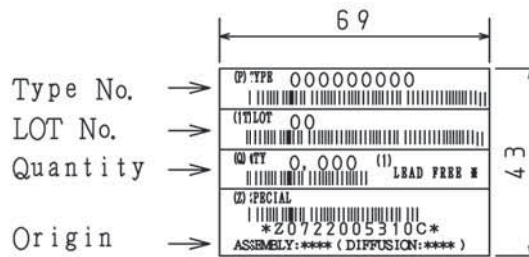

Outer box label
It is a label at the time of factory shipments. The form of a label may change in physical distribution process.

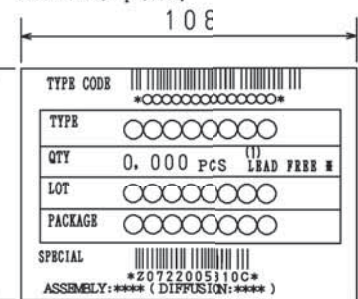

NOTE (1)

The LEAD FREE * description shows that the surface treatment of the terminal is lead free.

Label	JEITA Phase
LEAD FREE 3	JEITA Phase 3A
LEAD FREE 4	JEITA Phase 3

2. Taping configuration

2-1. Carrier tape size (unit:mm)

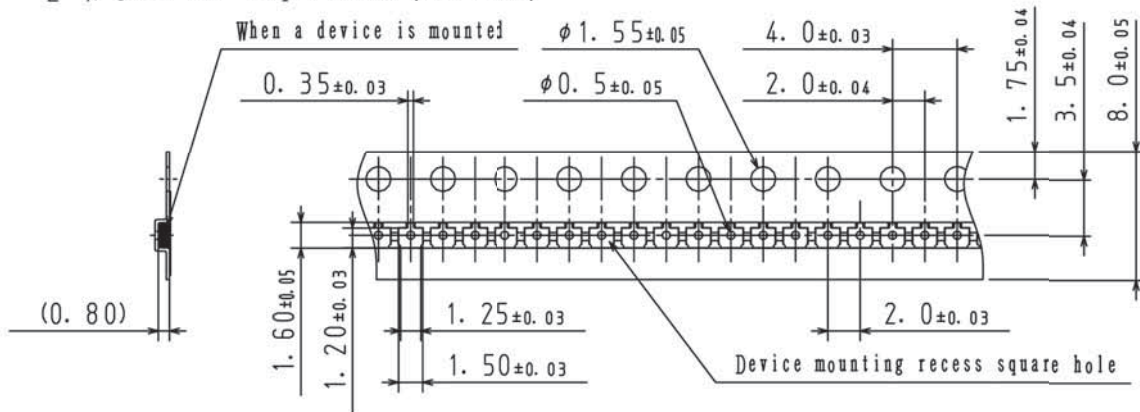

2-2. Device placement direction

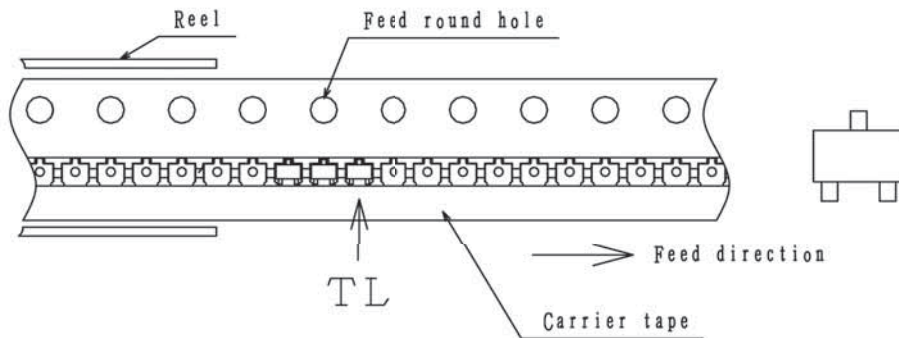

Those with pin 1 index on the feed hole side.....TL

2SC5536A

Outline Drawing

2SC5536A-TL-H

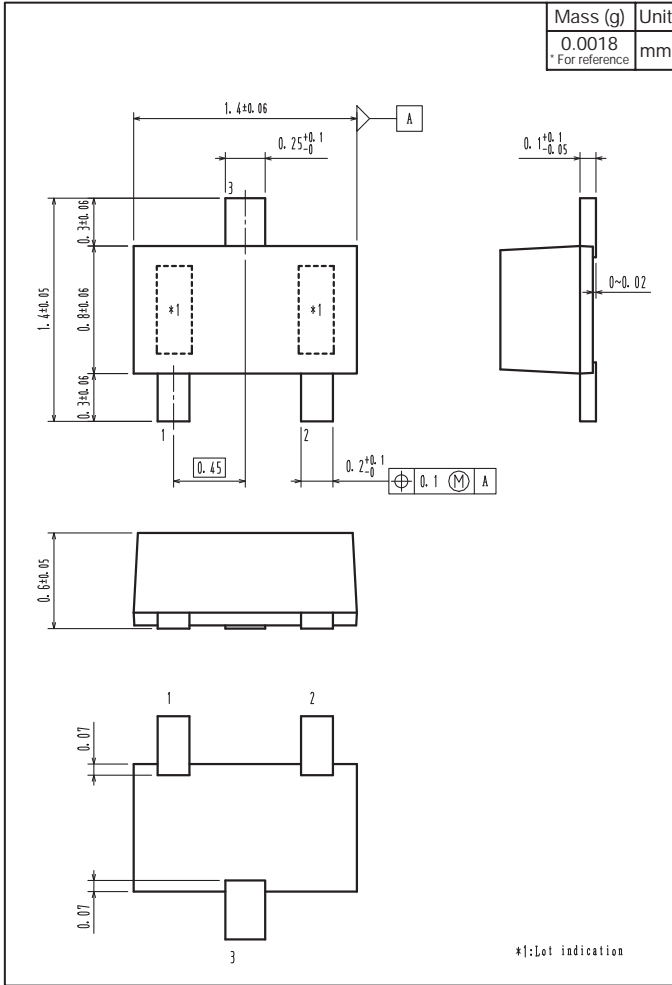

Land Pattern Example



- Any and all SANYO Semiconductor Co.,Ltd. products described or contained herein are, with regard to "standard application", intended for the use as general electronics equipment. The products mentioned herein shall not be intended for use for any "special application" (medical equipment whose purpose is to sustain life, aerospace instrument, nuclear control device, burning appliances, transportation machine, traffic signal system, safety equipment etc.) that shall require extremely high level of reliability and can directly threaten human lives in case of failure or malfunction of the product or may cause harm to human bodies, nor shall they grant any guarantee thereof. If you should intend to use our products for new introduction or other application different from current conditions on the usage of automotive device, communication device, office equipment, industrial equipment etc. , please consult with us about usage condition (temperature, operation time etc.) prior to the intended use. If there is no consultation or inquiry before the intended use, our customer shall be solely responsible for the use.
- Specifications of any and all SANYO Semiconductor Co.,Ltd. products described or contained herein stipulate the performance, characteristics, and functions of the described products in the independent state, and are not guarantees of the performance, characteristics, and functions of the described products as mounted in the customer's products or equipment. To verify symptoms and states that cannot be evaluated in an independent device, the customer should always evaluate and test devices mounted in the customer's products or equipment.
- SANYO Semiconductor Co.,Ltd. assumes no responsibility for equipment failures that result from using products at values that exceed, even momentarily, rated values (such as maximum ratings, operating condition ranges, or other parameters) listed in products specifications of any and all SANYO Semiconductor Co.,Ltd. products described or contained herein.
- Regarding monolithic semiconductors, if you should intend to use this IC continuously under high temperature, high current, high voltage, or drastic temperature change, even if it is used within the range of absolute maximum ratings or operating conditions, there is a possibility of decrease reliability. Please contact us for a confirmation.
- SANYO Semiconductor Co.,Ltd. strives to supply high-quality high-reliability products, however, any and all semiconductor products fail or malfunction with some probability. It is possible that these probabilistic failures or malfunction could give rise to accidents or events that could endanger human lives, trouble that could give rise to smoke or fire, or accidents that could cause damage to other property. When designing equipment, adopt safety measures so that these kinds of accidents or events cannot occur. Such measures include but are not limited to protective circuits and error prevention circuits for safe design, redundant design, and structural design.
- In the event that any or all SANYO Semiconductor Co.,Ltd. products described or contained herein are controlled under any of applicable local export control laws and regulations, such products may require the export license from the authorities concerned in accordance with the above law.
- No part of this publication may be reproduced or transmitted in any form or by any means, electronic or mechanical, including photocopying and recording, or any information storage or retrieval system, or otherwise, without the prior written consent of SANYO Semiconductor Co.,Ltd.
- Any and all information described or contained herein are subject to change without notice due to product/technology improvement, etc. When designing equipment, refer to the "Delivery Specification" for the SANYO Semiconductor Co.,Ltd. product that you intend to use.
- Upon using the technical information or products described herein, neither warranty nor license shall be granted with regard to intellectual property rights or any other rights of SANYO Semiconductor Co.,Ltd. or any third party. SANYO Semiconductor Co.,Ltd. shall not be liable for any claim or suits with regard to a third party's intellectual property rights which has resulted from the use of the technical information and products mentioned above.

This catalog provides information as of July, 2012. Specifications and information herein are subject to change without notice.