

Directional Couplers

DBTC-9-4-75+ DBTC-9-4-75L+

75Ω, 9dB Coupling, 5 to 1200 MHz

Maximum Ratings

Operating Temperature	-40°C to 85°C
Storage Temperature	-55°C to 100°C

Pin Connections

INPUT	3
OUTPUT	4
COUPLED	1
GROUND	2
ISOLATE (DO NOT USE)	6

Outline Drawing / Dimensions (inch/mm)

AT790-1 (DBTC-9-4-75)

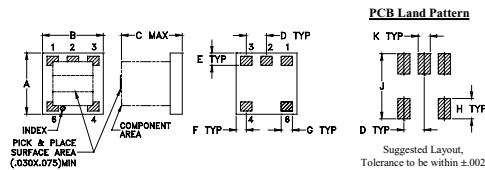

A	B	C	D	E	F	G	H	J	K	wt
.150	.150	.150	.050	.030	.025	.028	.050	.160	.030	grams
3.81	3.81	3.81	1.27	0.76	0.64	0.71	1.27	4.06	0.76	0.10

AT1030 (DBTC-9-4-75L)

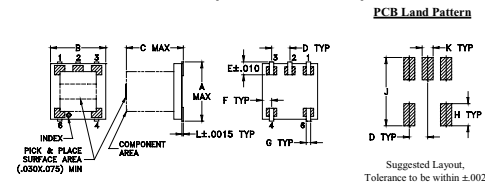

A	B	C	D	E	F	G	H	J	K	L	wt
.166	.150	.155	.050	.037	.025	.012	.060	.184	.030	.004	grams
4.22	3.81	3.94	1.27	0.94	0.64	0.30	1.52	4.67	0.76	0.10	0.10

Demo Board MCL P/N: TB-279 Suggested PCB Layout (PL-151)

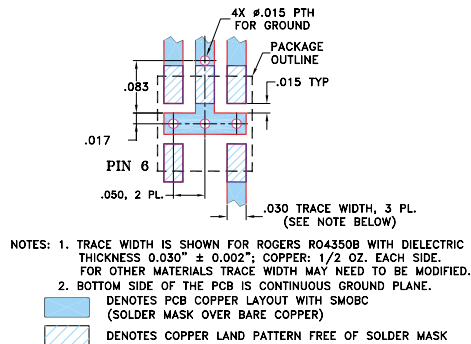

Features

- very flat coupling
- very broadband, multi octave
- temperature stable, LTCC base
- all welded construction
- leads attached for better solderability
- micro miniature coupler
- aqueous washable
- protected by US Patents 6,140,887 & 6,784,521

Applications

- CATV
- wire-line broadband access

Electrical Specifications

FREQ. (MHz)	COUPLING (dB)		MAINLINE LOSS (dB)		DIRECTIVITY (dB)		VSWR (:1)	POWER INPUT (W)
	Nom.	Max. Flatness	Typ.	Max.	Typ.	Min.		
5-1200	9.3±0.5	±0.7						
5-50			1.3	1.8	20	16	1.3	0.5
50-500			1.4	1.9	19	16	1.4	0.5
500-1000			1.5	2.1	18	15	1.6	0.5
1000-1200			1.8	2.4	17	12	1.8	0.5

Typical Performance Data

Frequency (MHz)	Mainline Loss (dB)		Coupling (dB) In-Cpl	Directivity (dB)	Return Loss (dB)		
	In-Out	In-Cpl			In	Out	Cpl
5.00	1.30	8.95	20.16	17.86	27.44	17.79	
50.00	1.25	8.94	20.52	18.77	37.27	18.31	
180.00	1.35	9.04	19.88	18.21	24.64	15.38	
340.00	1.47	9.17	18.93	14.37	19.25	11.87	
500.00	1.59	9.31	18.17	12.71	15.89	9.41	
700.00	1.71	9.43	17.66	11.29	13.70	7.55	
850.00	1.79	9.50	17.84	10.98	12.74	6.68	
1000.00	1.85	9.50	18.18	11.17	12.00	6.13	
1100.00	1.94	9.53	18.33	10.61	11.44	5.87	
1200.00	2.05	9.55	18.17	10.64	10.96	5.66	

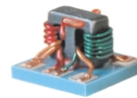
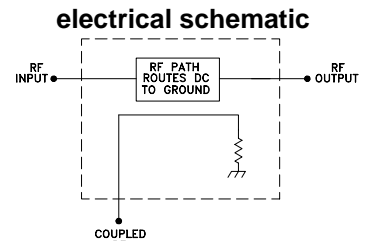
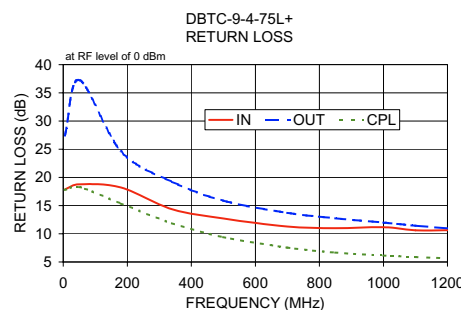
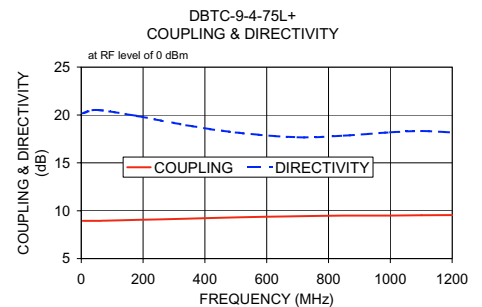
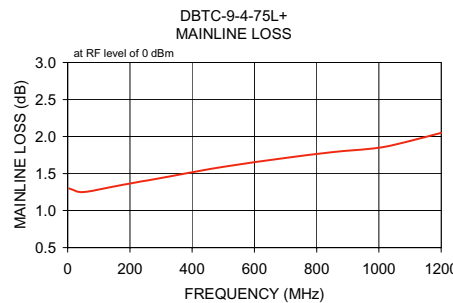

No Leads

CASE STYLE:AT790-1
PRICE: \$ 1.99 ea. QTY (25)
\$ 1.69 ea. QTY (1000)

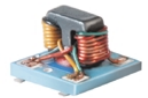

Leads

CASE STYLE:AT1030
PRICE: \$ 2.14 ea. QTY (25)
\$ 1.84 ea. QTY (1000)

+ RoHS compliant in accordance with EU Directive (2002/95/EC)

The +Suffix has been added in order to identify RoHS Compliance. See our web site for RoHS Compliance methodologies and qualifications.