

# Data Sheet

## Features

- For AMPS, CDMA and TDMA applications
- Usable bandwidth 25 MHz
- Low loss
- No impedance matching required for operation at 50 Ω
- Single-ended operation
- Ceramic Surface Mount Package (SMP)
- Small size

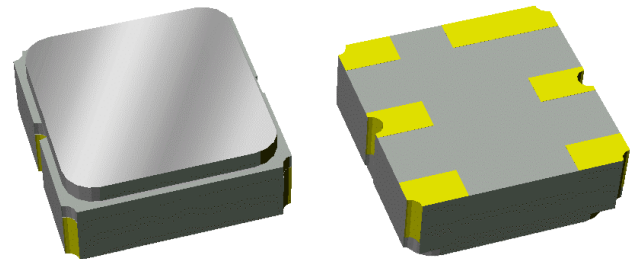

## Package

Surface Mount 3.0 x 3.0 x 1.22 mm

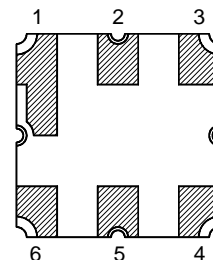
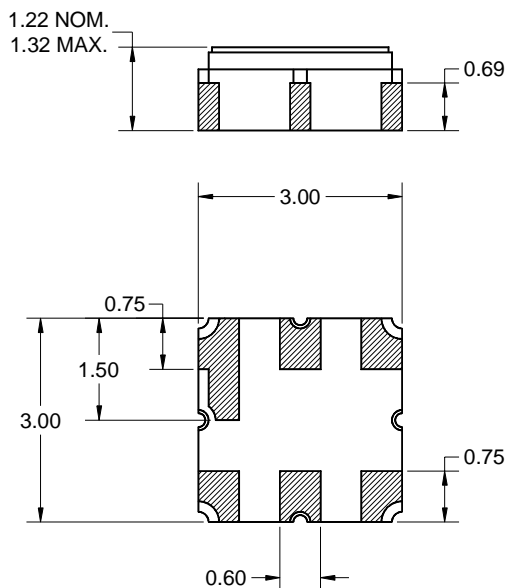

## Pin Configuration

Pin No.	Description
2,5	Input/Output
1,3,4,6	Case ground

Dimensions shown are nominal in millimeters  
 All tolerances are  $\pm 0.15$ mm except overall  
 length and width  $\pm 0.10$ mm

Body:  $Al_2O_3$  ceramic  
 Lid: Kovar, Ni plated  
 Terminations: Au plating 0.5 - 1.0 $\mu$ m,  
 over a 2 - 6 $\mu$ m Ni plating

# Data Sheet

## Electrical Specifications <sup>(1)</sup>

Operating Temperature Range: <sup>(2)</sup> -40 to +85 °C

Parameter <sup>(3)</sup>	Minimum	Typical	Maximum	Unit
<b>Center Frequency</b>	-	881.5	-	MHz
<b>Maximum Insertion Loss</b> 869 - 894 MHz	-	1.8	3	dB
<b>Amplitude Variation</b> 869 - 894 MHz	-	0.6	1.8	dB p-p
<b>Absolute Attenuation</b> 10 - 800 MHz	20	34	-	dB
824 - 849 MHz	35	38	-	dB
978 - 1006 MHz	25	35	-	dB
1088 - 1119 MHz	30	32	-	dB
1119 - 2600 MHz	20	30	-	dB
<b>Input/Output Return Loss</b> 869 - 894 MHz	10	12	-	dB
<b>Terminating Source Impedance:</b> <sup>(4)</sup>	-	50	-	Ω
<b>Terminating Load Impedance:</b> <sup>(4)</sup>	-	50	-	Ω
<b>Operating Temperature Range</b>	-40	25	+85	°C

**Notes:**

1. All specifications are based on the test circuit shown below
2. In production, devices will be tested at room temperature to a guardbanded specification to ensure electrical compliance over temperature
3. Electrical margin has been built into the design to account for the variations due to temperature drift and manufacturing tolerances
4. This is the optimum impedance in order to achieve the performance shown

**Test Circuit:**

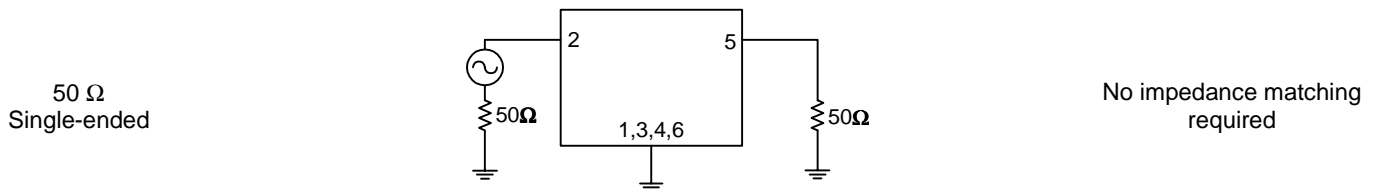

**Data Sheet**

**Typical Performance (at +25°C)**

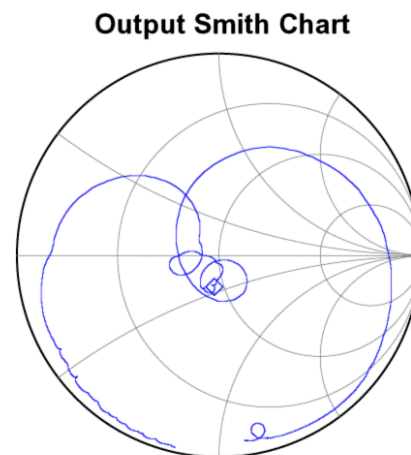
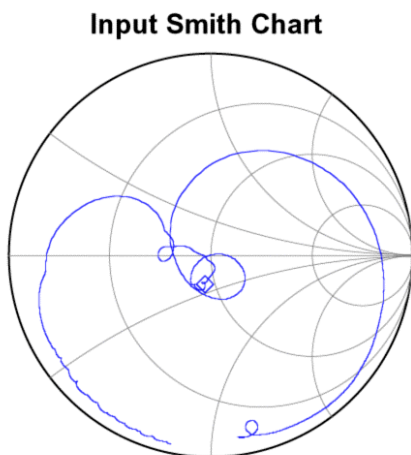
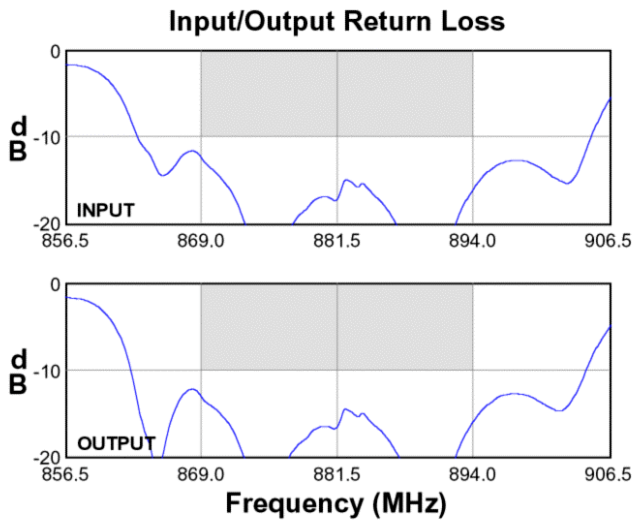
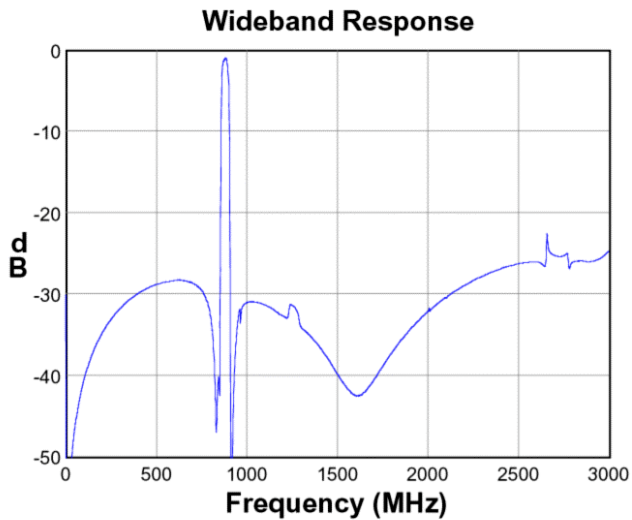
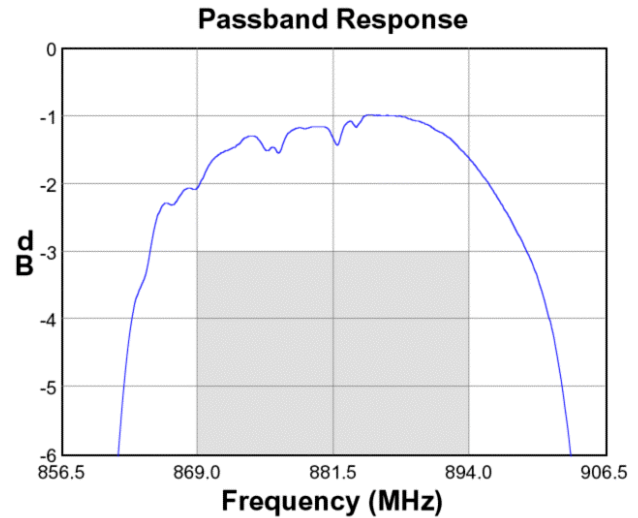
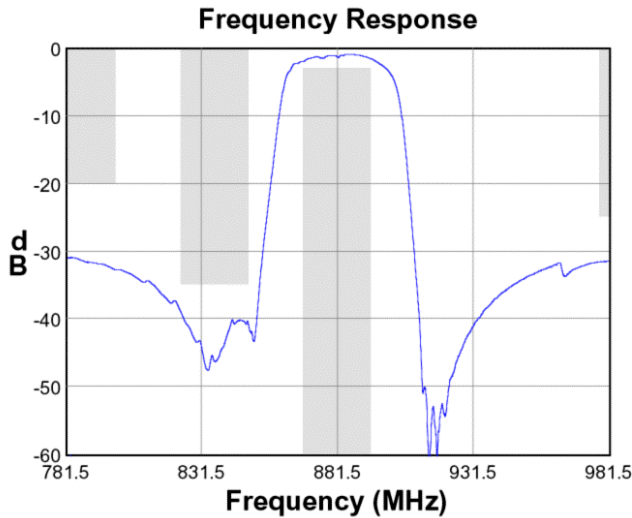

**Data Sheet**

**Matching Schematics**

50 Ω  
Single-ended

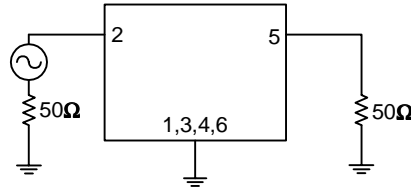

No impedance matching  
required

**Marking**

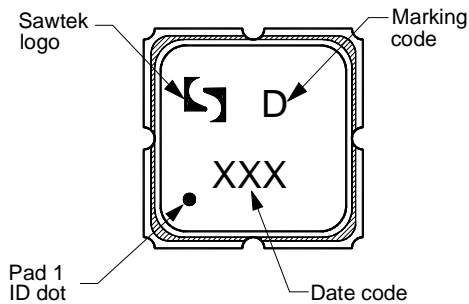

**PCB Footprint**

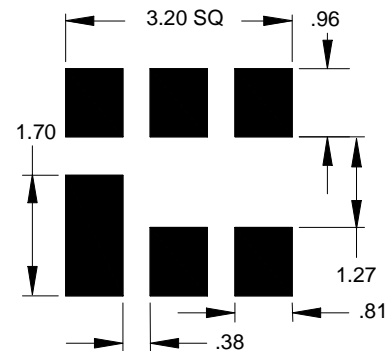

Date code is the day of the current year in 3-digit Julian format

This footprint represents a recommendation only  
Dimensions shown are nominal in millimeters

**Tape and Reel**

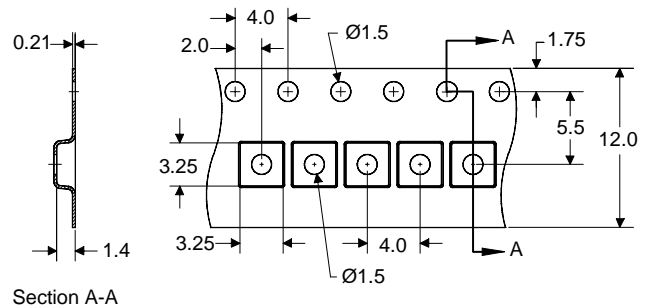
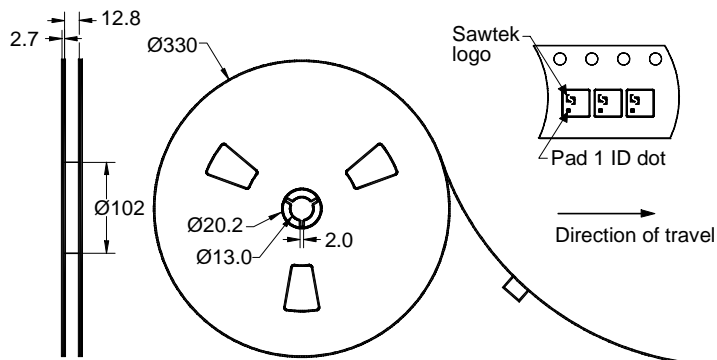

Dimensions shown are nominal in millimeters  
Packaging quantity: 5000 units/reel

# Data Sheet

## Maximum Ratings

Parameter	Symbol	Minimum	Maximum	Unit
Operating Temperature Range	T	-40	+85	°C
Storage Temperature Range	T <sub>stg</sub>	-40	+85	°C
RF Power	P <sub>in</sub>	-	+23	dBm

### Warnings

- Electrostatic Sensitive Device (ESD) 
- Avoid ultrasonic exposure

## Links to Additional Technical Information

[PCB Layout Tips](#)

[Qualification Flowchart](#)

[Soldering Profile](#)

[S-Parameters](#)

[Reel and Packaging Label](#)

[Other Technical Information](#)

## Contact Information



PO Box 609501  
 Orlando, FL 32860-9501  
 USA

Phone: +1 (407) 886-8860  
 Fax: +1 (407) 886-7061  
 Email: [custservice@sawtek.com](mailto:custservice@sawtek.com)  
 Web: [www.sawtek.com](http://www.sawtek.com)

Or contact one of our worldwide  
 network of [sales offices](#),  
[representatives or distributors](#)