

NX-Series CIB Module (3Ø Converter + 3Ø Inverter + Brake) 75 Amperes/600 Volts

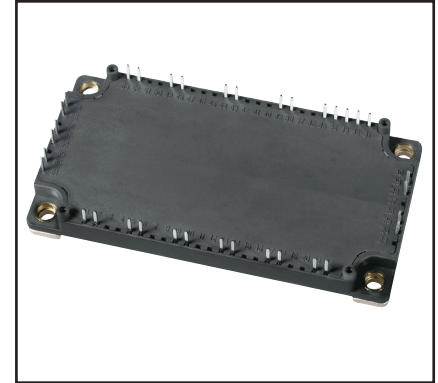
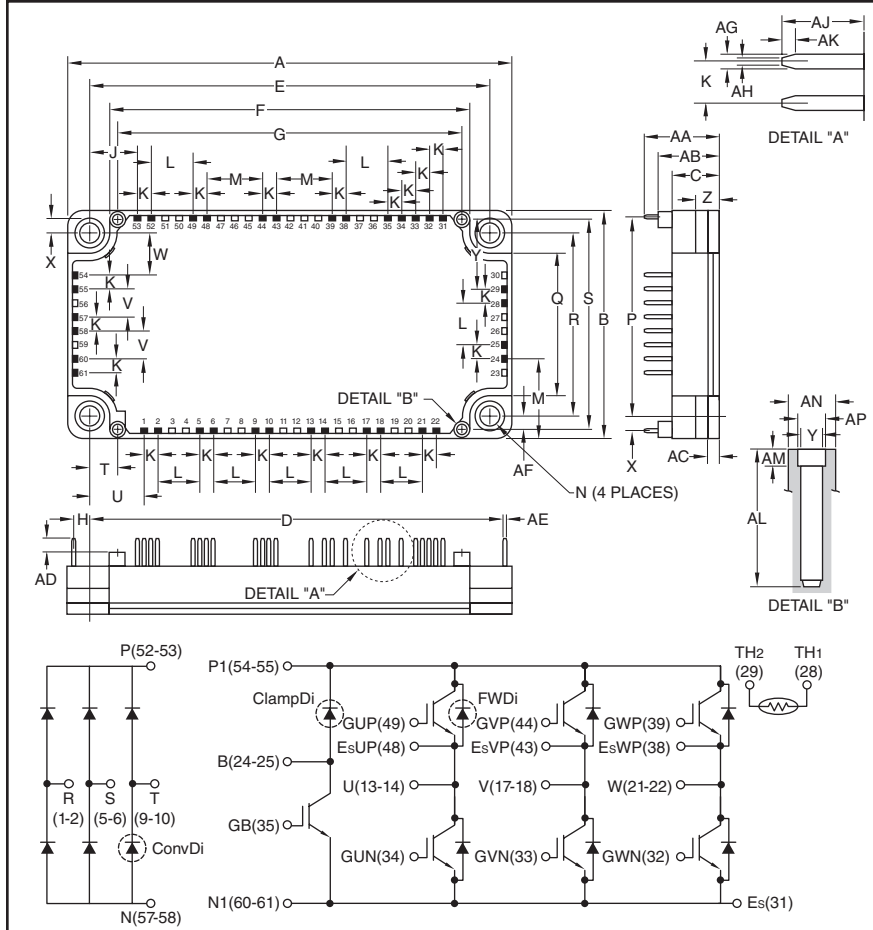

Description:

CIBs are low profile and thermally efficient. Each module consists of a three-phase diode converter section, a three-phase inverter section and a brake circuit. A thermistor is included in the package for sensing the baseplate temperature. 5th Generation CSTBT chips yield low loss.

Features:

- Low Drive Power
- Low $V_{CE(sat)}$
- Discrete Super-Fast Recovery Free-Wheel Diode
- Isolated Baseplate for Easy Heat Sinking

Applications:

- AC Motor Control
- Motion/Servo Control
- Photovoltaic/Fuel Cell

Ordering Information:

Example: Select the complete module number you desire from the table below -i.e. CM75MX-12A is a 600V (V_{CES}), 75 Ampere CIB Power Module.

Type	Current Rating Amperes	V_{CES} Volts (x 50)
CM	75	12

Outline Drawing and Circuit Diagram

Dimensions	Inches	Millimeters
A	4.79	121.7
B	2.44	62.0
C	0.51	13.0
D	4.49	114.05
E	4.33±0.02	110.0±0.5
F	3.89	99.0
G	3.72	94.5
H	0.16	4.06
J	0.51	13.09
K	0.15	3.81
L	0.45	11.43
M	0.6	15.24
N	0.22 Dia.	5.5 Dia.
P	2.13	54.2
Q	1.53	39.0
R	1.97±0.02	50.0±0.5
S	2.26	57.5
T	0.30	7.75
U	0.59	15.0

Dimensions	Inches	Millimeters
V	0.3	7.62
W	0.46	11.66
X	0.16	4.2
Y	0.08 Dia.	2.1 Dia.
Z	0.27	7.0
AA	0.81	20.5
AB	0.67	17.0
AC	0.12	3.0
AD	0.14	3.5
AE	0.03	0.8
AF	0.15	3.75
AG	0.05	1.15
AH	0.025	0.65
AJ	0.29	7.4
AK	0.047	1.2
AL	0.49	12.5
AM	0.06	1.5
AN	0.17 Dia.	4.3 Dia.
AP	0.10 Dia.	2.5 Dia.

CM75MX-12A
NX-Series CIB Module
(3Ø Converter + 3Ø Inverter + Brake)
 75 Amperes/600 Volts

Absolute Maximum Ratings, T_j = 25°C unless otherwise specified

Characteristics	Symbol	CM75MX-12A	Units
Inverter Part IGBT/FWDi			
Collector-Emitter Voltage (G-E Short)	V _{CES}	600	Volts
Gate-Emitter Voltage (C-E Short)	V _{GES}	±20	Volts
Collector Current (DC, T _C = 70°C) ^{*2,*4}	I _C	75	Amperes
Collector Current (Pulse) ^{*3}	I _{CRM}	150	Amperes
Total Power Dissipation (T _C = 25°C) ^{*2,*4}	P _{tot}	280	Watts
Emitter Current ^{*2}	I _E ^{*1}	75	Amperes
Emitter Current (Pulse) ^{*3}	I _{ERM} ^{*1}	150	Amperes

Brake Part IGBT/ClampDi

Collector-Emitter Voltage (G-E Short)	V _{CES}	600	Volts
Gate-Emitter Voltage (C-E Short)	V _{GES}	±20	Volts
Collector Current (DC, T _C = 97°C) ^{*2,*4}	I _C	50	Amperes
Collector Current (Pulse) ^{*3}	I _{CRM}	100	Amperes
Total Power Dissipation (T _C = 25°C) ^{*2,*4}	P _{tot}	280	Watts
Repetitive Peak Reverse Voltage	V _{RPM}	600	Volts
Forward Current (T _C = 25°C) ^{*2}	I _F	50	Amperes
Forward Current (Pulse) ^{*3}	I _{FRM}	100	Amperes

Converter Part ConvDi

Repetitive Peak Reverse Voltage	V _{RPM}	800	Volts
Recommended AC Input Voltage	E _a	220	Volts
DC Output Current (3-Phase Full Wave Rectifying, f = 60Hz, T _C = 125°C) ^{*2,*4}	I _O	75	Amperes
Surge Forward Current (Sine Half-wave 1 Cycle Peak Value, f = 60Hz, Non-repetitive)	I _{FSM}	750	Amperes
Current Square Time (Value for One Cycle of Surge Current)	I ² t	2340	A ² s

Module

Isolation Voltage (Charged Part to Baseplate, RMS, f = 60Hz, AC 1 min.)	V _{ISO}	2500	Volts
Junction Temperature	T _j	-40 ~ +150	°C
Storage Temperature	T _{stg}	-40 ~ +125	°C

*1 Represent ratings and characteristics of the anti-parallel, emitter-to-collector free wheeling diode (FWDi).
 *2 Junction temperature (T_j) should not increase beyond maximum junction temperature (T_{j(max)}) rating.
 *3 Pulse width and repetition rate should be such that device junction temperature (T_j) does not exceed T_{j(max)} rating.
 *4 Case temperature (T_C) and heatsink temperature (T_S) is measured on the surface (mounting side) of the baseplate and the heatsink side just under the chips. Refer to the figure to the right for chip location.
 The heatsink thermal resistance should be measured just under the chips.

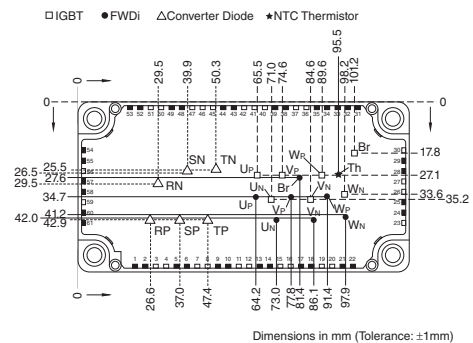

CM75MX-12A
NX-Series CIB Module
(3Ø Converter + 3Ø Inverter + Brake)
 75 Amperes/600 Volts

Electrical Characteristics, $T_j = 25^\circ\text{C}$ unless otherwise specified

Inverter Part IGBT/FWDi

Characteristics	Symbol	Test Conditions	Min.	Typ.	Max.	Units	
Collector Cutoff Current	I_{CES}	$V_{CE} = V_{CES}, V_{GE} = 0V$	—	—	1.0	mA	
Gate Leakage Current	I_{GES}	$V_{GE} = V_{GES}, V_{CE} = 0V$	—	—	0.5	μA	
Gate-Emitter Threshold Voltage	$V_{GE(th)}$	$I_C = 7.5\text{mA}, V_{CE} = 10V$	5	6	7	Volts	
Collector-Emitter Saturation Voltage	$V_{CE(sat)}$	$T_j = 25^\circ\text{C}, I_C = 75\text{A}, V_{GE} = 15V^{*5}$	—	1.7	2.1	Volts	
		$T_j = 125^\circ\text{C}, I_C = 75\text{A}, V_{GE} = 15V^{*5}$	—	1.9	—	Volts	
		$I_C = 75\text{A}, V_{GE} = 15V, \text{Chip}^{*5}$	—	1.6	—	Volts	
Input Capacitance	C_{ies}		—	—	7.5	nF	
Output Capacitance	C_{oes}	$V_{CE} = 10V, V_{GE} = 0V$	—	—	1.0	nF	
Reverse Transfer Capacitance	C_{res}		—	—	0.3	nF	
Total Gate Charge	Q_G	$V_{CC} = 300V, I_C = 75\text{A}, V_{GE} = 15V$	—	200	—	nC	
Inductive Load Switch Time	Turn-on Delay Time	$t_{d(on)}$	—	—	100	ns	
	Turn-on Rise Time	t_r	$V_{CC} = 300V, I_C = 75\text{A}, V_{GE} = \pm 15V,$	—	—	100	ns
	Turn-off Delay Time	$t_{d(off)}$	$R_G = 8.2\Omega, \text{Inductive Load}$	—	—	300	ns
	Turn-off Fall Time	t_f		—	—	600	ns
Emitter-Collector Voltage	V_{EC}^{*1}	$T_j = 25^\circ\text{C}, I_E = 75\text{A}, V_{GE} = 0V^{*5}$	—	2.0	2.8	Volts	
		$T_j = 125^\circ\text{C}, I_E = 75\text{A}, V_{GE} = 0V^{*5}$	—	1.95	—	Volts	
		$I_E = 75\text{A}, V_{GE} = 0V, \text{Chip}$	—	1.9	—	Volts	
Reverse Recovery Time	t_{rr}^{*1}	$V_{CC} = 300V, I_E = 75\text{A}, V_{GE} = \pm 15V$	—	—	200	ns	
Reverse Recovery Charge	Q_{rr}^{*1}	$R_G = 8.2\Omega, \text{Inductive Load}$	—	1.8	—	μC	
Internal Gate Resistance	r_g	$T_C = 25^\circ\text{C}, \text{Per Switch}$	—	0	—	Ω	
External Gate Resistance	R_G		8.0	—	83	Ω	

*1 Represent ratings and characteristics of the anti-parallel, emitter-to-collector free wheeling diode (FWDi).

*5 Pulse width and repetition rate should be such as to cause negligible temperature rise.

CM75MX-12A
NX-Series CIB Module
(3Ø Converter + 3Ø Inverter + Brake)
 75 Amperes/600 Volts

Electrical Characteristics, $T_j = 25^\circ\text{C}$ unless otherwise specified

Characteristics	Symbol	Test Conditions	Min.	Typ.	Max.	Units
Brake Part IGBT/ClampDi						
Collector Cutoff Current	I_{CES}	$V_{CE} = V_{CES}, V_{GE} = 0V$	—	—	1.0	mA
Gate Leakage Current	I_{GES}	$V_{GE} = V_{GES}, V_{CE} = 0V$	—	—	0.5	μA
Gate-Emitter Threshold Voltage	$V_{GE(th)}$	$I_C = 5\text{mA}, V_{CE} = 0V$	5	6	7	Volts
Collector-Emitter Saturation Voltage	$V_{CE(sat)}$	$T_j = 25^\circ\text{C}, I_C = 50\text{A}, V_{GE} = 15V^{*5}$	—	1.7	2.1	Volts
		$T_j = 125^\circ\text{C}, I_C = 50\text{A}, V_{GE} = 15V^{*5}$	—	1.9	—	Volts
		$I_C = 50\text{A}, V_{GE} = 15V$, Chip	—	1.6	—	Volts
Input Capacitance	C_{ies}		—	—	9.3	nF
Output Capacitance	C_{oes}	$V_{CE} = 10V, V_{GE} = 0V$	—	—	1.0	nF
Reverse Transfer Capacitance	C_{res}		—	—	0.3	nF
Total Gate Charge	Q_G	$V_{CC} = 300V, I_C = 50\text{A}, V_{GE} = 15V$	—	200	—	nC
Internal Gate Resistance	r_g	$T_C = 25^\circ\text{C}$	—	0	—	Ω
Repetitive Reverse Current	I_{RRM}	$V_R = V_{RRM}$	—	—	1.0	mA
Forward Voltage Drop	V_F	$T_j = 25^\circ\text{C}, I_F = 50A^{*5}$	—	2.0	2.8	Volts
		$T_j = 125^\circ\text{C}, I_F = 50A^{*5}$	—	1.95	—	Volts
		$I_F = 50\text{A}$, Chip	—	1.9	—	Volts
External Gate Resistance	R_G		13	—	125	Ω

Converter Part

Repetitive Peak Reverse Current	I_{RRM}	$V_R = V_{RRM}, T_j = 150^\circ\text{C}$	—	—	20	mA
Forward Voltage Drop	V_F	$I_F = 75A^{*5}$	—	1.2	1.6	Volts

NTC Thermistor Part

Zero Power Resistance	R_{25}	$T_C = 25^\circ\text{C}^{*4}$	4.85	5.00	5.15	k Ω
Deviation of Resistance	$\Delta R/R$	$R_{100} = 493\Omega, T_C = 100^\circ\text{C}^{*4}$	-7.3	—	+7.8	%
B Constant	$B_{(25/50)}$	Approximate by Equation ^{*6}	—	3375	—	K
Power Dissipation	P_{25}	$T_C = 25^\circ\text{C}^{*4}$	—	—	10	mW

*4 Case temperature (T_C) and heatsink temperature (T_s) is measured on the surface (mounting side) of the baseplate and the heatsink side just under the chips. Refer to the figure to the right for chip location. The heatsink thermal resistance should be measured just under the chips.

*5 Pulse width and repetition rate should be such as to cause negligible temperature rise.

$$*6 B_{(25/50)} = \ln\left(\frac{R_{25}}{R_{50}}\right) / \left(\frac{1}{T_{25}} - \frac{1}{T_{50}}\right)$$

R_{25} : Resistance at Absolute Temperature T_{25} [K]; $T_{25} = 25 [^\circ\text{C}] + 273.15 = 298.15$ [K]

R_{50} : Resistance at Absolute Temperature T_{50} [K]; $T_{50} = 50 [^\circ\text{C}] + 273.15 = 323.15$ [K]

□ IGBT ● FWDI △ Converter Diode ★ NTC Thermistor

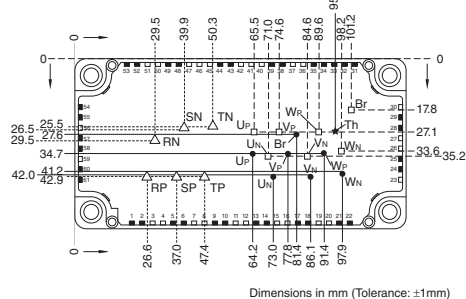

CM75MX-12A
NX-Series CIB Module
(3Ø Converter + 3Ø Inverter + Brake)
 75 Amperes/600 Volts

Thermal Resistance Characteristics, $T_j = 25^\circ\text{C}$ unless otherwise specified

Characteristics	Symbol	Test Conditions	Min.	Typ.	Max.	Units
Thermal Resistance, Junction to Case	$R_{th(j-c)Q}$	Per Inverter IGBT ^{*4}	—	—	0.44	$^\circ\text{C/W}$
Thermal Resistance, Junction to Case	$R_{th(j-c)D}$	Per Inverter FWDi ^{*4}	—	—	0.85	$^\circ\text{C/W}$
Thermal Resistance, Junction to Case	$R_{th(j-c)Q}$	Brake IGBT ^{*4}	—	—	0.44	$^\circ\text{C/W}$
Thermal Resistance, Junction to Case	$R_{th(j-c)D}$	Brake ClampDi ^{*4}	—	—	0.85	$^\circ\text{C/W}$
Thermal Resistance, Junction to Case	$R_{th(j-c)D}$	Per ConvDi ^{*4}	—	—	0.24	$^\circ\text{C/W}$
Contact Thermal Resistance	$R_{th(c-s)}$	Case to Heatsink, Per 1 Module Thermal Grease Applied ^{*4, *7}	—	0.015	—	$^\circ\text{C/W}$

Mechanical Characteristics

Characteristics	Symbol	Test Conditions	Min.	Typ.	Max.	Units
Mounting Torque, M5 Mounting Screws	—	—	—	31	—	in-lb
Module Weight (Typical)	—	—	—	270	—	Grams
Isolation Voltage, (Charged Part to Baseplate, RMS, f = 60Hz, AC 1 min.)	V_{ISO}	—	—	2500	—	Volts
Flatness of Baseplate ^{*8}	e_c	—	—	± 0 to +100	—	μm

^{*4} Case temperature (T_C) and heatsink temperature (T_S) is measured on the surface (mounting side) of the baseplate and the heatsink side just under the chips. Refer to the figure to the right for chip location.

The heatsink thermal resistance should be measured just under the chips.

^{*7} Typical value is measured by using thermally conductive grease of $\lambda = 0.9 \text{ [W/(m} \cdot \text{K)]}$.

^{*8} Baseplate (mounting side) flatness measurement points (X, Y) are shown in the figure below.

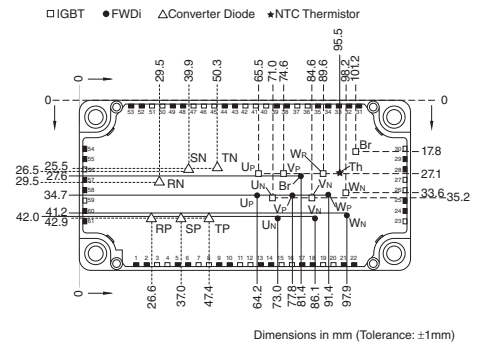
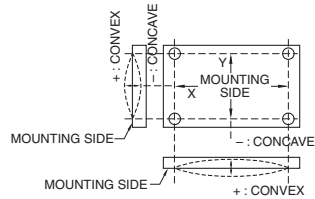

CM75MX-12A
NX-Series CIB Module
(3Ø Converter + 3Ø Inverter + Brake)
75 Amperes/600 Volts

OUTPUT CHARACTERISTICS
(INVERTER PART - TYPICAL)

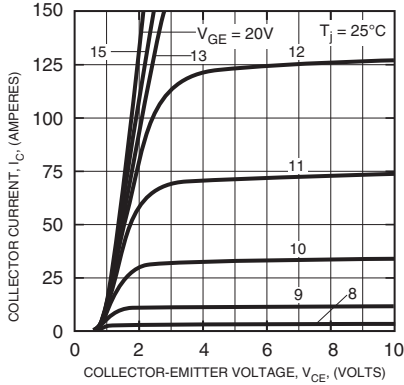

COLLECTOR-EMITTER SATURATION VOLTAGE CHARACTERISTICS
(INVERTER PART - TYPICAL)

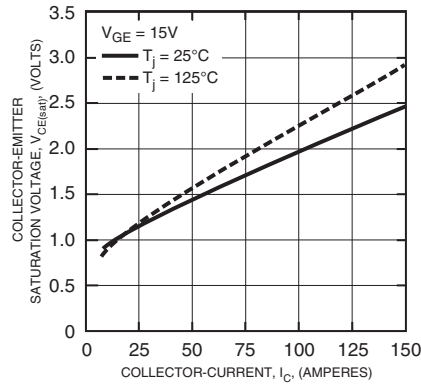

COLLECTOR-EMITTER SATURATION VOLTAGE CHARACTERISTICS
(INVERTER PART - TYPICAL)

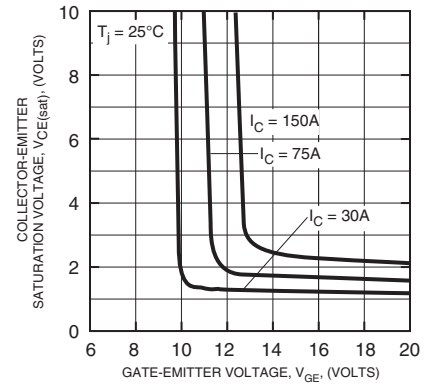

FREE-WHEEL DIODE FORWARD CHARACTERISTICS
(INVERTER PART - TYPICAL)

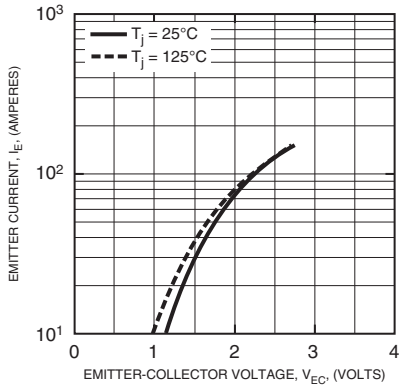

CAPACITANCE VS. V_CE
(INVERTER PART - TYPICAL)

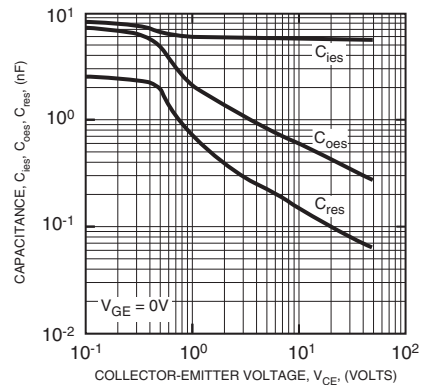

HALF-BRIDGE SWITCHING CHARACTERISTICS
(INVERTER PART - TYPICAL)

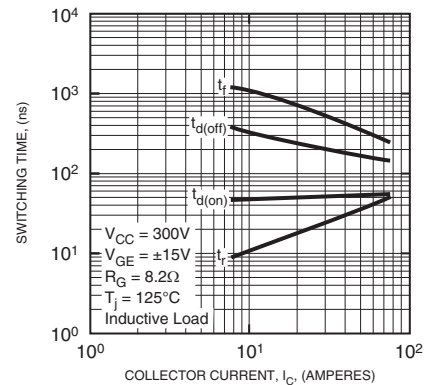

SWITCHING TIME VS. GATE RESISTANCE
(INVERTER PART - TYPICAL)

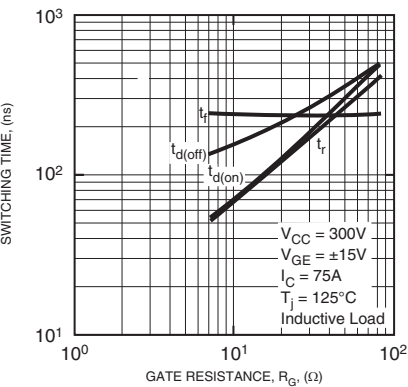

REVERSE RECOVERY CHARACTERISTICS
(INVERTER PART - TYPICAL)

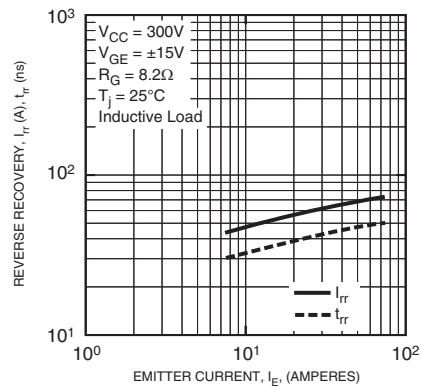

GATE CHARGE VS. V_GE
(INVERTER PART)

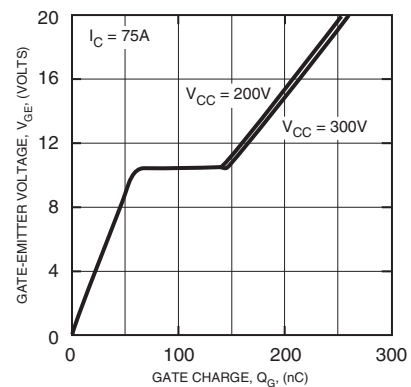



Powerex, Inc., 173 Pavilion Lane, Youngwood, Pennsylvania 15697 (724) 925-7272 www.pwr.com

CM75MX-12A
NX-Series CIB Module
(3Ø Converter + 3Ø Inverter + Brake)
75 Amperes/600 Volts

