

ELM91xxxxA CMOS PFM Step-up DC/DC converter and controller

<http://www.elm-tech.com>

■General description

ELM91xx1xA is CMOS PFM control step-up DC-DC converter; ELM91xx3xA is CMOS PFM control step-up DC-DC controller, which has large output current capacity by using an external FET switch. ELM91 series consists of reference voltage source, error amplifier, oscillation circuit, start-up circuit, PFM-control circuit, switching current limit circuit (ELM91xx1xA only), switching transistor (ELM91xx1xA only) and output voltage setting resistor. For external parts, coil, diode, MOSFET and capacitor are possible choices. The standard output voltages are 1.8V,3.0V,3.3V,5.0V; ELM91 series can also be designed as semi-custom IC within the range of 1.8V to 5.5V by 0.1V step.

■Features

- Output voltage range : 1.8V to 5.5V (by 0.1V)
- Low voltage operation : 0.9V(ELM91xx1xA: Iout=1mA)
- Oscillating frequency : Typ.100kHz
- Low power operation : Typ.40μW(ELM91301xA: Typ.100kHz)
- High efficiency : 85%(ELM9130xxA: Vin=1.5V, Iout=10mA)
- Output current(e.g.) : 100mA(Vin=1.5V, Vout=3.0V)
- Package : SOT-89, SOT-23, SC-70-5(SOT-353)

■Application

- Constant voltage source for battery-operated devices
- Portable communication equipments and video recorders

■Maximum absolute ratings

Parameter	Symbol	Limit	Unit
Apply voltage to LX pin	Vlx	Vss-0.3 to 7.0	V
Apply voltage to VOUT pin	Vout	Vss-0.3 to 7.0	V
Output current of LX pin	Ilx	500	mA
Output current of EXT pin	Iext	20	mA
Power dissipation	Pd	500 (SOT-89)	mW
		250 (SOT-23)	
		150 (SC-70-5)(SOT-353)	
Operating temperature	Top	-40 to +85	°C
Storage temperature	Tstg	-55 to +125	°C

■Selection guide

ELM91xxxxA-x

Symbol		
a, b	Output voltage	e.g. : 18: Vout=1.8V 30: Vout=3.0V 33: Vout=3.3V 50: Vout=5.0V
c	Switching transistor	1: Internal switch 3: External switch
d	Package	A: SOT-89 B: SOT-23 C: SC-70-5(SOT-353)
e	Product version	A
f	Taping direction	S, N: Refer to PKG file

ELM91 x x x x A - x
 ↑ ↑ ↑ ↑ ↑ ↑
 a b c d e f

ELM91xxxxA CMOS PFM Step-up DC/DC converter and controller

<http://www.elm-tech.com>

Pin configuration

SOT-89(TOP VIEW)

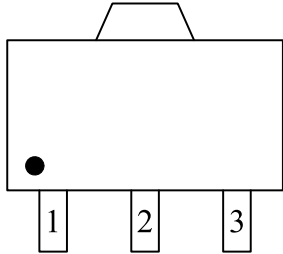

SOT-23(TOP VIEW)

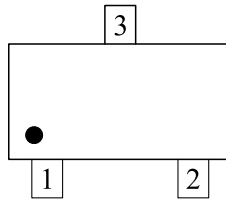

SC-70-5(TOP VIEW)

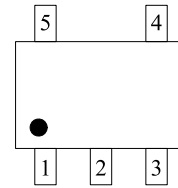

ELM91xxxAA

Pin No.	Pin name
1	VSS
2	VOUT
3	ELM91xx1AA: LX ELM91xx3AA: EXT

ELM91xxxBA

Pin No.	Pin name
1	VSS
2	ELM91xx1BA: LX ELM91xx3BA: EXT
3	VOUT

ELM91xxxCA

Pin No.	Pin name
1	NC
2	VOUT
3	NC
4	VSS
5	LX, EXT

Standard circuit

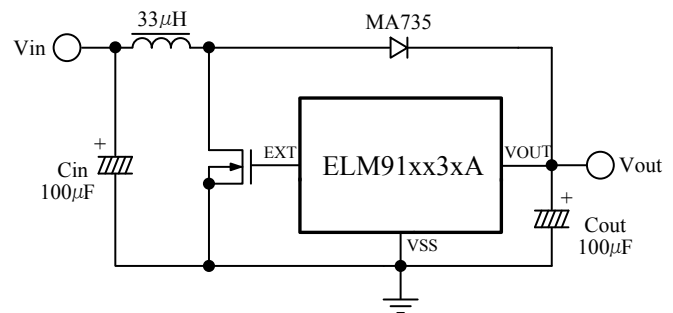
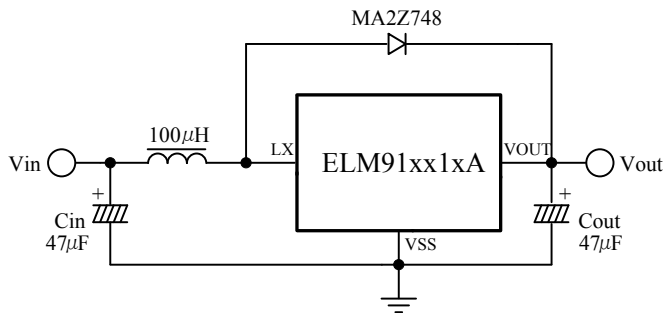

Block diagram

ELM91xx1xA

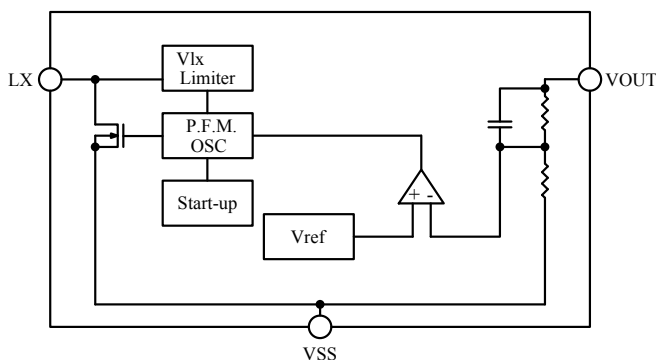

ELM91xx3xA

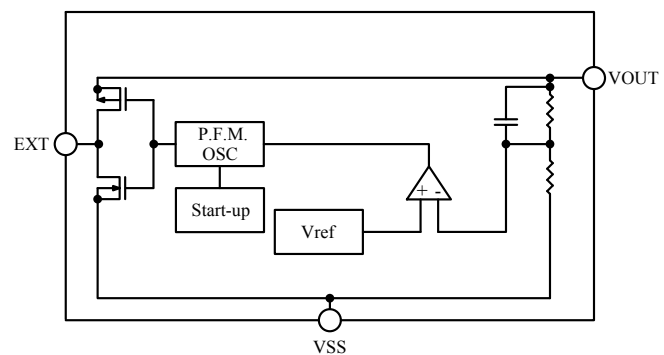

ELM91xxxxA CMOS PFM Step-up DC/DC converter and controller

<http://www.elm-tech.com>

■Electrical characteristics (ELM91xx1xA)

ELM91181xA

L=100μH, Cin=Cout=47μF, D=MA2Z748, Vss=0V, Top=25°C

Parameter	Symbol	Condition	Min.	Typ.	Max.	Unit
Output voltage	Vout	Iout=1mA, Vin=1.5V	1.755	1.800	1.845	V
Input voltage	Vin		0.9		6.0	V
Starting voltage	Vst	Iout=1mA			0.9	V
Holding voltage	Vhold	Iout=1mA			0.7	V
Current consumption 1	Iss1	Vout=Vout(T)×0.95		10	25	μA
Current consumption 2	Iss2	Vout=Vout(T)+0.5V		2	5	μA
On-resistance of LX switch	Ron	Vout=Vout(T)×0.95		1.5	3.0	Ω
Leakage current of LX pin	Ilxl	Vout=Vlx=6V			1	μA
Oscillating frequency	Fosc	Vout=Vout(T)×0.95	80	100	120	kHz
Voltage limit of LX pin (LX switch ON)	Vlxlim	Vout=Vout(T)×0.95	0.5	0.7	0.9	V
Duty ratio	Duty	Vout=Vout(T)×0.95	67	75	83	%

* Vout: Input voltage to out pin; Vout(T): Typ. value of Vout.

ELM91301xA

L=100μH, Cin=Cout=47μF, D=MA2Z748, Vss=0V, Top=25°C

Parameter	Symbol	Condition	Min.	Typ.	Max.	Unit
Output voltage	Vout	Iout=1mA, Vin=1.5V	2.925	3.000	3.075	V
Input voltage	Vin		0.9		6.0	V
Starting voltage	Vst	Iout=1mA			0.9	V
Holding voltage	Vhold	Iout=1mA			0.7	V
Current consumption 1	Iss1	Vout=Vout(T)×0.95		14	35	μA
Current consumption 2	Iss2	Vout=Vout(T)+0.5V		2	5	μA
On-resistance of LX switch	Ron	Vout=Vout(T)×0.95		0.9	1.9	Ω
Leakage current of LX pin	Ilxl	Vout=Vlx=6V			1	μA
Oscillating frequency	Fosc	Vout=Vout(T)×0.95	80	100	120	kHz
Voltage limit of LX pin (LX switch ON)	Vlxlim	Vout=Vout(T)×0.95	0.5	0.7	0.9	V
Duty ratio	Duty	Vout=Vout(T)×0.95	67	75	83	%

* Vout: Input voltage to out pin; Vout(T): Typ. value of Vout.

ELM91331xA

L=100μH, Cin=Cout=47μF, D=MA2Z748, Vss=0V, Top=25°C

Parameter	Symbol	Condition	Min.	Typ.	Max.	Unit
Output voltage	Vout	Iout=1mA, Vin=1.5V	3.218	3.300	3.382	V
Input voltage	Vin		0.9		6.0	V
Starting voltage	Vst	Iout=1mA			0.9	V
Holding voltage	Vhold	Iout=1mA			0.7	V
Current consumption 1	Iss1	Vout=Vout(T)×0.95		15	35	μA
Current consumption 2	Iss2	Vout=Vout(T)+0.5V		2	5	μA
On-resistance of LX switch	Ron	Vout=Vout(T)×0.95		0.9	1.9	Ω
Leakage current of LX pin	Ilxl	Vout=Vlx=6V			1	μA
Oscillating frequency	Fosc	Vout=Vout(T)×0.95	80	100	120	kHz
Voltage limit of LX pin (LX switch ON)	Vlxlim	Vout=Vout(T)×0.95	0.5	0.7	0.9	V
Duty ratio	Duty	Vout=Vout(T)×0.95	67	75	83	%

* Vout: Input voltage to out pin; Vout(T): Typ. value of Vout.

ELM91xxxxA CMOS PFM Step-up DC/DC converter and controller

<http://www.elm-tech.com>

ELM91501xA

L=100μH, Cin=Cout=47μF, D=MA2Z748, Vss=0V, Top=25°C

Parameter	Symbol	Condition	Min.	Typ.	Max.	Unit
Output voltage	Vout	Iout=1mA, Vin=3V	4.875	5.000	5.125	V
Input voltage	Vin		0.9		6.0	V
Starting voltage	Vst	Iout=1mA			0.9	V
Holding voltage	Vhold	Iout=1mA			0.7	V
Current consumption 1	Iss1	Vout=Vout(T)×0.95		20	45	μA
Current consumption 2	Iss2	Vout=Vout(T)+0.5V		2	5	μA
On-resistance of LX switch	Ron	Vout=Vout(T)×0.95		0.7	1.5	Ω
Leakage current of LX pin	Ilx1	Vout=Vlx=6V			1	μA
Oscillating frequency	Fosc	Vout=Vout(T)×0.95	80	100	120	kHz
Voltage limit of LX pin (LX switch ON)	Vlxlim	Vout=Vout(T)×0.95	0.5	0.7	0.9	V
Duty ratio	Duty	Vout=Vout(T)×0.95	67	75	83	%

* Vout: Input voltage to out pin; Vout(T): Typ. value of Vout.

■Electrical characteristics (ELM91xx3xA)

ELM91183xA

FET=ELM37400FA, L=33μH, Cin=Cout=100μF, D=MA735, Vss=0V, Top=25°C

Parameter	Symbol	Condition	Min.	Typ.	Max.	Unit
Output voltage	Vout	Iout=1mA, Vin=1.5V	1.755	1.800	1.845	V
Input voltage	Vin		0.9		6.0	V
Starting voltage	Vst	Iout=1mA			1.1	V
Holding voltage	Vhold	Iout=1mA			0.7	V
Current consumption 1	Iss1	Vout=Vout(T)×0.95, EXT: No-Load		10	25	μA
Current consumption 2	Iss2	Vout=Vout(T)+0.5V		2	5	μA
On-resistance of EXT "High"	Rexth	Vout=Vout(T)×0.95, Vext=Vout-0.4V		90	170	Ω
On-resistance of EXT "Low"	Rextl	Vout=Vout(T)×0.95, Vext=0.4V		70	120	Ω
Oscillating frequency	Fosc	Vout=Vout(T)×0.95	80	100	120	kHz
Duty ratio	Duty	Vout=Vout(T)×0.95	67	75	83	%

* Vout: Input voltage to out pin; Vout(T): Typ. value of Vout.

ELM91303xA

FET=ELM37400FA, L=33μH, Cin=Cout=100μF, D=MA735, Vss=0V, Top=25°C

Parameter	Symbol	Condition	Min.	Typ.	Max.	Unit
Output voltage	Vout	Iout=1mA, Vin=1.5V	2.925	3.000	3.075	V
Input voltage	Vin		0.9		6.0	V
Starting voltage	Vst	Iout=1mA			1.1	V
Holding voltage	Vhold	Iout=1mA			0.7	V
Current consumption 1	Iss1	Vout=Vout(T)×0.95, EXT: No-Load		14	35	μA
Current consumption 2	Iss2	Vout=Vout(T)+0.5V		2	5	μA
On-resistance of EXT "High"	Rexth	Vout=Vout(T)×0.95, Vext=Vout-0.4V		50	86	Ω
On-resistance of EXT "Low"	Rextl	Vout=Vout(T)×0.95, Vext=0.4V		36	60	Ω
Oscillating frequency	Fosc	Vout=Vout(T)×0.95	80	100	120	kHz
Duty ratio	Duty	Vout=Vout(T)×0.95	67	75	83	%

* Vout: Input voltage to out pin; Vout(T): Typ. value of Vout.

ELM91xxxxA CMOS PFM Step-up DC/DC converter and controller

<http://www.elm-tech.com>

ELM91333xA FET=ELM37400FA, L=33μH, Cin=Cout=100μF, D=MA735, Vss=0V, Top=25°C

Parameter	Symbol	Condition	Min.	Typ.	Max.	Unit
Output voltage	Vout	Iout=1mA, Vin=1.5V	3.218	3.300	3.382	V
Input voltage	Vin		0.9		6.0	V
Starting voltage	Vst	Iout=1mA			1.1	V
Holding voltage	Vhold	Iout=1mA			0.7	V
Current consumption 1	Iss1	Vout=Vout(T)×0.95, EXT: No-Load		15	35	μA
Current consumption 2	Iss2	Vout=Vout(T)+0.5V		2	5	μA
On-resistance of EXT "High"	Rexth	Vout=Vout(T)×0.95, Vext=Vout-0.4V		46	83	Ω
On-resistance of EXT "Low"	Rextl	Vout=Vout(T)×0.95, Vext=0.4V		33	55	Ω
Oscillating frequency	Fosc	Vout=Vout(T)×0.95	80	100	120	kHz
Duty ratio	Duty	Vout=Vout(T)×0.95	67	75	83	%

* Vout: Input voltage to out pin; Vout(T): Typ. value of Vout.

ELM91503xA FET=ELM37400FA, L=33μH, Cin=Cout=100μF, D=MA735, Vss=0V, Top=25°C

Parameter	Symbol	Condition	Min.	Typ.	Max.	Unit
Output voltage	Vout	Iout=1mA, Vin=3V	4.875	5.000	5.125	V
Input voltage	Vin		0.9		6.0	V
Starting voltage	Vst	Iout=1mA			1.1	V
Holding voltage	Vhold	Iout=1mA			0.7	V
Current consumption 1	ISS1	Vout=Vout(T)×0.95, EXT: No-Load		20	45	μA
Current consumption 2	ISS2	Vout=Vout(T)+0.5V		2	5	μA
On-resistance of EXT "High"	Rexth	Vout=Vout(T)×0.95, Vext=Vout-0.4V		33	59	Ω
On-resistance of EXT "Low"	Rextl	Vout=Vout(T)×0.95, Vext=0.4V		24	45	Ω
Oscillating frequency	Fosc	Vout=Vout(T)×0.95	80	100	120	kHz
Duty ratio	Duty	Vout=Vout(T)×0.95	67	75	83	%

* Vout: Input voltage to out pin; Vout(T): Typ. value of Vout.

■ Marking

- SOT-89, SOT-23 package : ELM91xx1xA
ELM91xx3xA

- SC-70-5 package : ELM91xxxCA

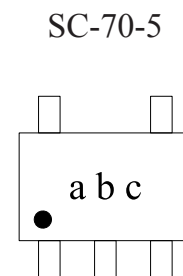
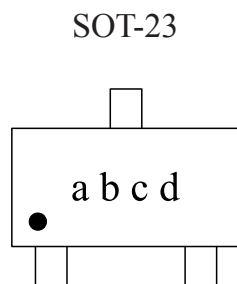
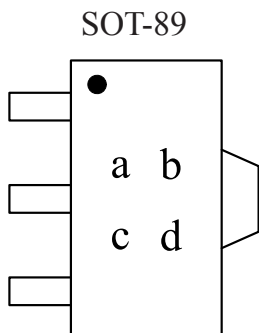

a to d : Assembly lot No. _____
A to Z (I, O, X excepted) and 0 to 9

a to c : Assembly lot No. _____
A to Z (I, O, X excepted) and 0 to 9

ELM91xxxxA CMOS PFM Step-up DC/DC converter and controller

<http://www.elm-tech.com>

External parts

To design DC/DC converters using ELM91xx1xA series, coil, diode, and capacitor are necessary. Except these external parts, switching transistor is also needed when using ELM91xx3xA. Please locate external parts to IC as close as possible, and lower the impedance of ground line. (Please refer to standard circuit)

1) Coil

When choosing choke coil, please select that whose core is not magnetically saturated, DC resistance is low, and which has sufficient margin for rated current.

The typical characteristics graphics of ELM91xx1xA series is done by following coil : SLF7045(TDK)

The typical characteristics graphics of ELM91xx3xA series is done by following coil : SLF10145(TDK)

2) Diode

When choosing diode, please select that whose forward voltage is small, switching speed is high and which has sufficient margin for rated current.

For ELM91 series, ELM recommends schottky diodes.

3) Capacitor

When choosing capacitor, please select that which is generally used for smoothing power supply circuit, with comparatively large capacity and whose rated voltage is at least three times larger than rated output voltage of used ELM91 series.

For ELM91 series, ELM recommends Aluminum electrolytic or Tantalum capacitor.

Under different conditions, such as different input voltage, load current, etc. larger output voltage ripple may happen and thus result in intermittent switching. To prevent output voltage ripple from becoming larger, please use capacitor with comparatively larger capacity or small ESR.

The output voltage of ELM91xx3xA may lower when the load current is large. To prevent this, please use output capacitor with comparatively large capacity or small ESR.

Following characteristics graphics are made with ELM91303xA, when $V_{in}=1.5V$. { $C_{in}=100\mu F(Ta)$, $L=33\mu H$ }

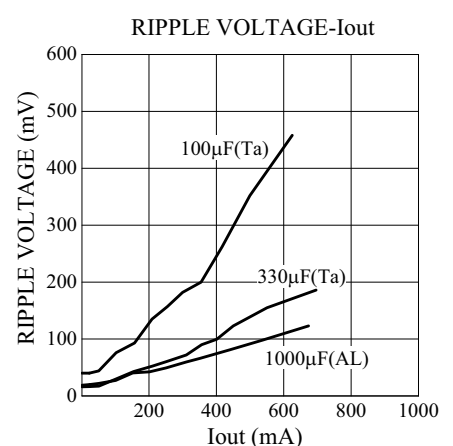
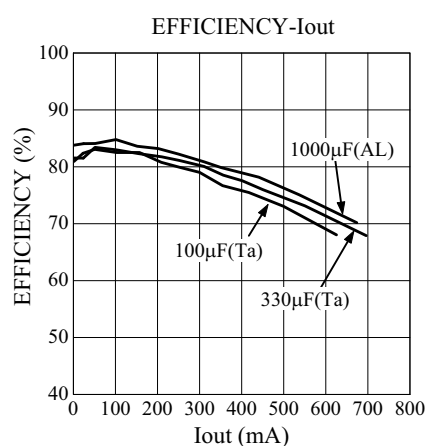
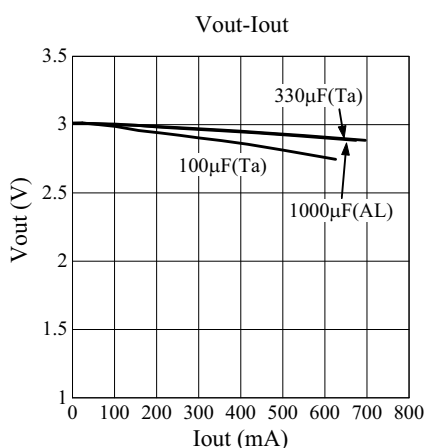

ELM91xxxxA CMOS PFM Step-up DC/DC converter and controller

<http://www.elm-tech.com>

■ Typical characteristics (ELM91xx1xA)

- ELM91181xA ($L=100\mu\text{H}$, $C_{in}=C_{out}=47\mu\text{F}$, $D=MA2Z748$, $T_{op}=25^\circ\text{C}$)

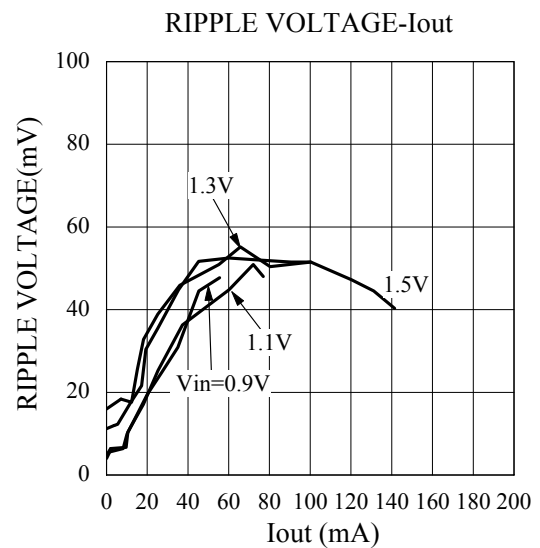
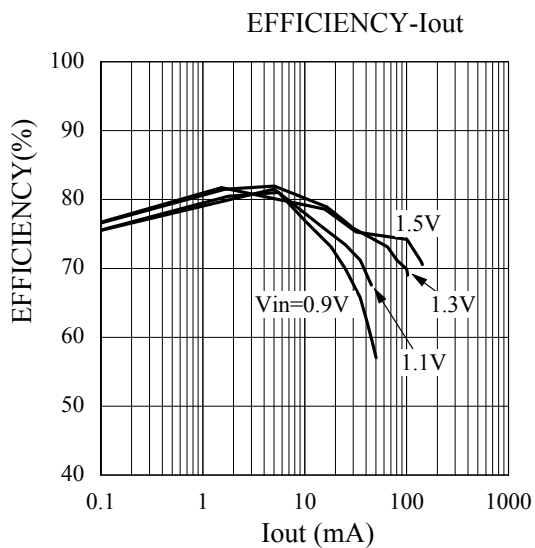
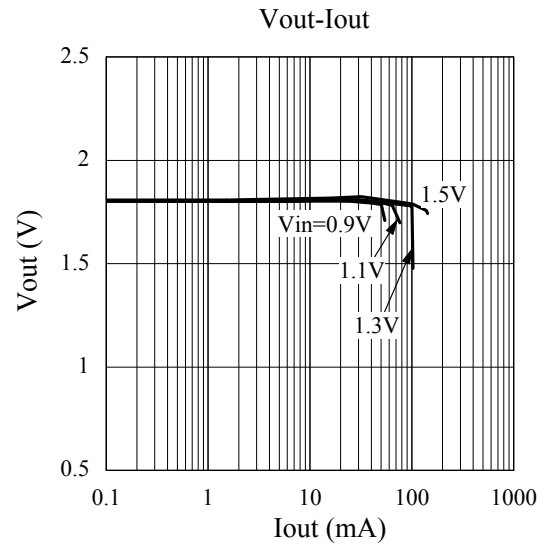
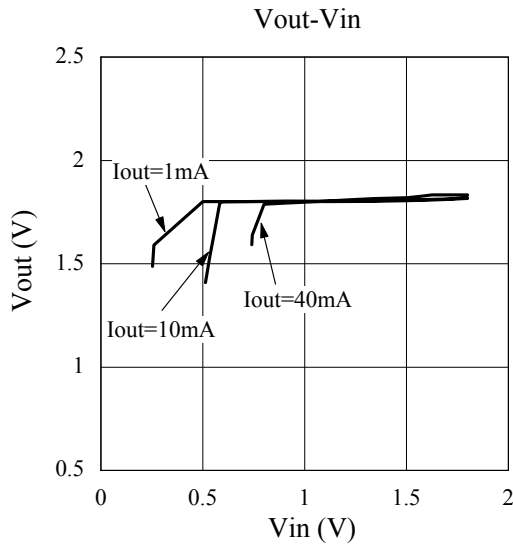

ELM91xxxxA CMOS PFM Step-up DC/DC converter and controller

<http://www.elm-tech.com>

Load Transient Response

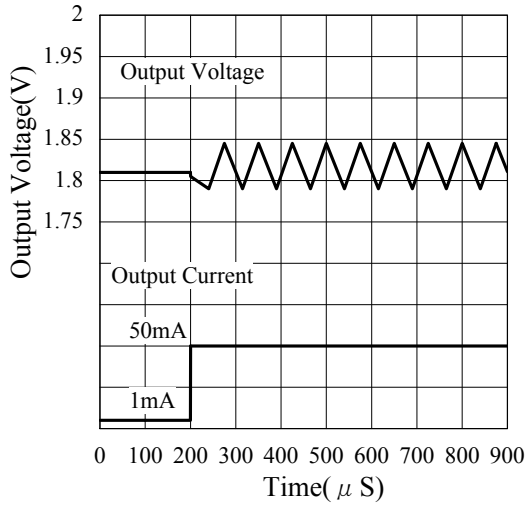

Load Transient Response

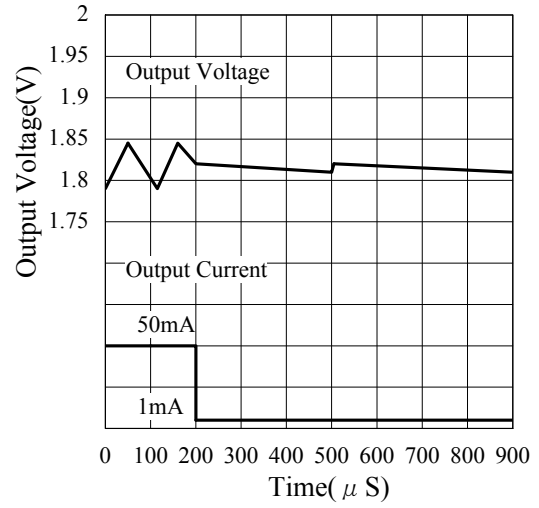

Vst-Iout

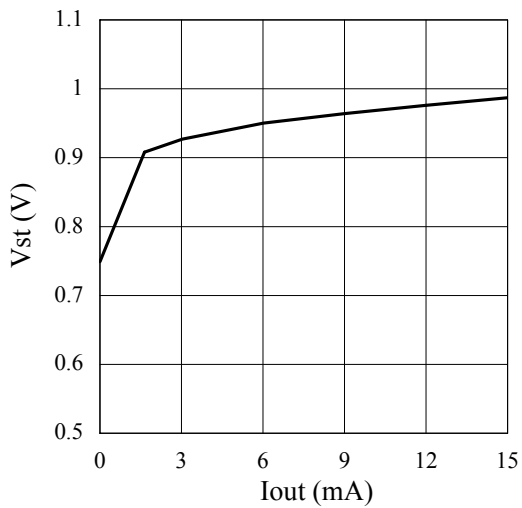

Vhold-Iout

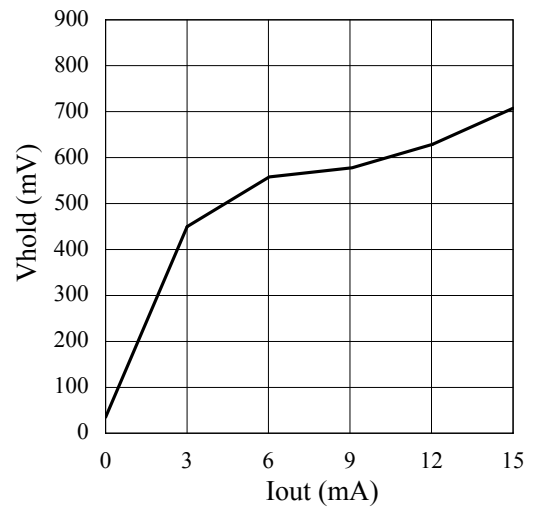

ELM91xxxxA CMOS PFM Step-up DC/DC converter and controller

<http://www.elm-tech.com>

- ELM91301xA(L=100 μ H, Cin=Cout=47 μ F, D=MA2Z748, Top=25 $^{\circ}$ C)

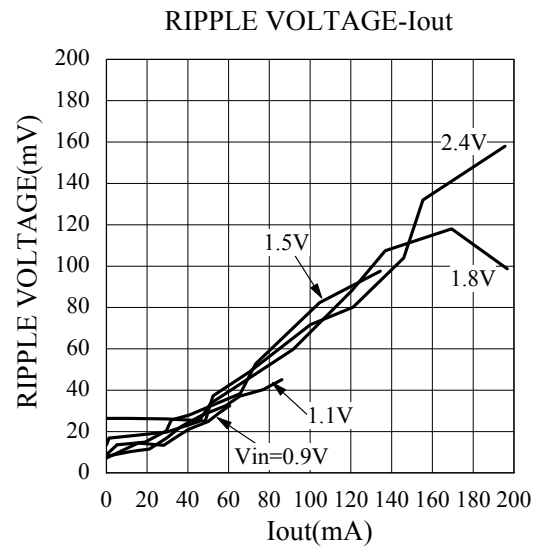
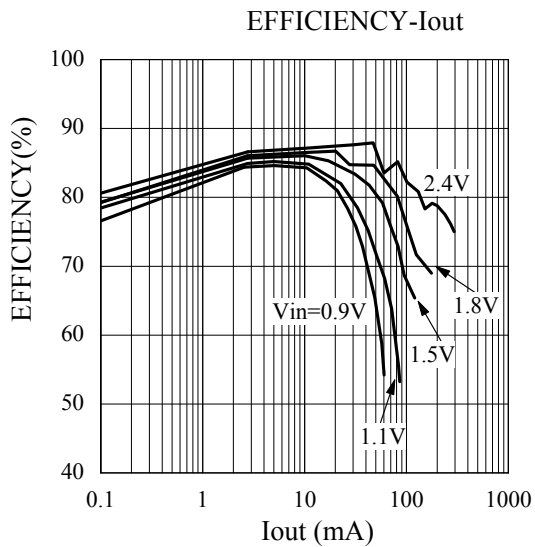
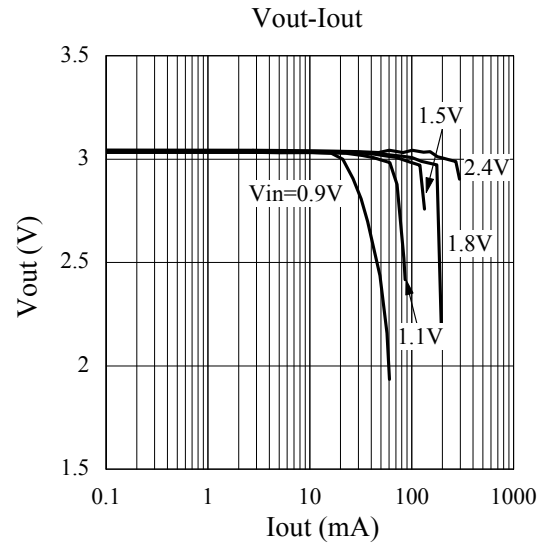
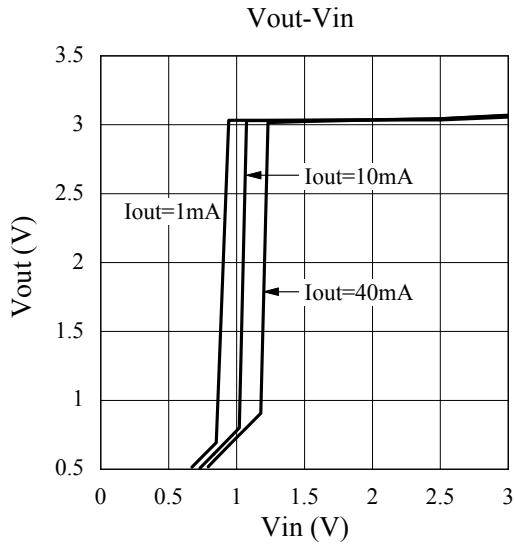

ELM91xxxxA CMOS PFM Step-up DC/DC converter and controller

<http://www.elm-tech.com>

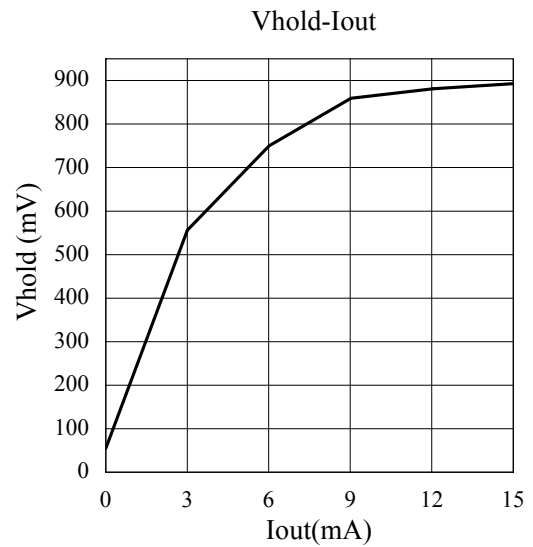
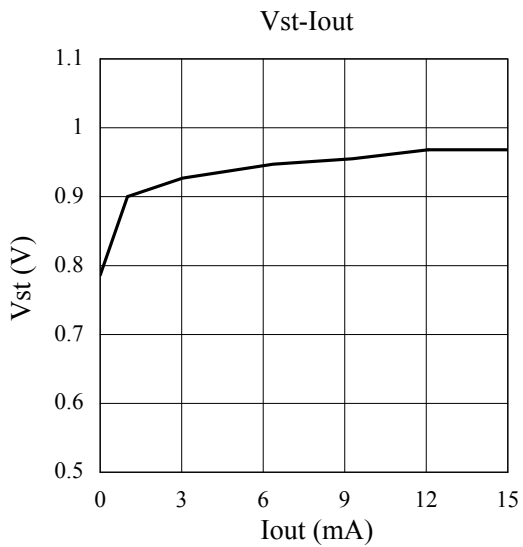
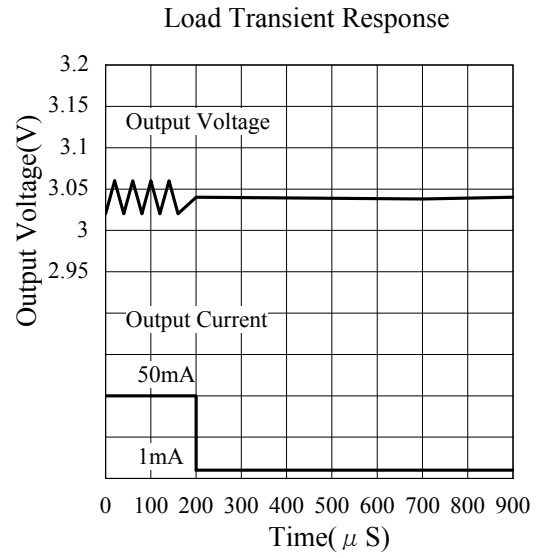
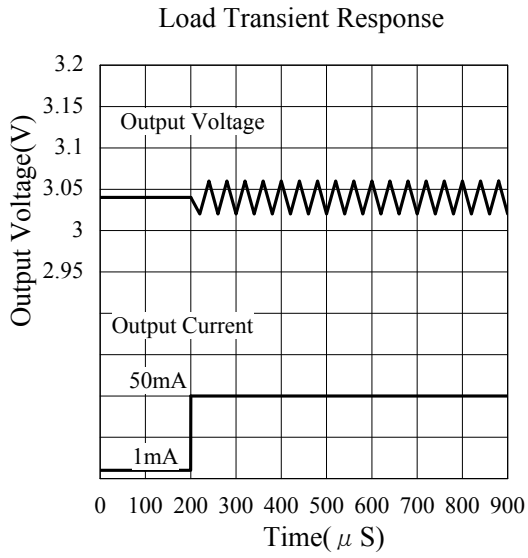

ELM91xxxxA CMOS PFM Step-up DC/DC converter and controller

<http://www.elm-tech.com>

- ELM91331xA ($L=100\mu\text{H}$, $C_{in}=C_{out}=47\mu\text{F}$, $D=MA2Z748$, $T_{op}=25^\circ\text{C}$)

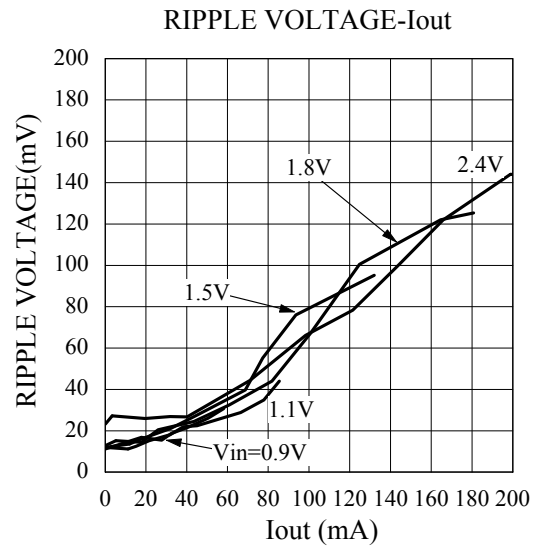
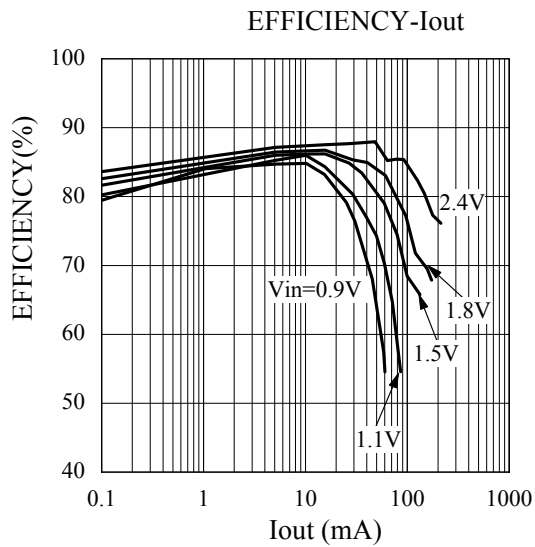
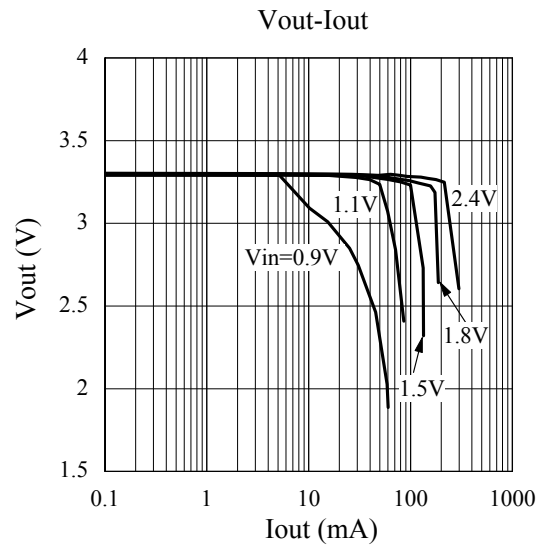
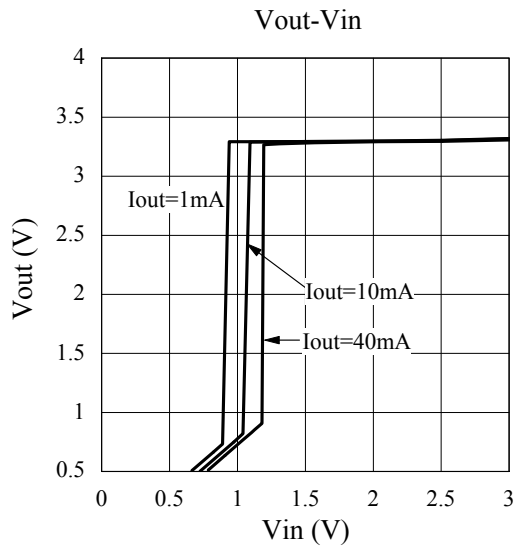

ELM91xxxxA CMOS PFM Step-up DC/DC converter and controller

<http://www.elm-tech.com>

Load Transient Response

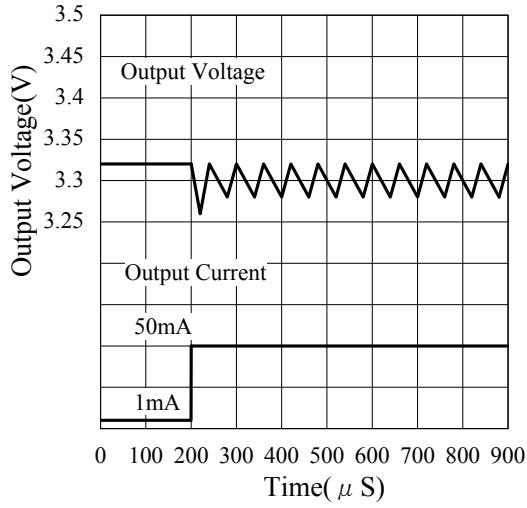

Load Transient Response

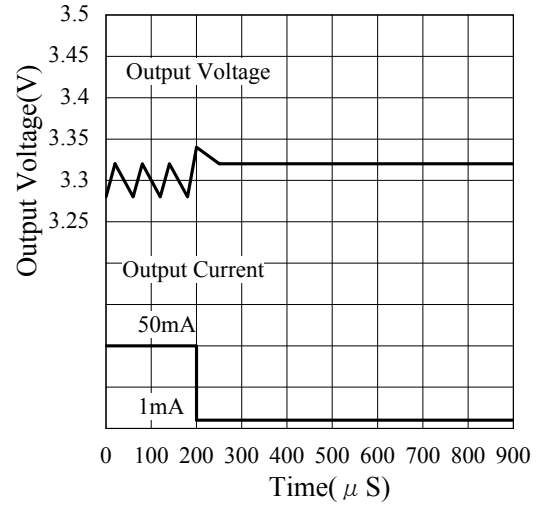

Vst-Iout

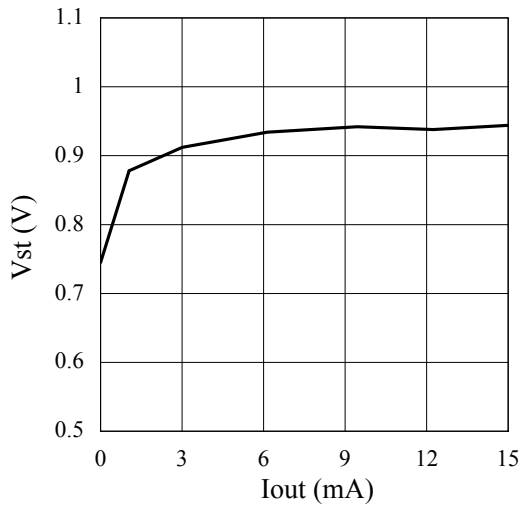

Vhold-Iout

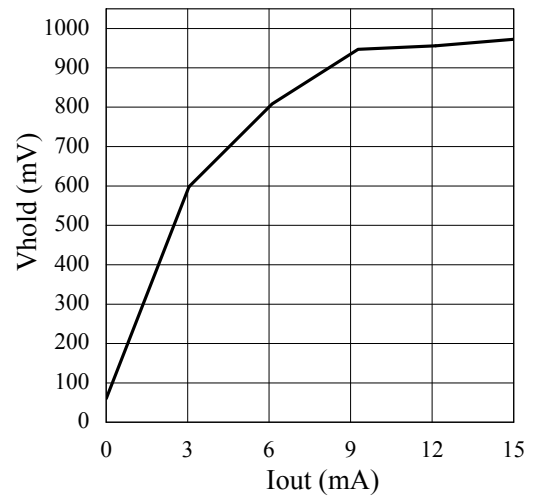

ELM91xxxxA CMOS PFM Step-up DC/DC converter and controller

<http://www.elm-tech.com>

- ELM91501xA ($L=100\mu\text{H}$, $C_{in}=C_{out}=47\mu\text{F}$, $D=MA2Z748$, $T_{op}=25^\circ\text{C}$)

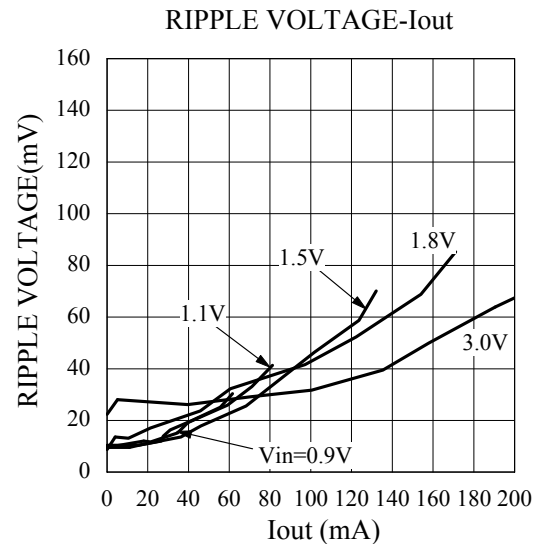
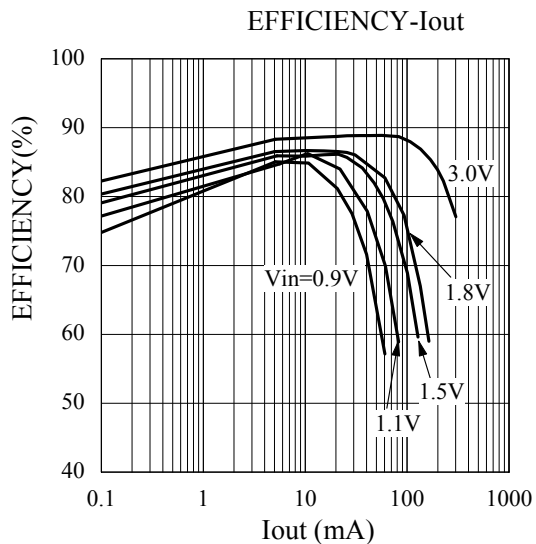
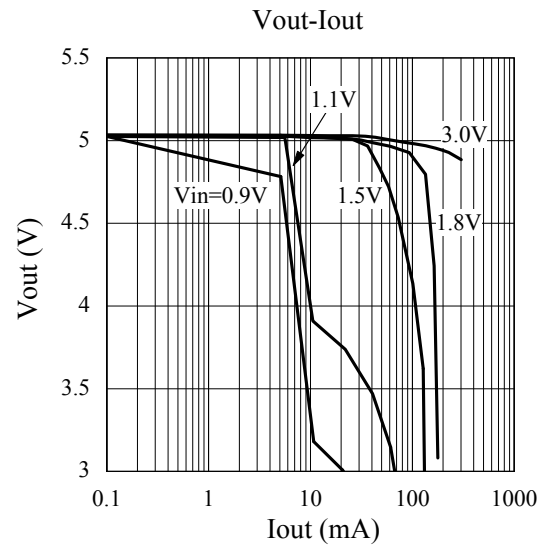
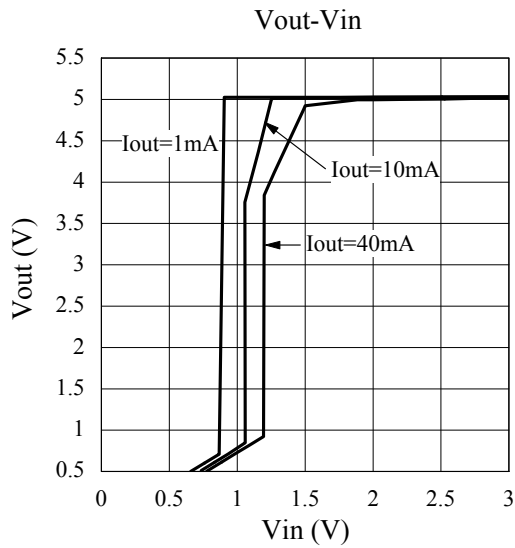

ELM91xxxxA CMOS PFM Step-up DC/DC converter and controller

<http://www.elm-tech.com>

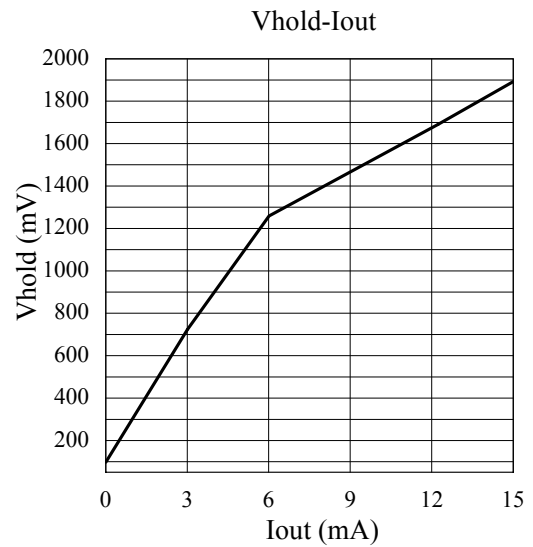
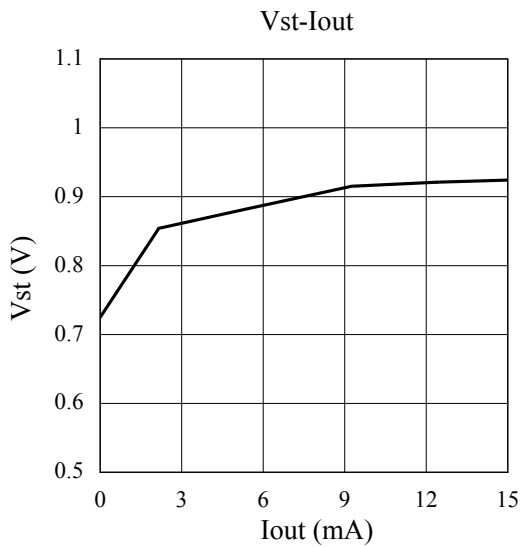
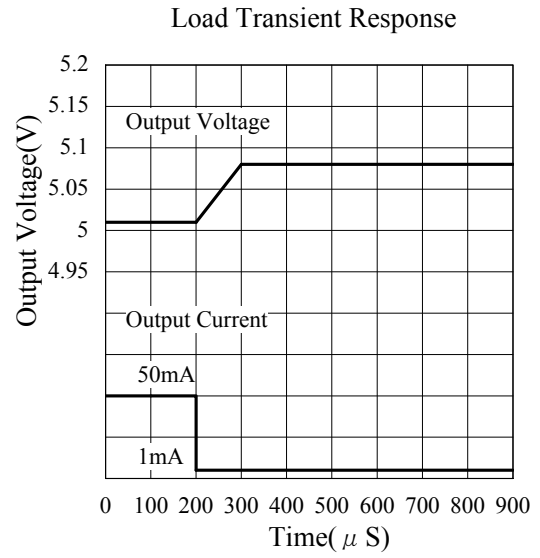
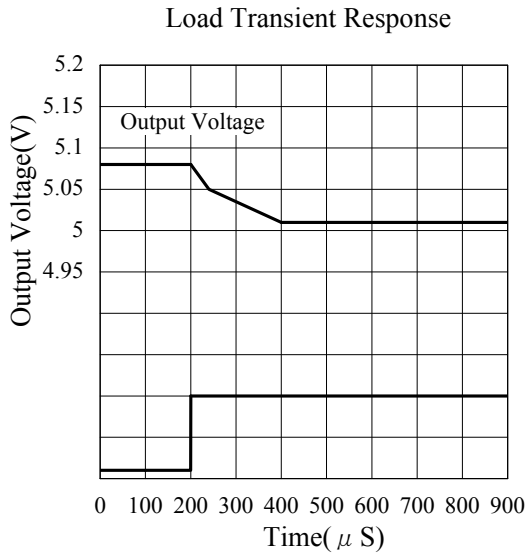

ELM91xxxxA CMOS PFM Step-up DC/DC converter and controller

<http://www.elm-tech.com>

■ Typical characteristics (ELM91xx3xA)

- ELM91183xA

(FET=ELM37400FA, L=33 μ H, Cin=Cout=100 μ F, D=MA735, Vss=0V, Top=25°C)

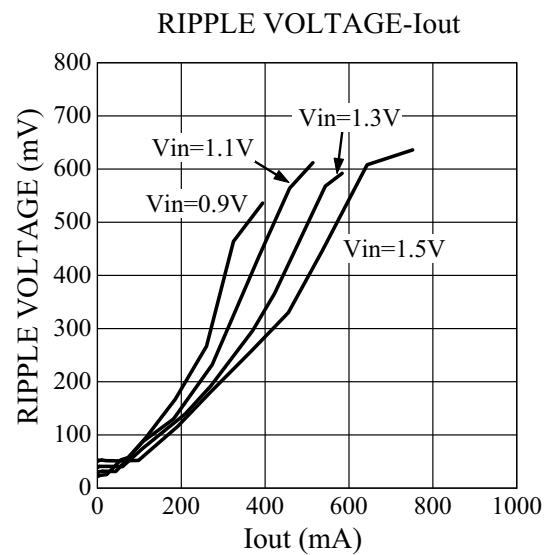
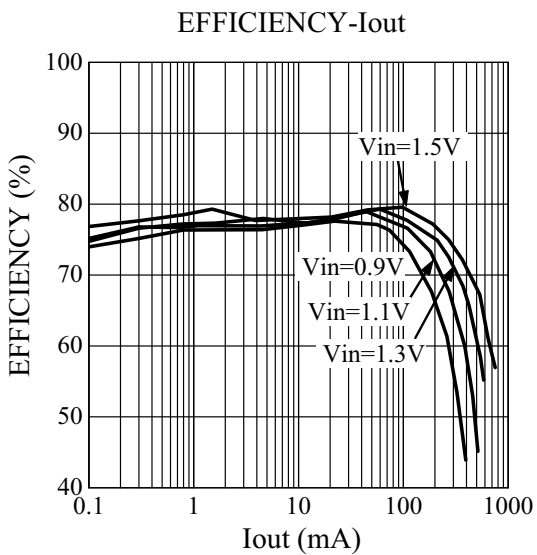
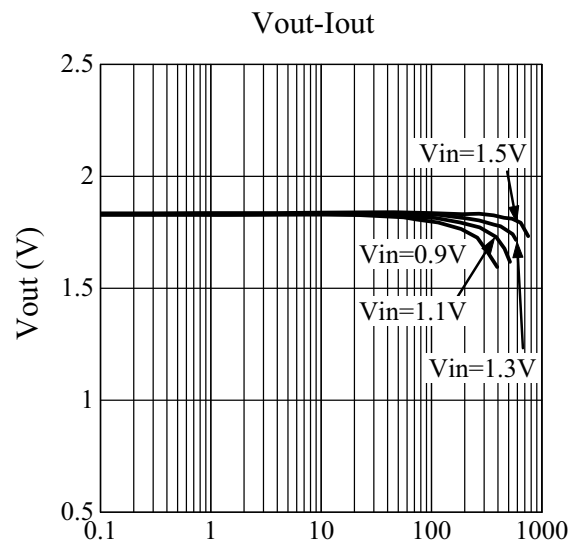
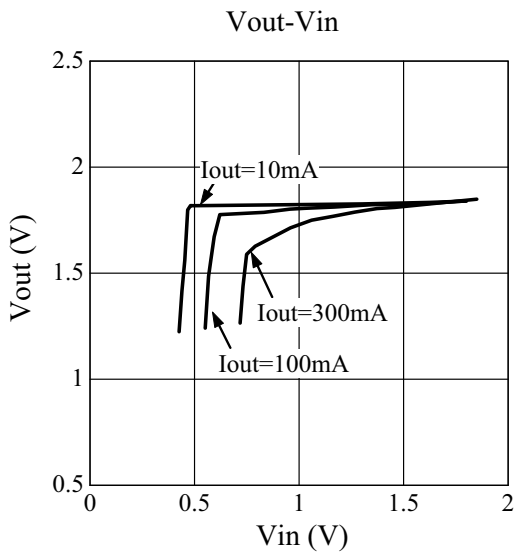

ELM91xxxxA CMOS PFM Step-up DC/DC converter and controller

<http://www.elm-tech.com>

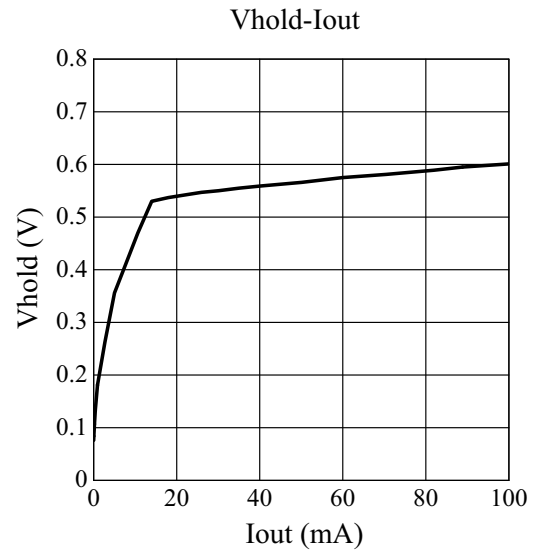
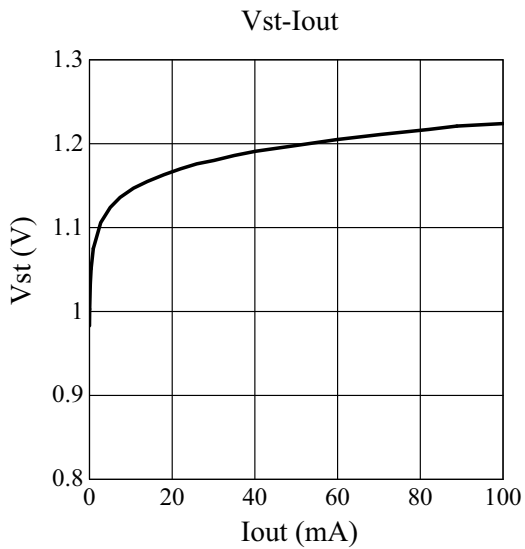
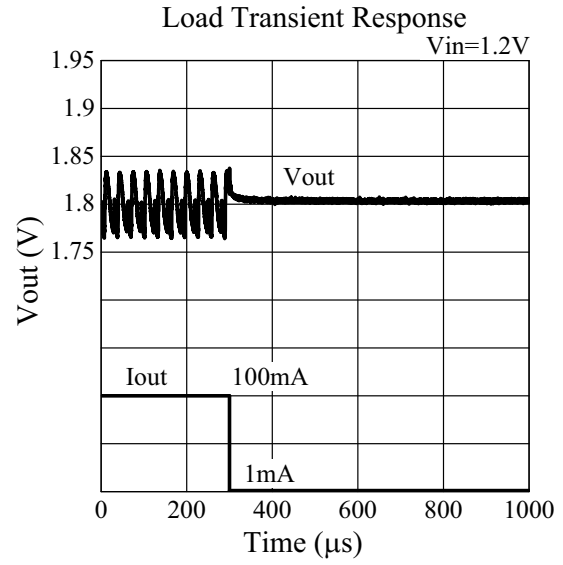
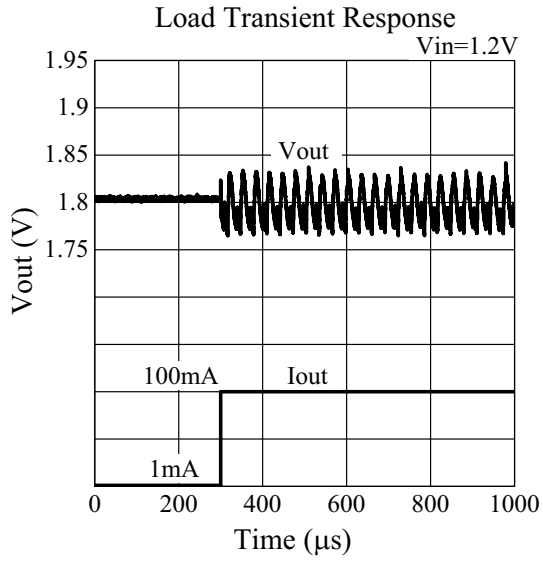

ELM91xxxxA CMOS PFM Step-up DC/DC converter and controller

<http://www.elm-tech.com>

- ELM91303xA
(FET=ELM37400FA, L=33 μ H, Cin=Cout=100 μ F, D=MA735, Vss=0V, Top=25°C)

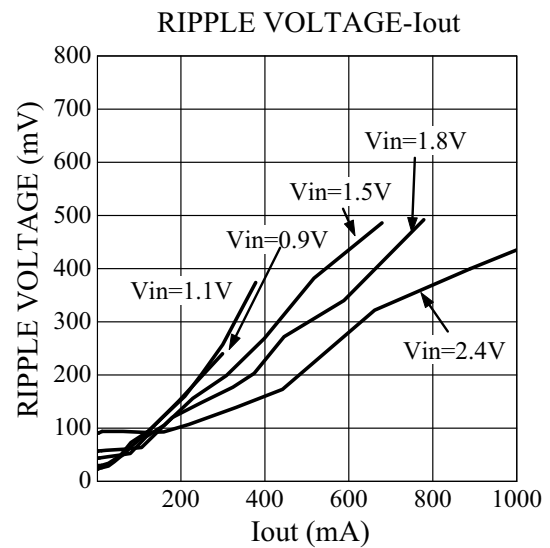
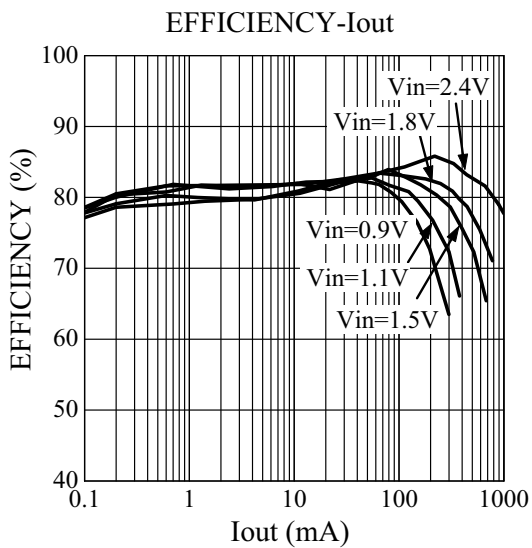
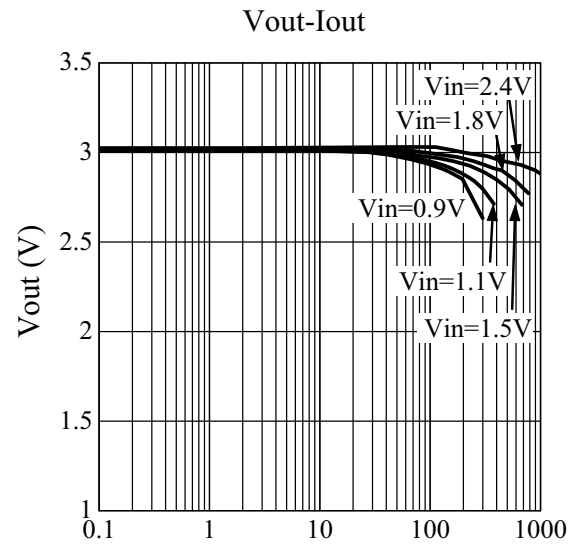
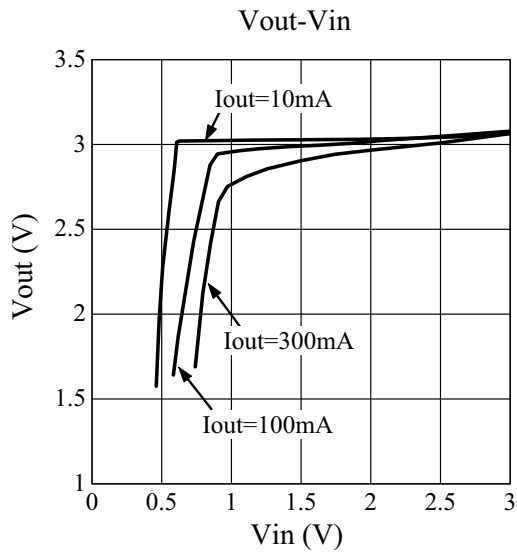

ELM91xxxxA CMOS PFM Step-up DC/DC converter and controller

<http://www.elm-tech.com>

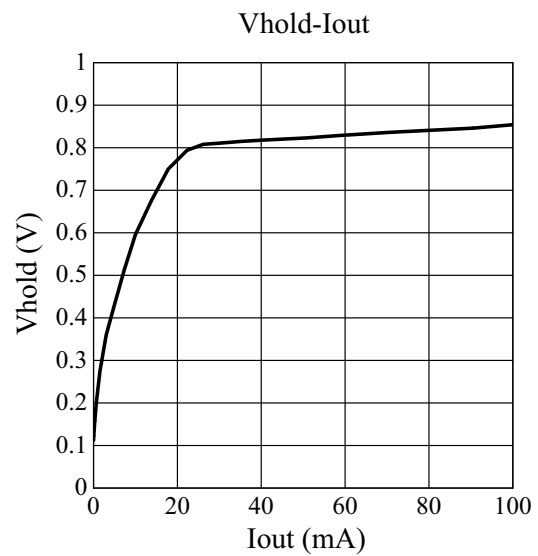
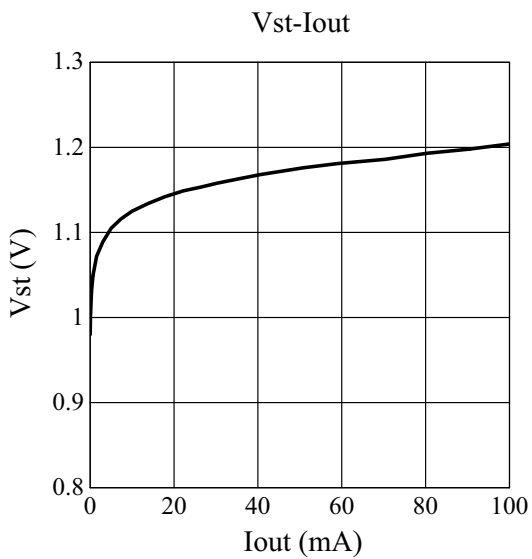
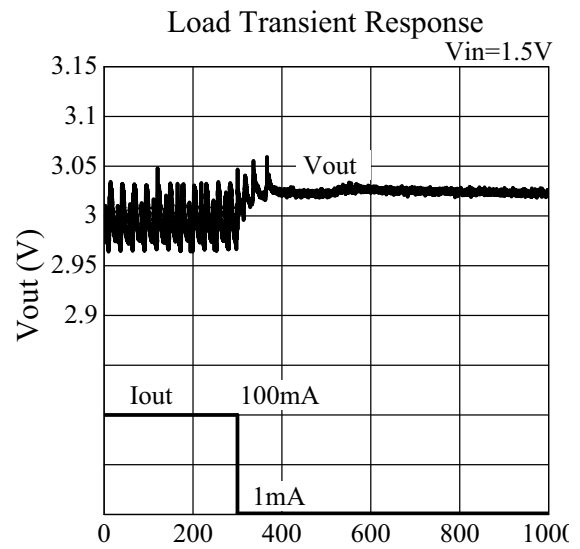
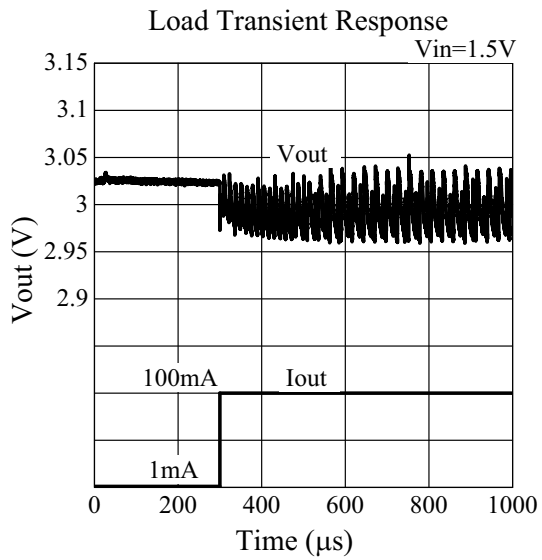

ELM91xxxxA CMOS PFM Step-up DC/DC converter and controller

<http://www.elm-tech.com>

- ELM91333xA
(FET=ELM37400FA, L=33 μ H, Cin=Cout=100 μ F, D=MA735, Vss=0V, Top=25°C)

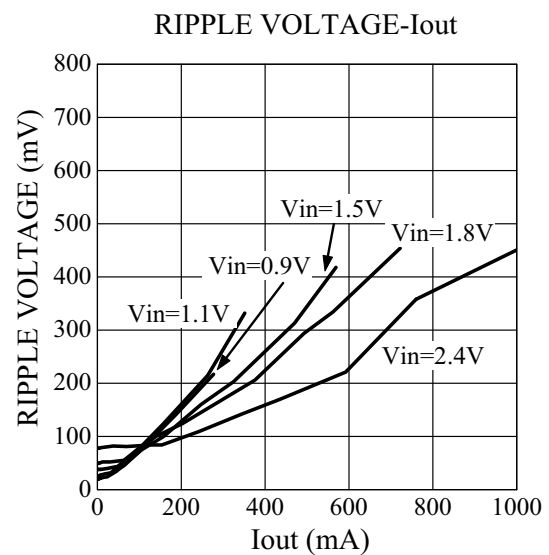
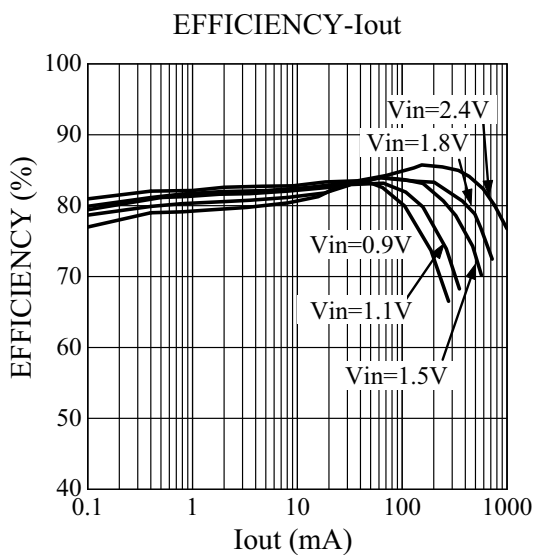
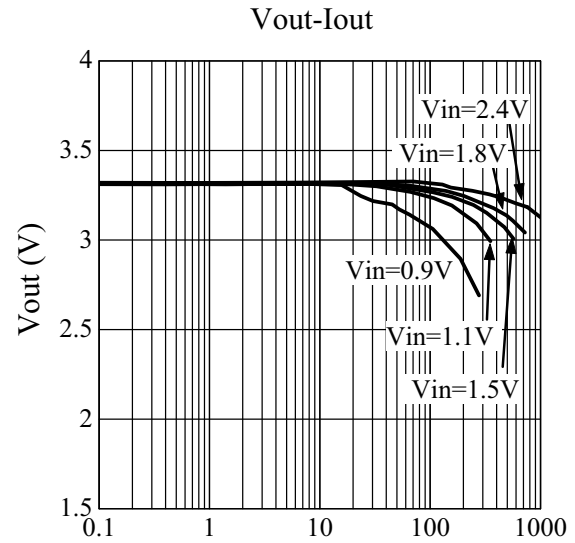
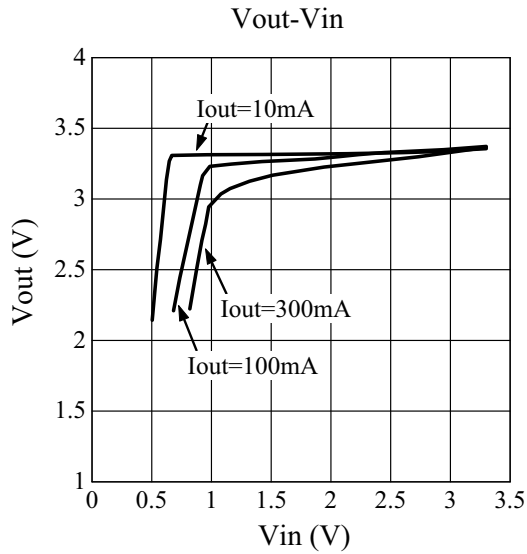

ELM91xxxxA CMOS PFM Step-up DC/DC converter and controller

<http://www.elm-tech.com>

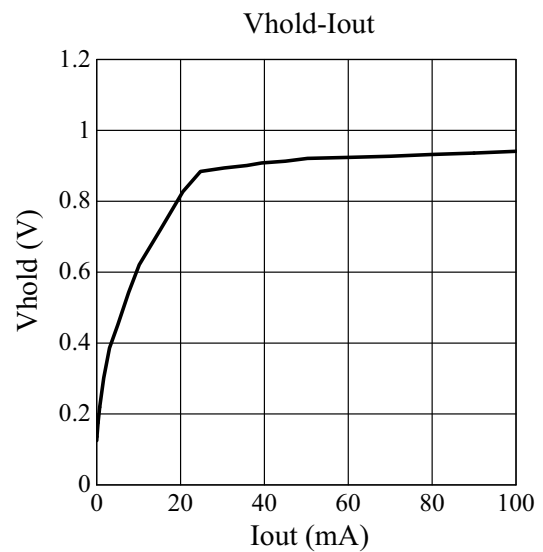
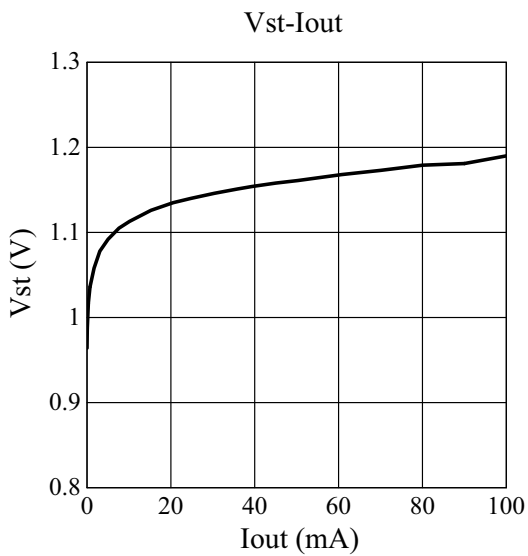
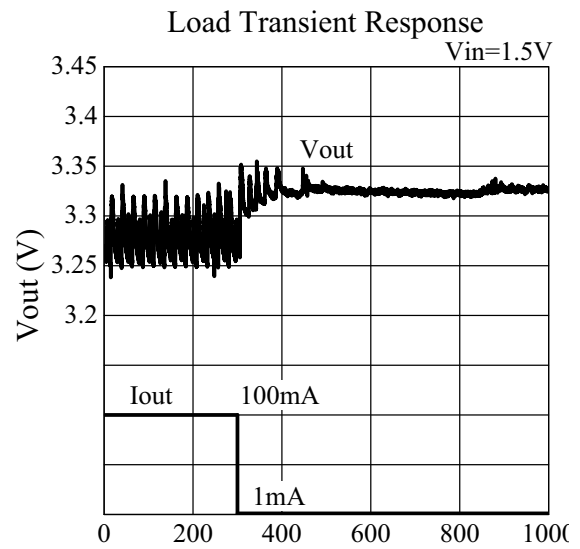
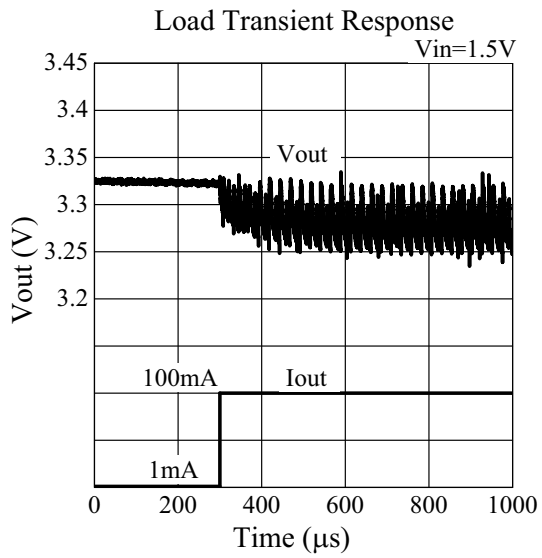

ELM91xxxxA CMOS PFM Step-up DC/DC converter and controller

<http://www.elm-tech.com>

- ELM91503xA

(FET=ELM37400FA, L=33 μ H, Cin=Cout=100 μ F, D=MA735, Vss=0V, Top=25°C)

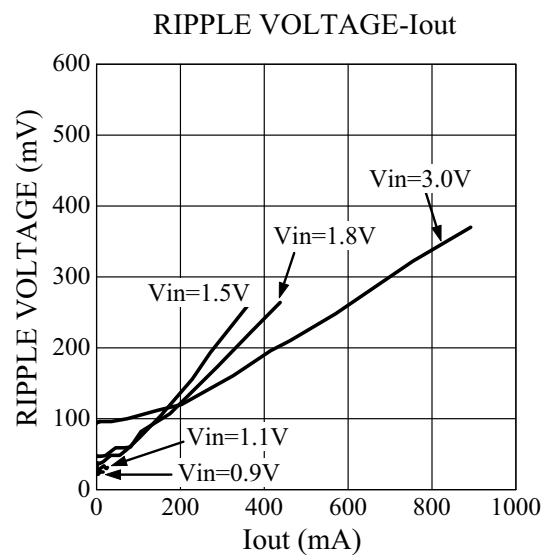
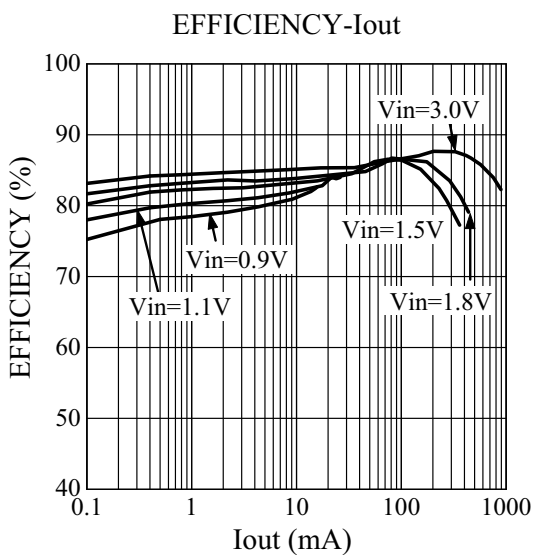
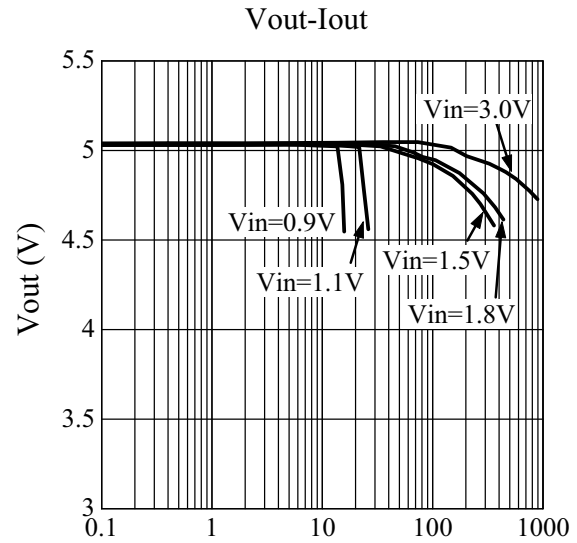
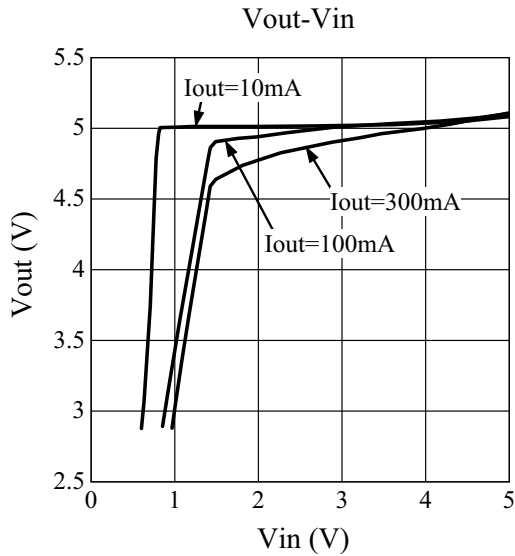

ELM91xxxxA CMOS PFM Step-up DC/DC converter and controller

<http://www.elm-tech.com>

