

CRYSTAL CONTROLLED OSCILLATORS

SURFACE MOUNT 3.3V PECL CLOCK



EML5443

ABSOLUTE MAXIMUM RATINGS

TABLE 1.0

PARAMETER	UNITS	MINIMUM	NOMINAL	MAXIMUM	UNITS	NOTE
Storage Temperature		-55	-	125	°C	
Supply Voltage	(Vcc)	-0.5	-	7.0	Vdc	

OPERATING SPECIFICATIONS

TABLE 2.0

PARAMETER		MINIMUM	NOMINAL	MAXIMUM	UNITS	NOTE
Center Frequency	(Fo)	19.44	-	164	MHz	
Total Frequency Tolerance		-20	-	20	ppm	1
Operating Temperature Range		0	-	70	°C	
Supply Voltage	(Vcc)	3.135	3.3	3.465	Vdc	
Supply Current	(Icc)	-	-	60	mA	
Jitter (BW=10Hz to 20MHz)		-	-	5	ps rms	
Jitter (BW=12kHz to 20MHz)		-	-	1	ps rms	
SSB Phase Noise at 10Hz offset		-	-60	-	dBc/Hz	
SSB Phase Noise at 100Hz offset		-	-90	-	dBc/Hz	
SSB Phase Noise at 1KHz offset		-	-100	-	dBc/Hz	
SSB Phase Noise at 10KHz offset		-	-125	-	dBc/Hz	
SSB Phase Noise at 10KHz offset		-	-135	-	dBc/Hz	

PECL OUTPUT CHARACTERISTICS

TABLE 3.0

PARAMETER		MINIMUM	NOMINAL	MAXIMUM	UNITS	NOTE
LOAD		-	-	50	Ohms	2
Voltage (High)	(Voh)	2.275	-	-	Vdc	
(Low)	(Vol)	-	-	1.68	Vdc	
Duty Cycle		45	50	55	%	3
Rise / Fall Time 20% to 80%		-	-	1	nS	

PACKAGE CHARACTERISTICS

TABLE 4.0

Package	Hermetically sealed, ceramic package with gold plated J leads.
---------	--

Notes

- 1) Includes calibration, stability vs. temperature, supply and load variations, shock, vibration and aging (10 years).
- 2) Output must be terminated into 50 ohms to Vcc - 2V or Thevenin equivalent.
- 3) Duty Cycle measured at 1.977V

DESCRIPTION

The Connor-Winfield EML5443 is a fixed frequency surface mount Crystal Controlled Oscillator (XO) designed for applications requiring low jitter and tight Frequency stability. Operating at 3.3V supply voltage, the EML5443 provides LVPECL compatible outputs.

FEATURES

3.3V OPERATION

LVPECL DIFFERENTIAL OUTPUTS

LOW JITTER <1pS RMS

OVERALL FREQUENCY TOLERANCE:
±20ppm

TEMPERATURE RANGE:
0 to 70°C

SURFACE MOUNT PACKAGE

TAPE AND REEL PACKAGING

ORDERING INFORMATION

EML5443 - 155.52MHz

PECL
SERIES

CENTER
FREQUENCY

Specifications subject to change without notice.

CRYSTAL CONTROLLED OSCILLATORS

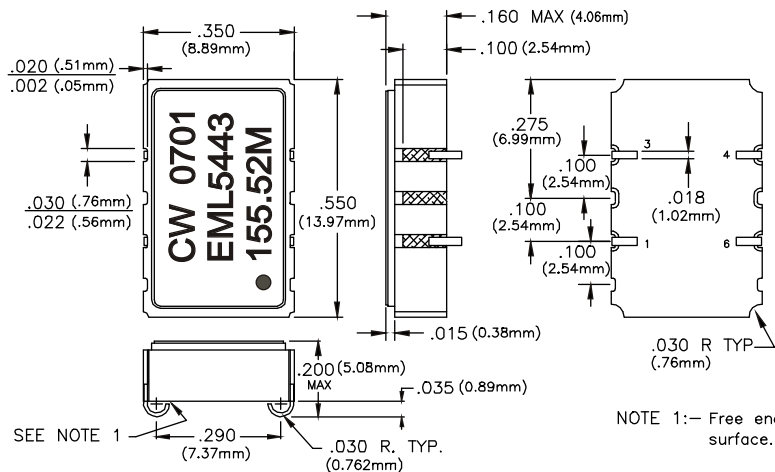

Pin	Connection
1	Q Output (comp)
2	N/C
3	Ground
4	Q Output
5	N/C
6	Vcc

NOTE 1:- Free end of J lead not attached to bottom surface.

OUTPUT WAVEFORM

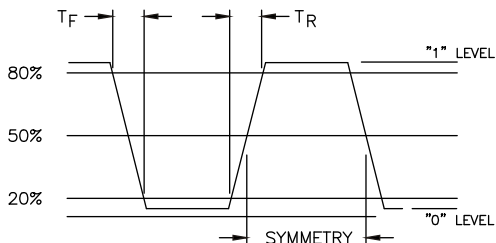

SUGGESTED PAD LAYOUT

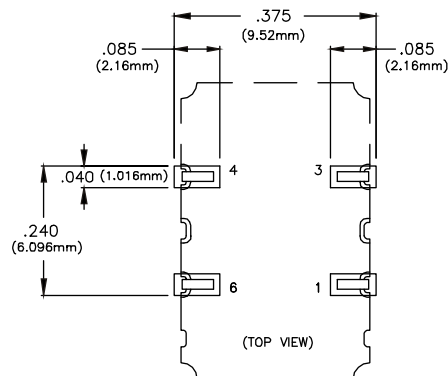

TEST CIRCUIT

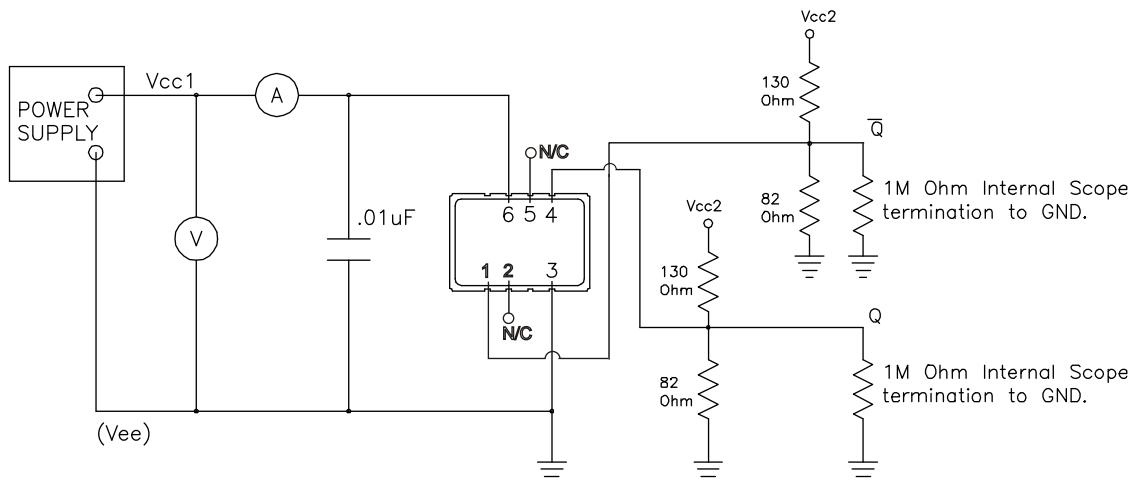

Specifications subject to change without notice.