

Features

- Attenuation: 0.5 dB Steps to 15.5 dB
- Minimal Phase Variation over Attenuation Range
- Low DC Power Consumption
- Small Footprint, PQFN Package
- Integral TTL Driver
- 50 ohm Impedance
- Test Boards are Available
- RoHS* Compliant

Description

M/A-COM's MAAD-009170-000100 is a GaAs pHEMT 5-bit digital attenuator with integral TTL driver in an PQFN plastic surface mount package. Step size is 0.5 dB providing a 15.5 dB total attenuation range. This design has been optimized to minimize phase variation over the attenuation range. MAAD-009170-000100 is ideally suited for use where accuracy, fast switching, very low power consumption and low intermodulation products are required. Typical applications include dynamic range setting in precision receiver circuits and other gain/leveling control circuits.

Ordering Information

Part Number	Package
MAAD-009170-000100	Bulk Packaging
MAAD-009170-0001TR	1000 piece reel
MAAD-009170-0001TB	Sample Test Board

Note: Reference Application Note M513 for reel size information.

* Restrictions on Hazardous Substances, European Union Directive 2002/95/EC.

Functional Schematic

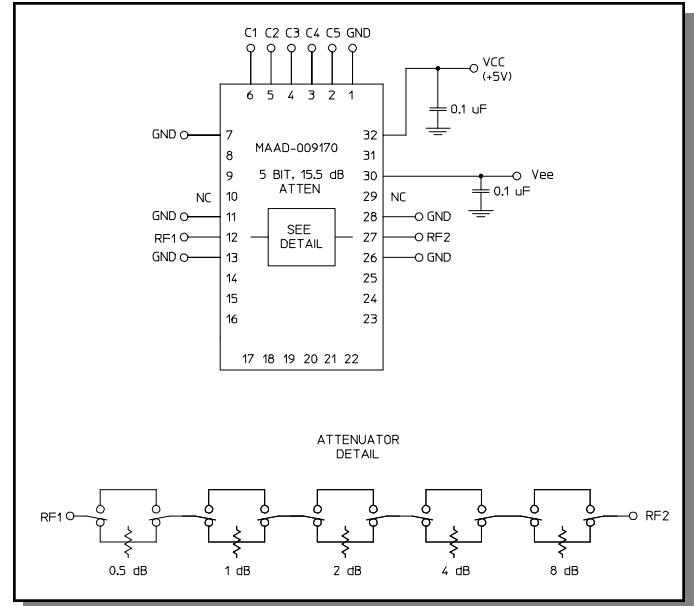

Pin Configuration¹

Pin No.	Function	Pin No.	Function
1	GND	17	NC
2	C5	18	NC
3	C4	19	NC
4	C3	20	NC
5	C2	21	NC
6	C1	22	NC
7	GND	23	NC
8	NC	24	NC
9	NC	25	NC
10	NC ²	26	GND
11	GND	27	RF2
12	RF1	28	GND
13	GND	29	NC ²
14	NC	30	Vee
15	NC	31	NC
16	NC	32	+Vcc

1. The exposed pad centered on the package bottom must be connected to RF and DC ground. (For PQFN Packages)
2. Pins 10 & 29 must be isolated

Electrical Specifications: $T_A = 25^\circ\text{C}$, $Z_0 = 50\Omega$, $V_{CC} = +5.0\text{V}$, $V_{EE} = -5.0\text{V}$

Parameter	Test Conditions	Frequency	Units	Min	Typ	Max
Operating Power ³	—	—	dBm	—	—	+20
Reference Insertion Loss	—	DC - 2.0 GHz 2.0 - 4.0 GHz	dB dB	— —	— —	4.7 5.2
Attenuation Accuracy ⁴ Relative to Reference Loss State	Any Single Bit Any Combination of Bits	DC - 4.0 GHz DC - 4.0 GHz	±(0.25 +2% of atten setting in dB) ±(0.25 +2% of atten setting in dB)			
Phase Accuracy Relative to Reference Loss State	Any Single Bit	DC - 2.0 GHz	deg	—	—	±2°
	Any Single Bit	2.0 - 4.0 GHz	deg	—	—	±3°
	Any Combination of Bits	DC - 2.0 GHz	deg	—	—	±4°
	Any Combination of Bits	2.0 - 4.0 GHz	deg	—	—	±7°
VSWR	Full Range	DC - 4.0 GHz	Ratio	—	—	1.9:1
Switching Speed	1.3 V Cntl to 90% RF	—	ns	—	47	—
	1.3 V Cntl to 10% RF	—	ns	—	24	—
	10% RF to 90% RF	—	ns	—	23	—
	90% RF to 10% RF	—	ns	—	13	—
1 dB Compression ⁵	Reference State	0.05 GHz	dBm	—	>+26	—
	Reference State	0.5 - 4.0 GHz	dBm	—	>+26	—
Input IP3	Two-tone inputs up to +5 dBm	0.05-4.0 GHz	dBm	—	+43 +40	—
Input IP2	Two-tone inputs up to +5 dBm	0.05-4.0 GHz	dBm	—	+50 +72	—
V _{CC}	—	—	V	4.5	5.0	5.5
V _{EE}	—	—	V	-8.0	-5.0	-4.5
V _{IL}	LOW-level input voltage	—	V	0.0	0.0	0.8
V _{IH}	HIGH-level input voltage	—	V	2.0	5.0	5.0
I _{in} (Input Leakage Current)	V _{in} = V _{CC} or GND	—	uA	-1	—	1
I _{CC} (Quiescent Supply Current)	V _{cntrl} = V _{CC} or GND	—	uA	—	250	400
ΔI _{CC} (Additional Supply Current Per TTL Input Pin)	V _{CC} = Max V _{cntrl} = V _{CC} - 2.1 V	—	mA	—	—	1.5
I _{EE}	V _{EE} min to max V _{in} = V _{IL} or V _{IH}	—	mA	-1.0	-0.2	—
Thermal Resistance θ _{JC}	—	—	°C/W	—	35	—

- Maximum operating power is specified with the input applied to RF1. If the input is applied to RF2, then maximum operating power is +16 dBm.
- This attenuator is guaranteed monotonic.
- 1 dB Compression was measured up to +26 dBm, which is the absolute maximum rating for this device.

Absolute Maximum Ratings ^{6,7}

Parameter	Absolute Maximum
Max. Input Power ⁸ DC - 4.0 GHz	+26 dBm
V _{CC}	-0.5V ≤ V _{CC} ≤ +7.0V
V _{EE}	-8.5V ≤ V _{EE} ≤ +0.5V
V _{CC} - V _{EE}	-0.5V ≤ V _{CC} - V _{EE} ≤ 14.5V
V _{in} ⁹	-0.5V ≤ V _{in} ≤ V _{CC} + 0.5V
Operating Temperature	-40°C to +85°C
Storage Temperature	-65°C to +125°C

- Exceeding any one or combination of these limits may cause permanent damage to this device.
- M/A-COM does not recommend sustained operation near these survivability limits.
- The maximum operating power is specified with the input applied to RF1. If the input is applied to RF2, then maximum operating power is +22 dBm
- Standard CMOS TTL interface, latch-up will occur if logic signal is applied prior to power supply.

Handling Procedures

Please observe the following precautions to avoid damage:

Static Sensitivity

Gallium Arsenide Integrated Circuits are sensitive to electrostatic discharge (ESD) and can be damaged by static electricity. Proper ESD control techniques should be used when handling these devices.

Moisture Sensitivity

The MSL rating for this part is defined as Level 2 per IPC/JEDEC J-STD-020. Parts shall be stored and/or baked as required for MSL Level 2 parts.

Recommended PCB Configuration ¹⁰

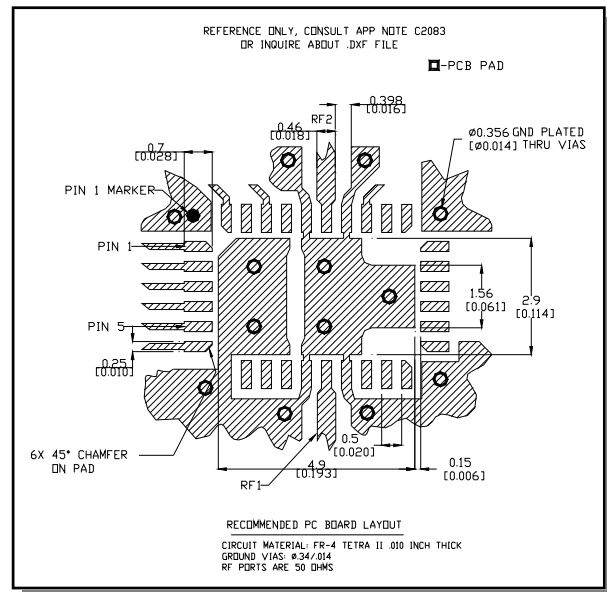

- Application Note S2083 is available on line at www.macom.com

Truth Table (Digital Attenuator)

C5	C4	C3	C2	C1	Attenuation
0	0	0	0	0	Loss, Reference
0	0	0	0	1	0.5 dB
0	0	0	1	0	1.0 dB
0	0	1	0	0	2.0 dB
0	1	0	0	0	4.0 dB
1	0	0	0	0	8.0 dB
1	1	1	1	1	15.5 dB

0 = TTL Low; 1 = TTL High

Typical Performance Curves

Reference Loss vs. Frequency

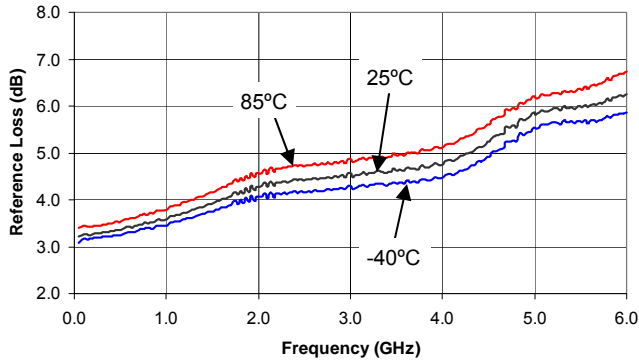

Attenuation - 0.5 dB Bit vs. Frequency

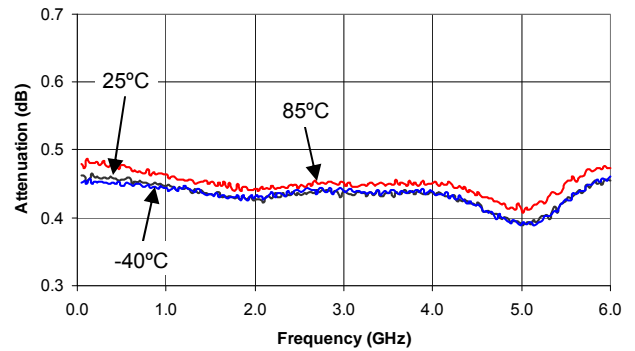

Attenuation - 1 dB Bit vs. Frequency

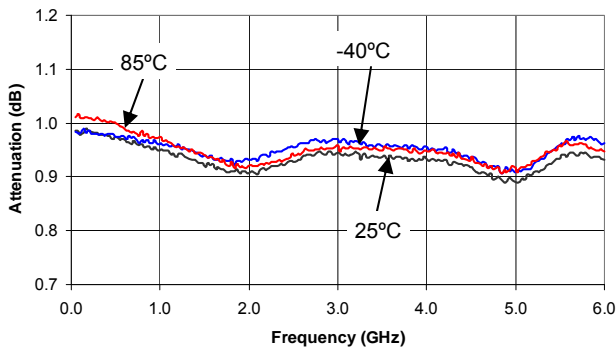

Attenuation - 2 dB Bit vs. Frequency

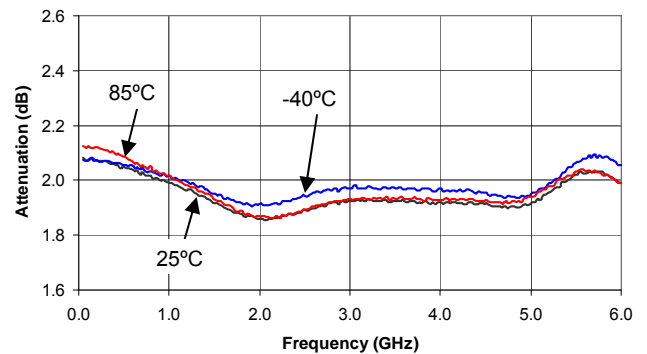

Attenuation - 4 dB Bit vs. Frequency

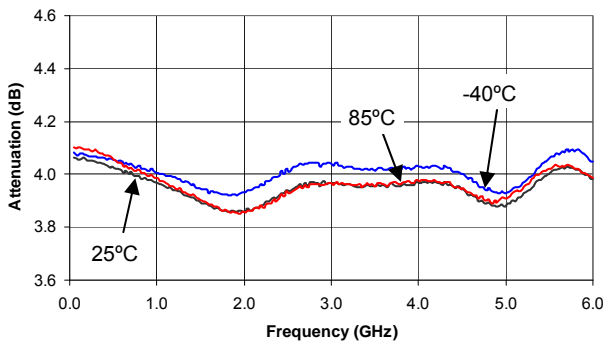

Attenuation - 8 dB Bit vs. Frequency

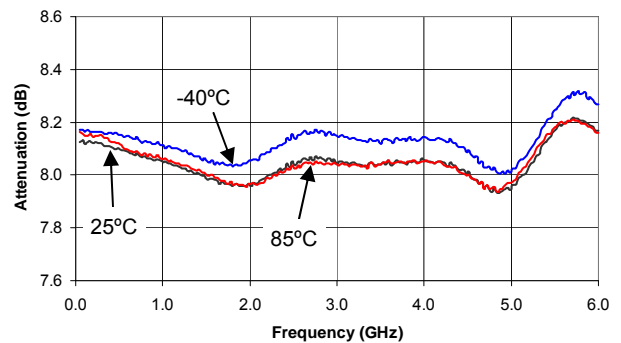

Typical Performance Curves

Attenuation - 15.5 dB Attenuation vs. Frequency

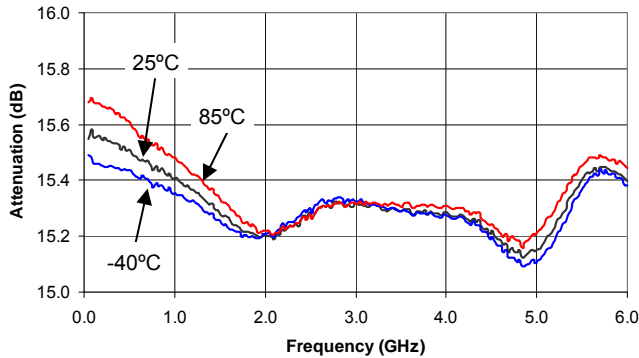

Phase - 0.5 dB Bit vs. Frequency
Relative to Reference Loss State

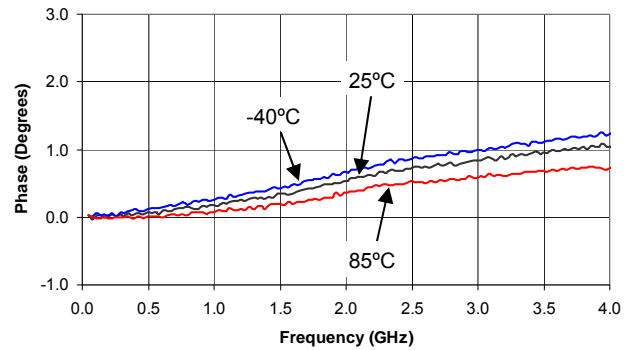

Phase - 1 dB Bit vs. Frequency
Relative to Reference Loss State

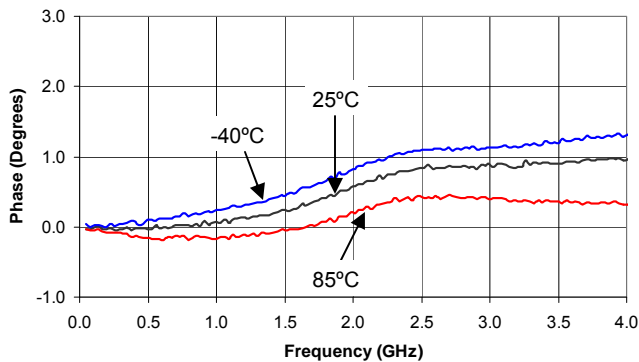

Phase - 2 dB Bit vs. Frequency
Relative to Reference Loss State

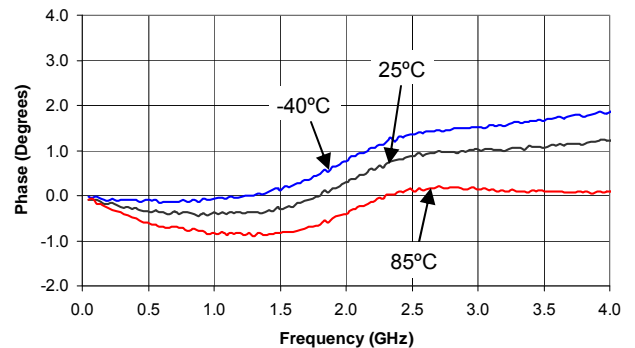

Phase - 4 dB Bit vs. Frequency
Relative to Reference Loss State

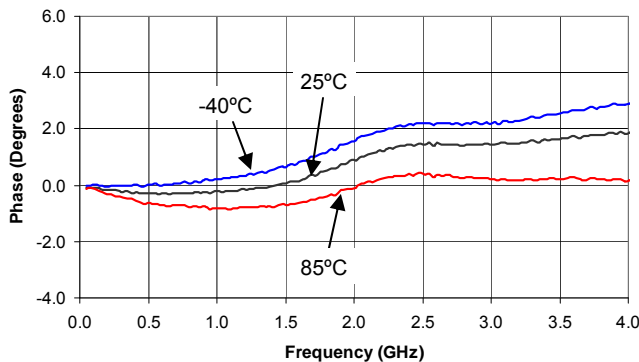

Phase - 8 dB Bit vs. Frequency
Relative to Reference Loss State

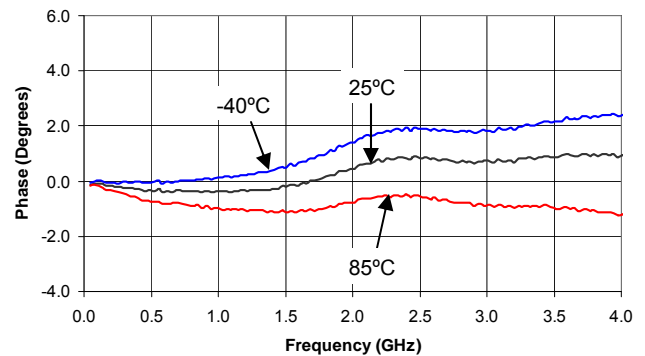

Typical Performance Curves

Phase - 15.5 dB Attenuation vs. Frequency Relative to Reference Loss State

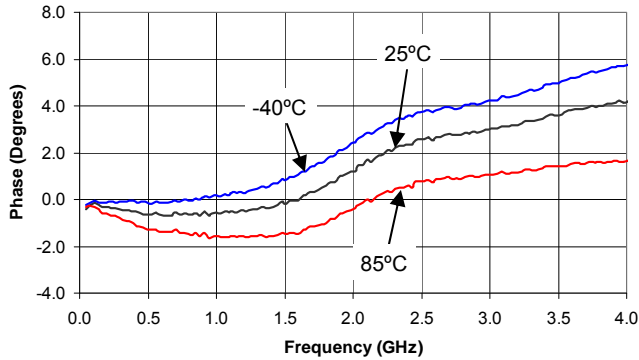

VSWR - Reference State vs. Frequency

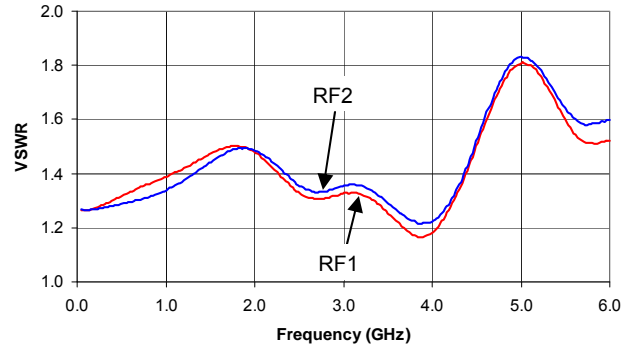

VSWR - 0.5 dB Bit vs. Frequency

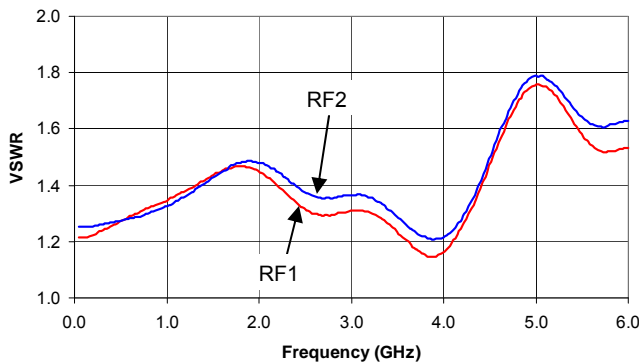

VSWR - 1 dB Bit vs. Frequency

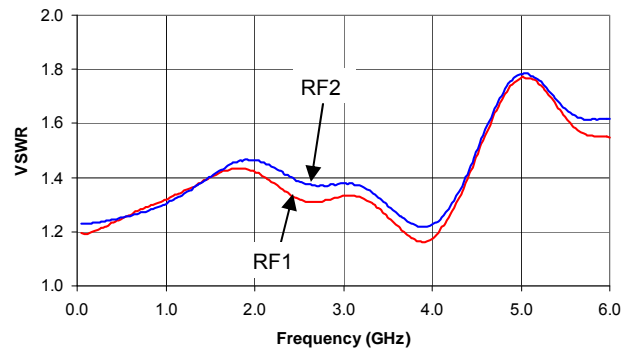

VSWR - 2 dB Bit vs. Frequency

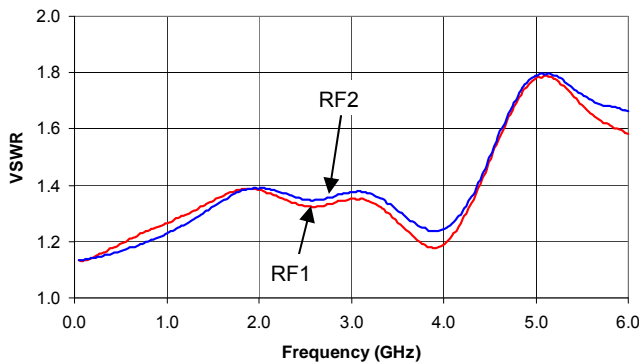

VSWR - 4 dB Bit vs. Frequency

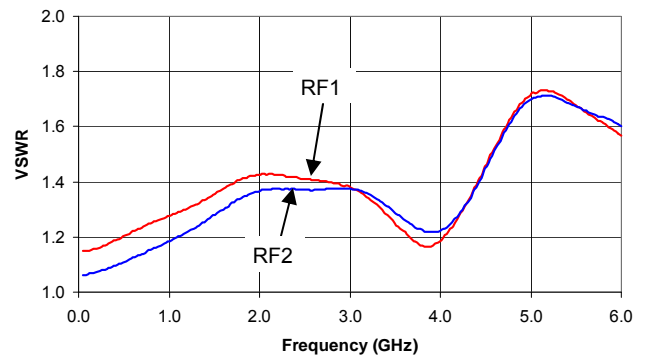

Typical Performance Curves

VSWR - 8 dB Bit vs. Frequency

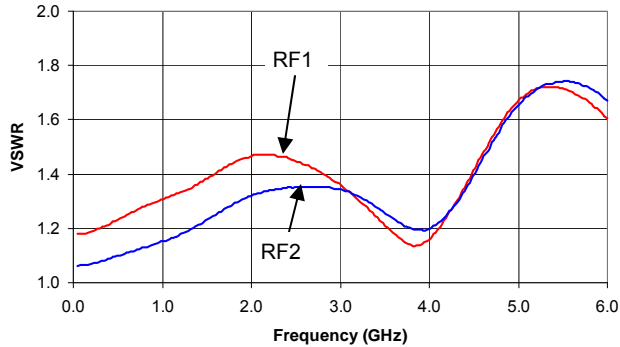

VSWR - 15.5 dB Attenuation vs. Frequency

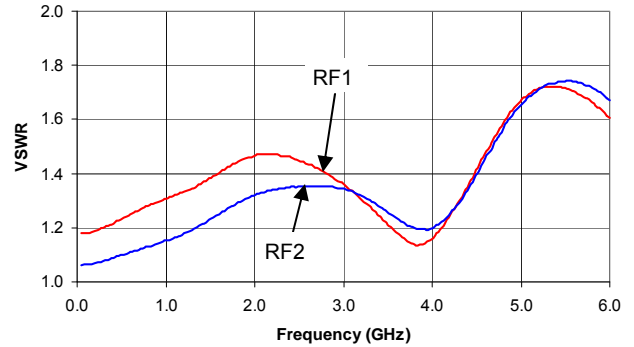

Typical Input IP2 and IP3 at Room Temperature¹¹

Attenuation	IP2			IP3			Units
	50 MHz	500 MHz	2 GHz	50 MHz	500 MHz	2 GHz	
Reference State	50	72	73	43	40	44	dBm
0.5 dB	51	73	74	43	41	44	dBm
1 dB	51	73	75	43	41	44	dBm
2 dB	51	73	74	43	41	45	dBm
4 dB	51	73	74	43	41	45	dBm
8 dB	50	71	75	41	43	41	dBm
15.5 dB	53	74	79	43	42	44	dBm

11. IP2 and IP3 are measured with two-tone inputs F1 and F2 up to +5 dBm with 1 MHz spacing.

CSP-1, 4 x 6 mm, 32-lead PQFN†

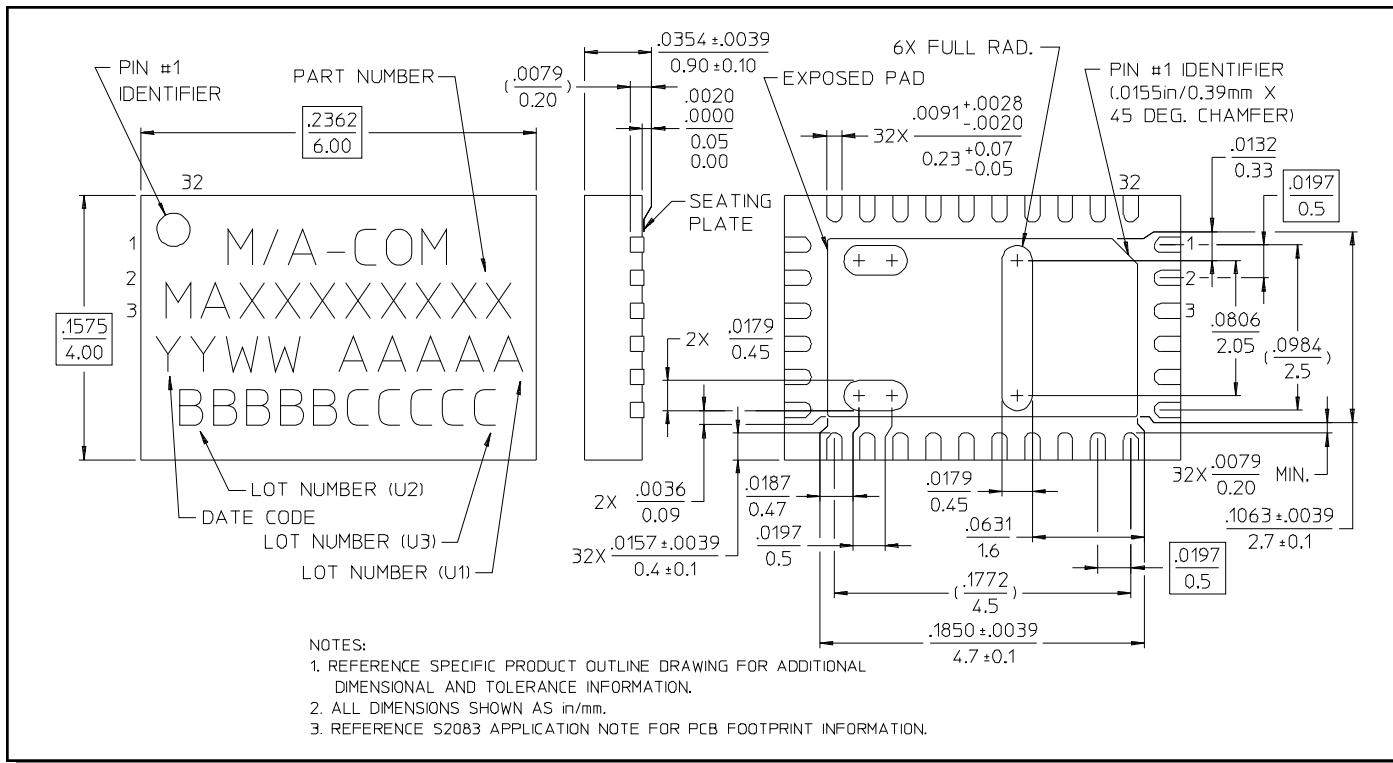

† Reference Application Note M538 for lead-free solder reflow recommendations.