

35

355099

RAST 2.5 connectors, pitch 2.5/5.0 mm

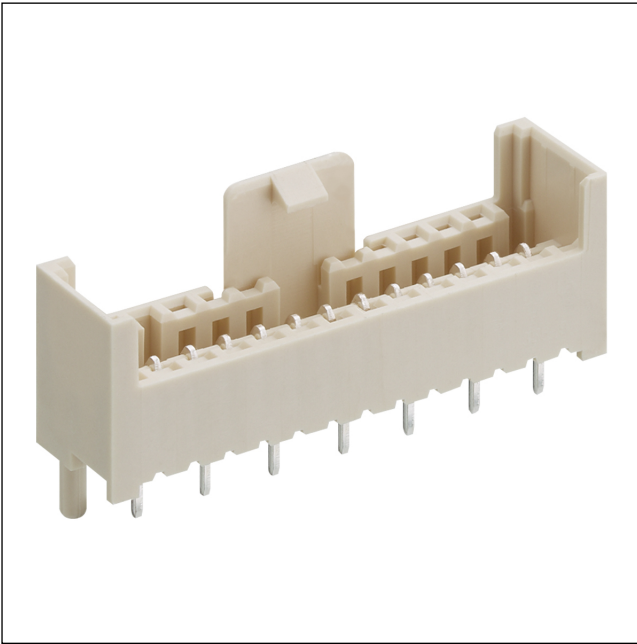

RAST-2.5-plus™ pin header, upright, with locking latch and positioning spigot, with double-sided keying
contact pitch 2.5 mm

State: Active

Approvals:



35 355099

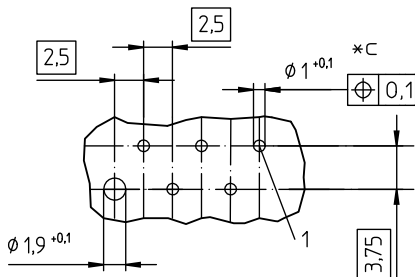
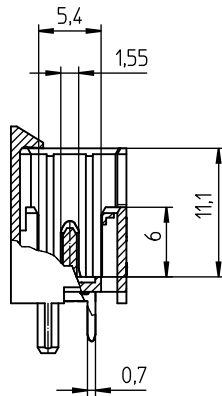
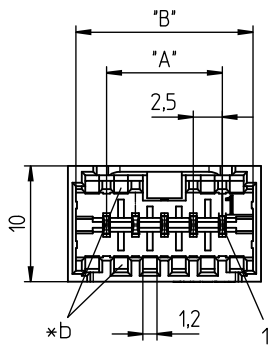
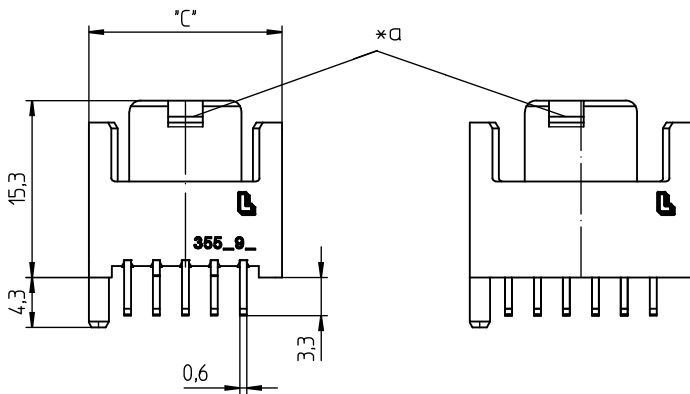

Environmental conditions

Temperature range -40 °C/+120 °C¹

¹ upper limit temperature (insulating body) RTI (electrical) of the UL Yellow Card

Materials

Insulating body PA GF, V-0 according to UL94¹
Contact pin CuZn, pre-nickel and tin-plated

¹ M12: component glow wire resistant (GWT 750 °C), testing acc. to IEC 60695-2-11, assessment acc. to IEC 60335-1 (flame < 2 s)



Mechanical data

Keying proposals at www.lumberg.com 

Electrical data (at T_{amb} 20 °C)

Rated current 4 A (T_u 60 °C)
2 A (T_u 100 °C)
Rated voltage 32 V AC
Material group IIIa (IEC)/2 (UL) (CTI ≥ 250)
Creepage distance 1,9 mm
Clearance 1,9 mm
Insulation resistance > 1 GΩ

Associated products

Counterparts  3521  3521-2  352100

35

355099

Designation	Pole Number	PU (Pieces)	MDQ (Pieces)	Dimensions		
				A (mm)	B (mm)	C (mm)
355099 03	3	1000	2000	5.0	10.1	11.7
355099 04	4	1000	2000	7.5	12.6	14.2
355099 05	5	1000	2000	10.0	15.1	16.7
355099 06	6	500	2000	12.5	17.6	19.2
355099 07	7	500	2000	15.0	20.1	21.7
355099 08	8	500	2000	17.5	22.6	24.2
355099 09	9	500	2000	20.0	25.1	26.7
355099 10	10	500	2000	22.5	27.6	29.2
355099 11	11	250	2000	25.0	30.1	31.7

Designation to be completed by further details (e.g. for keying, color or material options).

Packaging:

in bulk, in a cardboard box