

SERIES: PDQE20-D | **DESCRIPTION:** DC-DC CONVERTER**FEATURES**

- 20 W isolated output
- ultra-wide input voltage range
- single/dual regulated outputs
- 1500 Vdc isolation
- extended temperature range (-40~105°C)
- input under-voltage protection
- output short circuit, over-current, over-voltage protection
- DIP package
- EN 62368-1
- UL 62368-1



MODEL	input voltage		output voltage (Vdc)	output current		output power max (W)	ripple & noise ¹ max (mVp-p)	efficiency ² typ (%)
	typ (Vdc)	range (Vdc)		min (mA)	max (mA)			
PDQE20-Q24-S3-D	24	9~36	3.3	0	5000	16.5	100	88
PDQE20-Q24-S5-D	24	9~36	5	0	4000	20	100	90
PDQE20-Q24-S12-D	24	9~36	12	0	1667	20	100	90
PDQE20-Q24-S15-D	24	9~36	15	0	1333	20	100	91
PDQE20-Q24-S24-D	24	9~36	24	0	833	20	100	91
PDQE20-Q24-D5-D ³	24	9~36	±5	0	±2000	20	200	87
PDQE20-Q24-D12-D ³	24	9~36	±12	0	±833	20	200	90
PDQE20-Q24-D15-D ³	24	9~36	±15	0	±667	20	200	90
PDQE20-Q24-D24-D ³	24	9~36	±24	0	±417	20	200	89
PDQE20-Q48-S3-D	48	18~75	3.3	0	5000	16.5	100	88
PDQE20-Q48-S5-D	48	18~75	5	0	4000	20	100	90
PDQE20-Q48-S12-D	48	18~75	12	0	1667	20	100	91
PDQE20-Q48-S15-D	48	18~75	15	0	1333	20	100	91
PDQE20-Q48-S24-D	48	18~75	24	0	833	20	100	91
PDQE20-Q48-D5-D ³	48	18~75	±5	0	±2000	20	200	86
PDQE20-Q48-D12-D ³	48	18~75	±12	0	±833	20	200	90
PDQE20-Q48-D15-D ³	48	18~75	±15	0	±667	20	200	90
PDQE20-Q48-D24-D ³	48	18~75	±24	0	±417	20	200	90

Notes: 1. From 5~100% load, nominal input, 20 MHz bandwidth oscilloscope, with 10 μ F tantalum and 1 μ F ceramic capacitors on the output. From 0~5% load, ripple and noise is <5% V_o .

2. Measured at nominal input voltage, full load.

3. Dual output models are only CE certified.

4. All specifications are measured at $T_a=25^\circ\text{C}$, humidity < 75%, nominal input voltage, and rated output load unless otherwise specified.

OUTPUT (CONTINUED)

parameter	conditions/description	min	typ	max	units
cross regulation	dual output models: main output 50% load secondary output from 10~100% load			±5	%
start-up time	nominal input, constant resistive load		10		ms
adjustability ⁹	see application notes		±10		%
switching frequency ¹⁰	PWM mode		300		kHz
	3.3, 5 Vdc output models all other models		270		kHz
transient recovery time	25% load step change, nominal input voltage		300	500	µs
transient response deviation	25% load step change, nominal input voltage		±5	±8	%
	3.3, 5 Vdc output models		±3	±8	%
	±5 Vdc output models all other models		±3	±5	%
temperature coefficient	at full load			±0.03	%/°C

Note: 9. For single output models only.
10. Value is based on full load. At loads <50%, the switching frequency decreases with decreasing load

PROTECTIONS

parameter	conditions/description	min	typ	max	units
over voltage protection		110		160	%
over current protection	single output models	110	150	190	%
	dual output models	110	150	200	%
short circuit protection	hiccup, continuous, self recovery				

SAFETY AND COMPLIANCE

parameter	conditions/description	min	typ	max	units
isolation voltage	input to output for 1 minute at 1 mA	1,500			Vdc
	input/output to case for 1 minute at 1 mA	1,000			Vdc
isolation resistance	input to output at 500 Vdc	1,000			MΩ
isolation capacitance	input to output, 100 kHz / 0.1 V		2,000		pF
safety approvals ¹¹	certified to 62368-1: IEC, EN, UL				
conducted emissions	CISPR32/EN55032, class B (external circuit required, see Figure 3-b, 4-b)				
radiated emissions	CISPR32/EN55032, class B (external circuit required, see Figure 3-b, 4-b)				
ESD	IEC/EN61000-4-2, contact ±6 kV; air ±8 kV, class B (single output models)				
	IEC/EN61000-4-2, contact ±4 kV, class B (dual output models)				
radiated immunity	IEC/EN61000-4-3, 10 V/m, class A				
EFT/burst	IEC/EN61000-4-4, ±2 kV, class B (external circuit required, see Figure 3-a, 4-a)				
surge	IEC/EN61000-4-5, line-line ±2 kV, class B (external circuit required, see Figure 3-a, 4-a)				
conducted immunity	IEC/EN61000-4-6, 3 Vr.m.s, class A				
MTBF	as per MIL-HDBK-217F, 25°C	1,000,000			hours
RoHS	yes				

Note: 11. UL approval only on single output models.

ENVIRONMENTAL

parameter	conditions/description	min	typ	max	units
operating temperature	see derating curves	-40		95	°C
	3.3, 5 Vdc output models	-40		105	°C
storage temperature		-55		125	°C
storage humidity	non-condensing	5		95	%
vibration	10~150 Hz, 0.75 mm for 90 minutes on each axis		5		G

DERATING CURVES

TEMPERATURE DERATING CURVE
3.3, 5 Vdc output models

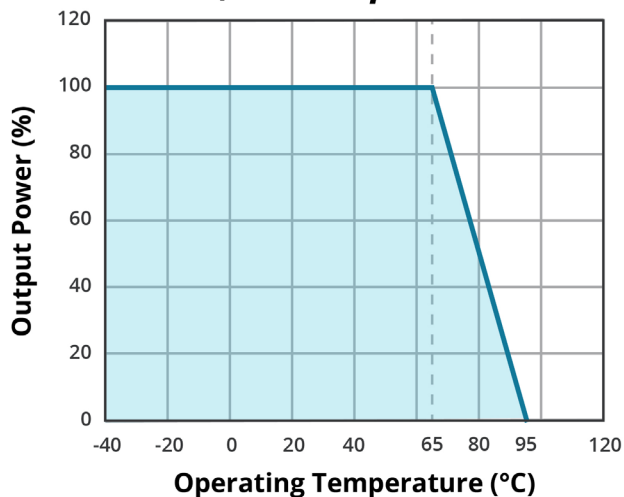

TEMPERATURE DERATING CURVE
±5 Vdc output models

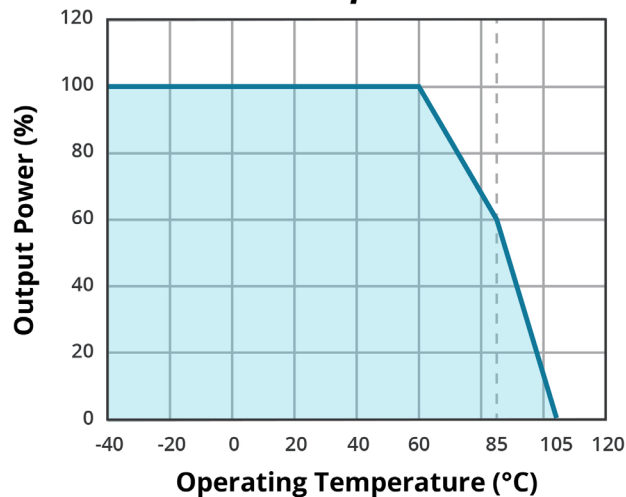

TEMPERATURE DERATING CURVE
all other output models

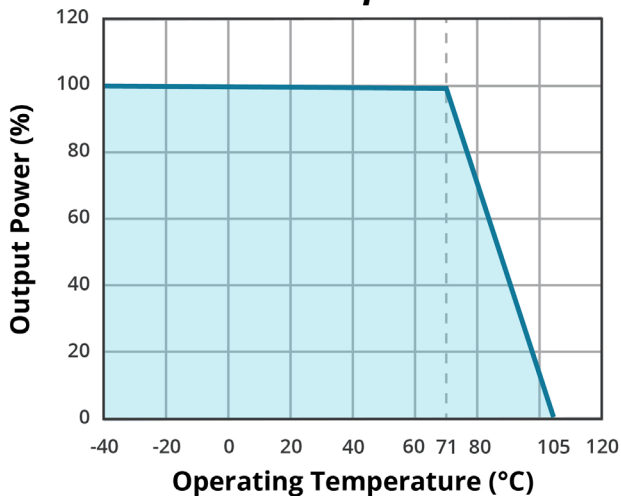

SOLDERABILITY

parameter	conditions/description	min	typ	max	units
hand soldering	1.5 mm from case for 10 seconds			300	°C
wave soldering	see wave soldering profile			260	°C

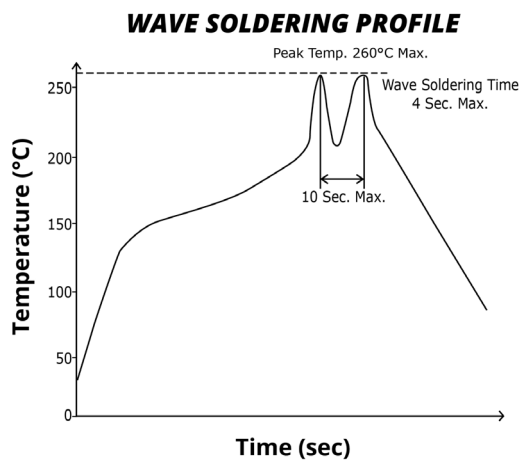

MECHANICAL

parameter	conditions/description	min	typ	max	units
dimensions	25.40 x 25.40 x 11.70 [1.000 x 1.000 x 0.461 inch]				mm
case material	aluminum alloy				
weight			15		g

MECHANICAL DRAWING

units: mm [inch]
tolerance: $\pm 0.50 [\pm 0.020]$
pin diameter tolerance: $\pm 0.10 [\pm 0.004]$

PIN CONNECTIONS		
PIN	Function	
	Single	Dual
1	CTRL	CTRL
2	GND	GND
3	V _{in}	V _{in}
4	+V _o	+V _o
5	trim	0V
6	0V	-V _o

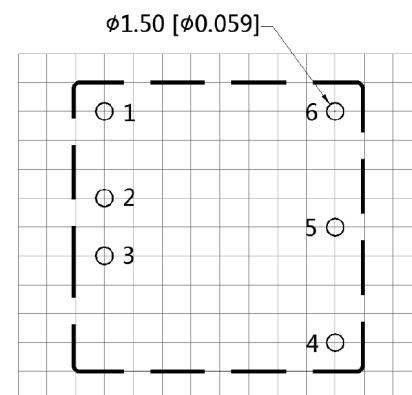
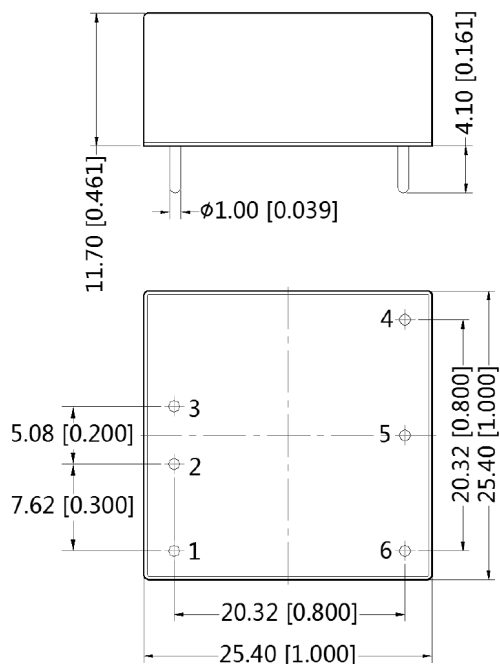

Note: Grid 2.54*2.54mm
Recommended PCB Layout
Top View

APPLICATION CIRCUIT

This series has been tested according to the following recommended circuits (Figures 1 & 2) before leaving the factory. If you want to further reduce the input and output ripple, you can increase the input and output capacitors or select capacitors of low equivalent series resistance provided that the capacitance is less than the maximum capacitive load of the model.

Figure 1
Single Output Models

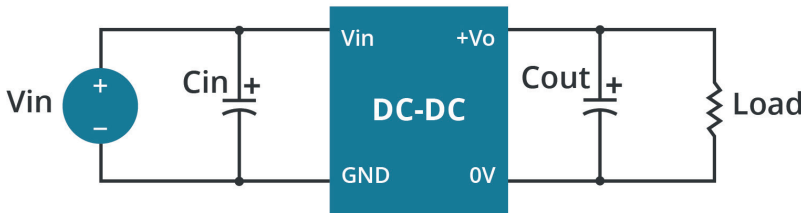

Table 1

Vout (Vdc)	Cin (μF)	Cout (μF)
3.3/5/12/15	100	100
24	100	47

Figure 2
Dual Output Models

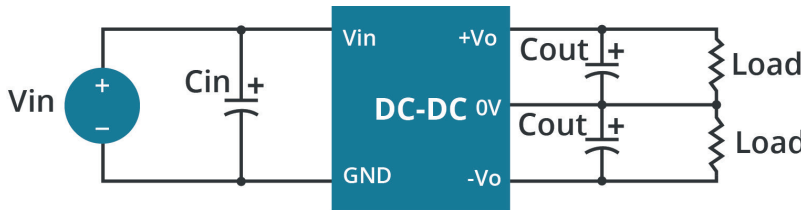

Table 2

Vin (Vdc)	Cin (μF)	Cout (μF)
24	100	10
48	10~47	10

EMC RECOMMENDED CIRCUIT

Figure 3
Single Output Models

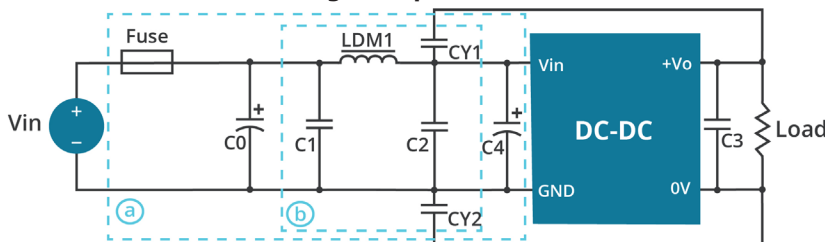

Table 3

Recommended External Circuit Components		
Vin (Vdc)	24	48
FUSE	choose according to actual input current	
C0, C4	330 μF / 50 V	330 μF / 100 V
C1, C2	4.7 μF / 50 V	4.7 μF / 100 V
C3	Refer to the Cout in Table 1	
LDM1	2.2 μH / 4 A	2.2 μH / 2 A
CY1, CY2	1 nF / 2 kV	

Figure 4
Dual Output Models

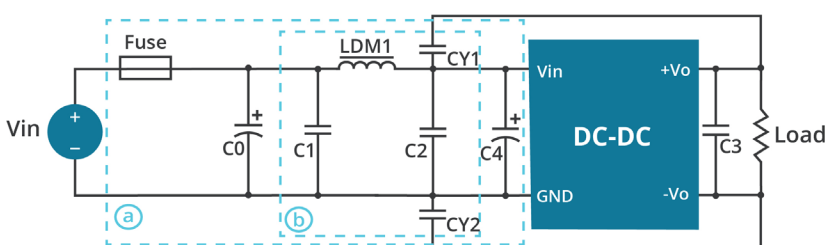

Table 4

Recommended External Circuit Components		
Vin (Vdc)	24	48
FUSE	choose according to actual input current	
C0, C4	330 μF / 50 V	330 μF / 100 V
C1, C2	4.7 μF / 50 V	4.7 μF / 100 V
C3	Refer to the Cout in Table 2	
LDM1	4.7 μH	
CY1, CY2	1 nF / 2 kV	

APPLICATION NOTES

Output voltage trimming
Leave open if not used.

Figure 5

Application Circuit for Trim pin
(part in broken line is the interior of models)

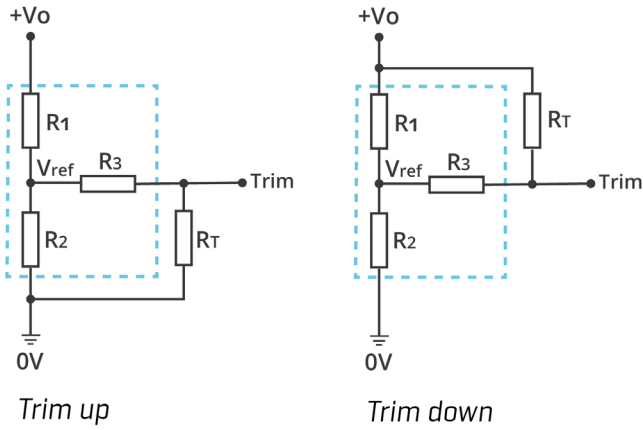

Formula for Trim Resistor

$$\text{up: } R_T = \frac{aR_2}{R_2 - a} - R_3 \quad a = \frac{V_{ref}}{V_{o'} - V_{ref}} \cdot R_1$$

$$\text{down: } R_T = \frac{aR_1}{R_1 - a} - R_3 \quad a = \frac{V_{o'} - V_{ref}}{V_{ref}} \cdot R_2$$

Note: Value for R1, R2, R3, and Vref refer to Table 5
 R_T : Trim Resistor
 a: User-defined parameter, no actual meanings
 $V_{o'}$: The trim up/down voltage

Table 5

Vout (Vdc)	R1 (kΩ)	R2 (kΩ)	R3 (kΩ)	Vref (V)
3.3	4.829	2.87	15	1.25
5	2.894	2.87	10	2.5
12	11.000	2.87	17.4	2.5
15	14.494	2.87	17.4	2.5
24	24.872	2.87	20	2.5

REVISION HISTORY

rev.	description	date
1.0	initial release	05/16/2019
1.01	safeties updated in features and safety line, packaging removed	01/14/2021
1.02	derating curves and circuit figures updated	08/23/2021
1.03	Vref updated for 3.3 Vdc output model	02/07/2022

The revision history provided is for informational purposes only and is believed to be accurate.



CUI INC

a bel group

Headquarters

20050 SW 112th Ave.
Tualatin, OR 97062
800.275.4899

Fax 503.612.2383
cui.com
techsupport@cui.com

CUI offers a two (2) year limited warranty. Complete warranty information is listed on our website.

CUI reserves the right to make changes to the product at any time without notice. Information provided by CUI is believed to be accurate and reliable. However, no responsibility is assumed by CUI for its use, nor for any infringements of patents or other rights of third parties which may result from its use.

CUI products are not authorized or warranted for use as critical components in equipment that requires an extremely high level of reliability. A critical component is any component of a life support device or system whose failure to perform can be reasonably expected to cause the failure of the life support device or system, or to affect its safety or effectiveness.