

Ultra Wide Bandwidth Amplifier

ZX60-14012L+

50Ω 300 KHz to 14 GHz

Features

- Wide bandwidth, 300 kHz to 14 GHz
- Reverse voltage connection protected
- Over-voltage transient protected
- Excellent flatness over frequency range, ± 1 dB typ.
- +11dBm typ. output power at 1dB compression
- Low cost
- Protected by US patent 6,790,049

Applications

- Broad band
- Buffer or low level driver
- General purpose
- Lab
- Instrumentation
- Test equipment



CASE STYLE: GC957

Connectors	Model
SMA	ZX60-14012L-S+

+RoHS Compliant

The +Suffix identifies RoHS Compliance. See our web site for RoHS Compliance methodologies and qualifications

Electrical Specifications at $T_{AMB} = 25^{\circ}\text{C}$

MODEL NO.	FREQ. (MHz) $f_L - f_U$	GAIN (dB)		MAXIMUM POWER (dBm)		DYNAMIC RANGE		VSWR (:1) Typ.		ACTIVE DIRECTIVITY (dB) Isolation-Gain	DC VOLTAGE @ Pin V+ (V) (Note 2)	DC OPERATING CURRENT @ Pin V+ (mA)				
		Typ.	Min.	Flatness Typ. Max.	Output (1 dB Comp.) Typ. Min. (Note 3)	NF (dB) (Note 1) Typ. Max.	IP3 (dBm) Typ.	In	Out			Typ.	Max.			
ZX60-14012L+	0.3-14000	12	9	± 1.0	± 2.0	11	9	5.5	7.5	20	1.3	1.7	4.5 - 8.5	12	62	68

1. Noise figure tested and guaranteed over the 10-14000 MHz range.
2. Unit is internally voltage regulated over 10.5 to 20 VDC input range.
3. +4 dBm min. power output @ 10000-14000 MHz

Maximum Ratings

Operating Temperature -40°C to 80°C case
 -40°C to 55°C ambient at 12V
 -40°C to 50°C ambient at 15V
 -40°C to 40°C ambient at 20V

Storage Temperature -55°C to 100°C

DC Voltage 20V

Input Power(no Damage) 10dBm

Permanent damage may occur if any of these limits are exceeded.



NOTE: When soldering the DC connections, caution must be used to avoid overheating the DC terminals. See Application Note [AN-40-10](#).

Outline Drawing

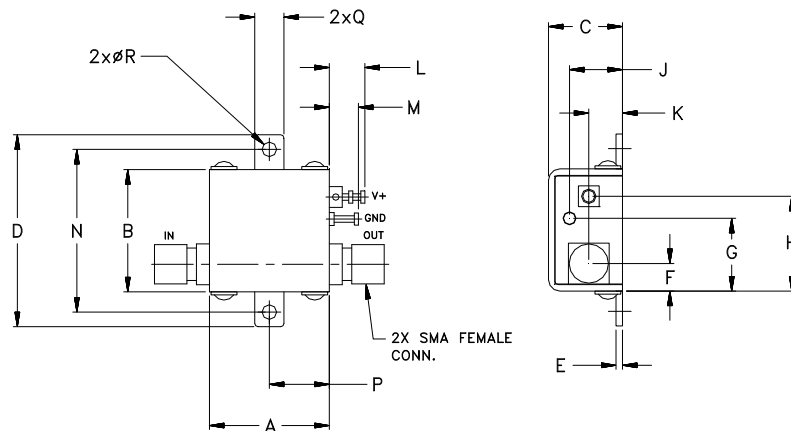

Outline Dimensions (inch/mm)

A	B	C	D	E	F	G	H	J	K	L	M	N	P	Q	R	WT.
.74	.75	.46	1.18	.04	.17	.45	.59	.33	.21	.22	.18	1.00	.37	.18	.106	GRAM
18.80	19.05	11.68	29.97	1.02	4.32	11.43	14.99	8.38	5.33	5.59	4.57	25.40	9.40	4.57	2.69	23.0

Notes

- A. Performance and quality attributes and conditions not expressly stated in this specification document are intended to be excluded and do not form a part of this specification document.
- B. Electrical specifications and performance data contained in this specification document are based on Mini-Circuit's applicable established test performance criteria and measurement instructions.
- C. The parts covered by this specification document are subject to Mini-Circuits standard limited warranty and terms and conditions (collectively, "Standard Terms"); Purchasers of this part are entitled to the rights and benefits contained therein. For a full statement of the Standard Terms and the exclusive rights and remedies thereunder, please visit Mini-Circuits' website at www.minicircuits.com/MCLStore/terms.jsp



www.minicircuits.com P.O. Box 350166, Brooklyn, NY 11235-0003 (718) 934-4500 sales@minicircuits.com

Typical Performance Data & Curves at 25°C ZX60-14012L+

FREQUENCY (MHz)	GAIN (dB)	DIRECTIVITY (dB)	VSWR IN (:1)	VSWR OUT (:1)	POWER OUT @1dB COMPRESSION (dBm)	IP3 (dBm)	NF (dB)
0.3	11.68	8.13	1.26	1.96	10.56	24.86	-----
10	11.29	7.89	1.19	1.72	10.99	25.44	5.21
500	11.31	7.86	1.21	1.71	10.88	25.08	4.83
750	10.99	8.57	1.21	1.67	11.03	25.55	5.03
1000	11.03	8.23	1.20	1.57	11.54	26.40	5.04
2000	11.72	7.03	1.26	1.51	12.37	28.02	4.72
3000	11.94	6.45	1.22	1.35	12.01	27.22	4.79
4000	12.87	4.67	1.14	1.24	13.22	25.58	4.93
5000	12.86	4.55	1.19	1.47	13.04	22.99	4.90
6000	12.71	4.76	1.24	1.67	13.04	21.14	5.00
7000	12.45	5.00	1.20	1.67	13.03	20.91	5.02
8000	12.55	5.35	1.34	1.65	12.25	17.80	5.23
9000	11.85	5.87	1.62	1.72	11.18	16.77	5.35
10000	11.98	5.84	1.81	1.77	10.57	14.99	5.75
11000	12.16	5.61	1.73	1.71	10.20	14.11	5.77
11500	12.19	5.41	1.64	1.73	9.35	12.73	5.86
12000	11.86	5.44	1.55	1.72	8.37	12.38	5.95
12500	11.89	5.59	1.48	1.69	7.78	12.27	5.96
13000	11.87	5.65	1.39	1.64	7.18	11.60	6.15
14000	11.41	5.97	1.19	1.39	6.98	10.94	6.19

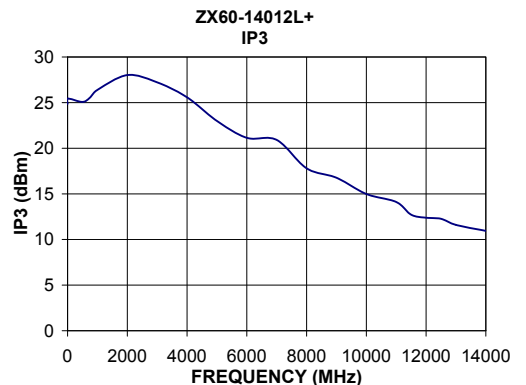
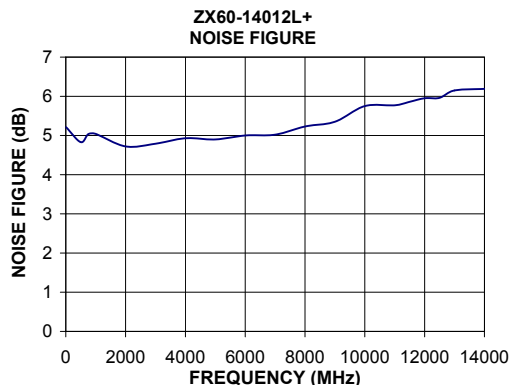
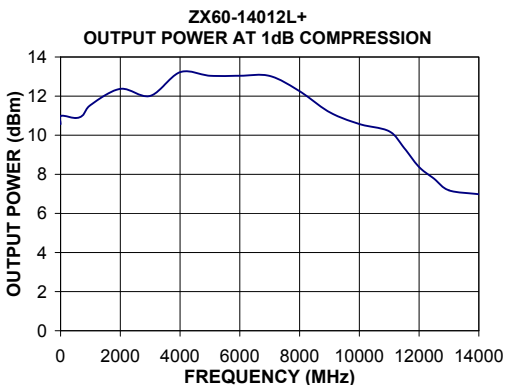
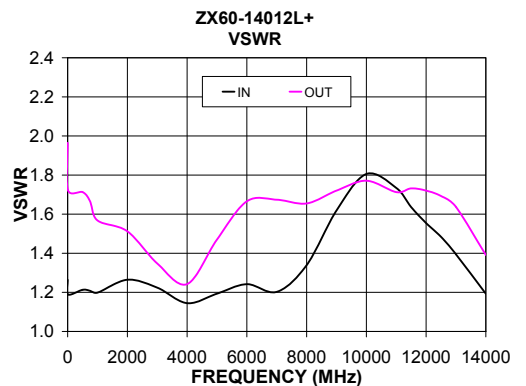
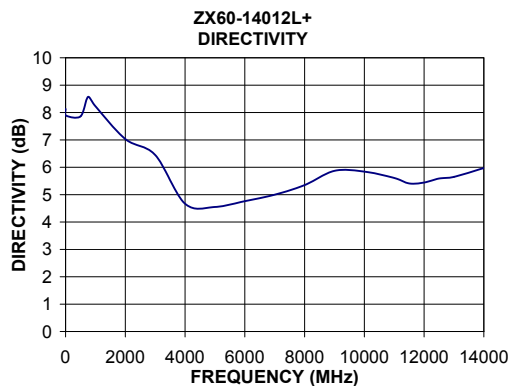
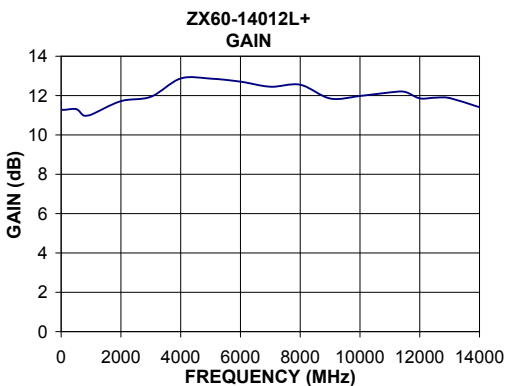

Notes

- A. Performance and quality attributes and conditions not expressly stated in this specification document are intended to be excluded and do not form a part of this specification document.
- B. Electrical specifications and performance data contained in this specification document are based on Mini-Circuit's applicable established test performance criteria and measurement instructions.
- C. The parts covered by this specification document are subject to Mini-Circuits standard limited warranty and terms and conditions (collectively, "Standard Terms"); Purchasers of this part are entitled to the rights and benefits contained therein. For a full statement of the Standard Terms and the exclusive rights and remedies thereunder, please visit Mini-Circuits' website at www.minicircuits.com/MCLStore/terms.jsp

